



Ente per le Nuove tecnologie,
l'Energia e l'Ambiente



Ministero dello Sviluppo Economico

RICERCA SISTEMA ELETTRICO

Descrizione di sistemi di purificazione e controllo dell'ossigeno per sistemi a piscina

Alessandro Gessi

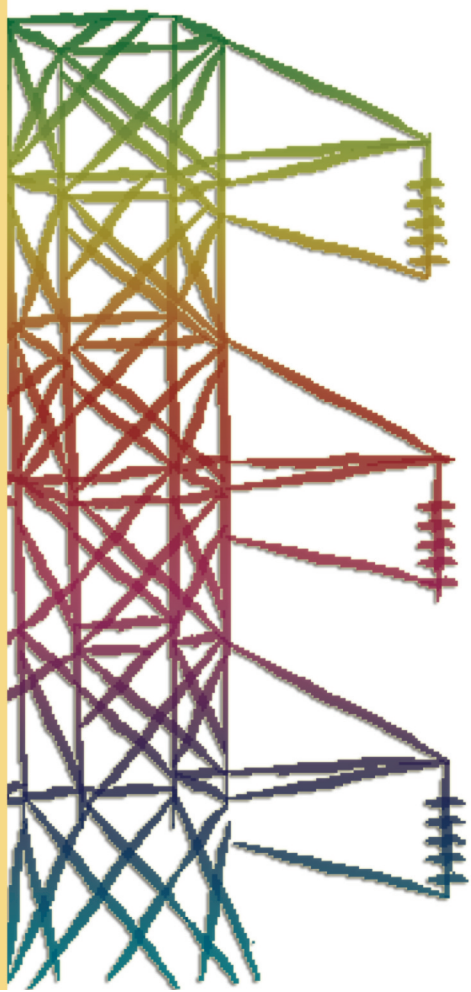



Ente per le Nuove tecnologie,
l'Energia e l'Ambiente



Ministero dello Sviluppo Economico

RICERCA SISTEMA ELETTRICO

Descrizione di sistemi di purificazione e controllo dell'ossigeno per
sistemi a piscina

Alessandro Gessi

DESCRIZIONE DI SISTEMI DI PURIFICAZIONE E CONTROLLO DELL'OSSIGENO PER SISTEMI A PISCINA

Alessandro Gessi (ENEA)

Marzo 2009

Report Ricerca Sistema Elettrico

Accordo di Programma Ministero dello Sviluppo Economico – ENEA

Area: Produzione e fonti energetiche

Tema: Nuovo Nucleare da Fissione

Responsabile Tema: Stefano Monti, ENEA

 FPN FIS ING Sezione Ingegneria Sperimentale	DESCRIZIONE DI SISTEMI DI PURIFICAZIONE E CONTROLLO DELL'OSSIGENO PER SISTEMI A PISCINA	DOCUMENT AdP ENEA-MSE LP3-D	ISSUE DATE 16/02/2009	PAGE 1 of 51
		IT-G-T-001	Rev : 3	

TITLE **DESCRIZIONE DI SISTEMI DI PURIFICAZIONE E CONTROLLO DELL'OSSIGENO
 PER SISTEMI A PISCINA**

AUTHOR Alessandro Gessi

CO-AUTHORS Mariano Tarantino, Egor A. Machula, J.L. Courouau (OECD NEA coll.)

SUMMARY Il presente documento raccoglie e sintetizza il lavoro di ricerca e sviluppo svolto da ENEA Brasimone, in collaborazione con altri laboratori europei, sulle tecnologie di controllo e monitoraggio dell'Ossigeno disciolto in metalli liquidi. Interesse particolare è rivolto allo sviluppo di sistemi per impianti a piscina.

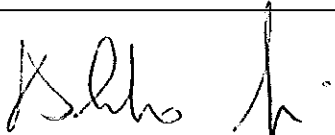
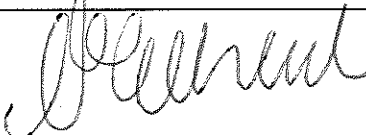
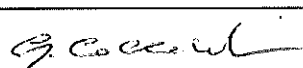
WRITTEN	CHECKED	APPROVED
A. Gessi	L. Moreschi	G. Coccoluto
		

 FPN FIS ING Sezione Ingegneria Sperimentale	DESCRIZIONE DI SISTEMI DI PURIFICAZIONE E CONTROLLO DELL'OSSIGENO PER SISTEMI A PISCINA	DOCUMENT AdP ENEA-MSE LP3-D	ISSUE DATE 16/02/2009	PAGE
		IT-G-T-001	Rev : 3	2 of 51

CHEMISTRY CONTROL AND MONITORING SYSTEMS

THE EU EXPERIENCE

The question of the impurities control and removal deals with the Lead alloys chemistry control and monitoring as regards the oxygen monitoring and the oxygen control processes, as well as the other impurities analysis by liquid metal sampling and control by purification processes.

The development of the heavy liquid metal chemistry control and monitoring is one of the issues that is critical for nuclear systems using lead alloys either as a spallation target or as a coolant. Indeed, the chemistry interacts with at least 3 operating specifications of any nuclear system:

1. The contamination control, to ensure stable hydrodynamics and heat transfer during service-life time that means to avoid lead oxide clogging or even corrosion products plugging due to mass transfer in a non isothermal system, to avoid deposits that eventually reduce the heat transfer capacity, etc.;
2. The corrosion control, to ensure sufficient resistance of the structural materials during the expected service life-time, which includes the self-healing oxide protection layers for iron-based alloys that requires oxygen control, etc.;
3. The radio-activation control, to ensure a safe management of the operations and maintenance phases;

These three requirements all refer to the chemistry control in lead alloys systems as regards the oxygen and others relevant impurities such as the corrosion products, spallation and activation products: control processes in relation with monitoring systems have to be developed and/or qualified for the application to a demo ADS system for both the coolant loop, refereeing to the primary circuit, as well as for the spallation target loop.

The principal scopes of development or validation concern at first the 2 following issues:

- The development of on-line monitoring systems for dissolved oxygen, as well as of the processes required to adjust the oxygen activity to a specified value;
- The characterisation of impurities and definition of purification process and monitoring method by liquid metal sampler and analytical techniques;

 Sezione Ingegneria Sperimentale	DESCRIZIONE DI SISTEMI DI PURIFICAZIONE E CONTROLLO DELL'OSSIGENO PER SISTEMI A PISCINA	DOCUMENT AdP ENEA-MSE LP3-D	ISSUE DATE 16/02/2009	PAGE
		IT-G-T-001	Rev : 3	3 of 51

These points will be detailed hereafter in the followings sections.

Oxygen control in lead and LBE systems

The oxygen is clearly the most important pollution for any lead alloy system, because of its potential pollution rate, as well as because of its consequences on the contamination by solid oxides, and its main impact on the corrosion rate of iron-based structures [Shmatko, 2000] [Zrodnikov, 2003] [Martynov, 2003] [Li, 2002].

Oxygen comes from the start up operations, from the maintenance phase or from the incidental pollutions: for the operating steps, the saturation of the oxygen is more than likely [Courouau, 2003a, 2005a]. To the opposite, its pollutions source should be negligible during normal operating mode. If the oxygen concentration must be adjusted to a specified value for corrosion control, the issue of implementing an oxygen pollution source arise. Contrarily, systems for oxygen purification would be necessary for start up, restart, or maintenance phases. The followings points that describe the requirements for operating a nuclear lead alloys system will be detailed hereafter:

1. The contamination of the coolant by coolant oxides;
2. The structure passivation by the self-healing oxide layer for enhancing the corrosion protection;
3. The requirement as regards oxygen for nuclear operations, including the way to determine the required oxygen concentration, as well as the necessary instrumentation and processes to achieve this specification.

Finally, the issue of the homogeneity of the oxygen, which is present in very low concentrations in the lead alloys, and submitted to various processes either consuming or releasing it, will be shortly discussed.

Contamination control

The coolant contamination by its oxides is defined by the solubility of oxygen in lead alloys, giving a maximum allowable oxygen chemical activity in the liquid metal. The available relations define theses limits for pure lead and LBE [Gromov, 1998]:

$$\text{Lead: } \log C_{o(\text{wt}\%)}^* = 3.2 - \frac{5000}{T_{(K)}} \quad \text{for } 400^\circ\text{C} < T < 700^\circ\text{C} \quad (4.5)$$

$$\text{LBE: } \log C_{o(\text{wt}\%)}^* = 1.2 - \frac{3400}{T_{(K)}} \quad \text{for } 400^\circ\text{C} < T < 700^\circ\text{C} \text{ known as the Orlov relation} \quad (4.6)$$

The accuracy of these relations is not reported, especially for temperature lower than the specified temperature range, although this data is one of the key parameter. It will have to be measured

 FPN FIS ING Sezione Ingegneria Sperimentale	DESCRIZIONE DI SISTEMI DI PURIFICAZIONE E CONTROLLO DELL'OSSIGENO PER SISTEMI A PISCINA	DOCUMENT AdP ENEA-MSE LP3-D	ISSUE DATE 16/02/2009	PAGE
		IT-G-T-001	Rev : 3	4 of 51

more accurately on a wider temperature range, as this relation is commonly extrapolated for the lower temperature. This tends to be confirmed by recent verifications [Ghetta, 2004] [Courouau, 2004a].

The main oxide formed in liquid LBE is lead monoxide, as it is the most stable oxide when compared to other lead oxides and bismuth oxides (PbO , PbO_2 , Bi_2O_3) [Gromov, 1998]. The lower oxygen chemical activity needed to avoid contamination is then defined by the lead monoxide solubility, although in case of a large oxygen pollution, both lead and bismuth oxides are formed.

In order to calculate dissolved oxygen concentration, the hypothesis of an ideal solution is often made, and the Henry's law is applied to the solute oxygen. Assuming solid lead monoxide as the standard state for the oxygen in lead-bismuth eutectic, the oxygen activity, a_o , shall be equal to unity when saturation is reached [Borgstedt, 1987]:

$$a_o = \frac{C_o}{C_o^*} \quad (4.7)$$

Where C_o is the dissolved oxygen concentration and C_o^* is the saturated oxygen concentration.

The operating specification to avoid any contamination of the coolant is then:

$$a_o \leq 1 \quad \text{or} \quad C_o \leq C_o^* \quad (4.8)$$

This specification must be ensured for all operating temperatures in any point of the loop, both in the liquid bulk as well as at the wall interface.

Compared to liquid sodium, the oxide formation threshold is rather low, as the following table illustrates it: the oxygen solubility in lead-bismuth eutectic alloy is 100 to 1000 times lower.

Oxygen solubilities¹ in sodium (Noden relation) and lead alloys expressed in $\mu\text{g/g}$.

	200°C	300°C	400°C	500°C	600°C	700°C
Lead	-	-	0.6	5.4	30	115
LBE	0.01	0.2	1.4	6.3	20	51
Na	12	97	415	1225	2821	5471

As main operating consequence, the safety margin is low, especially for the contamination by lead oxide and its potential risk of circuits clogging. Indeed, any tiny change in the chemical conditions of the coolant may induce oxide precipitation very quickly.

¹ concentration expressed in weight percentage converts to $\mu\text{g/g}$ (or ppm) by the multiplication by 10^4 or by addition of 4 in the log-type relation

 FPN FIS ING Sezione Ingegneria Sperimentale	DESCRIZIONE DI SISTEMI DI PURIFICAZIONE E CONTROLLO DELL'OSSIGENO PER SISTEMI A PISCINA	DOCUMENT AdP ENEA-MSE LP3-D	ISSUE DATE 16/02/2009	PAGE
		IT-G-T-001	Rev : 3	5 of 51

The lead oxide behaviour in the circuit is an important issue: ability to clog or to stay in suspension, ability to reach any free surface, because of its lower density than lead alloy, etc. This will determine where the oxide will first accumulate in case of pollution, as well as the long-term behaviour in tight system. Little is known on this behaviour up to now. However, unlike liquid sodium, lead alloys appear to allow the flow of a 2-phase solution, which give some relief for the operation. Indeed, solid impurities flowing in LBE were recorded at 0.15 weight% for reactor operation [Ivanov, 2003b], and between 3 to 6 weight% in loop operation [Courouau, 2005], without any specific difficulties for the latter case.

Corrosion control by self-healing oxides on iron-based alloys

Assuming that the structure is made of iron-based alloys, and that the corrosion protection is ensured by self-healing oxide layer, a second specification would then be related to its stability: ensure in any part of the system, both in the liquid bulk as well as at the wall interface, and for any operating condition that the conditions for the formation of iron oxide are fulfilled. Indeed, the magnetite being the least stable oxide of the layer, it defines the minimum allowable oxygen concentration. The reaction of the steel oxidation in liquid lead alloys is assumed to be as follows:

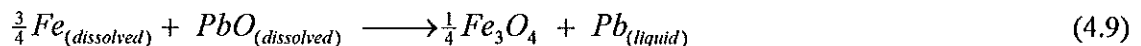

Where oxygen is supposed in solution in the form of dissolved PbO under its saturation limit. This is equivalent to consider that a cloud of Pb atoms surrounds the O atom. Dissolved oxygen chemical activity is then referring to dissolved PbO activity. Computed with the help of the HSC chemistry database (version 4.1) for the limited but relevant temperature range of 400K-1000K, the standard free enthalpy of reaction is then:

$$\Delta_r G^o_{(J/mol)} = -57190 - 21.1 \cdot T_{(K)} \quad (4.10)$$

Lead activity is equal to unity in pure lead solution, and is given by the following Russian relation in LBE solution reported in [Courouau, 2002b], which is slightly lower than 0.45:

$$\ln a_{pb} = -\frac{135.21}{T_{(K)}} - 0.8598 \quad (4.11)$$

The iron solubility in lead or lead alloys is expressed as [Gromov, 1998] [Tecdoc 1289]:

$$\text{Lead: } \log C^s_{Fe(wgt\%)} = 0.34 - \frac{3450}{T_{(K)}} \quad \text{for } 330^\circ\text{C} < T < 910^\circ\text{C} \quad (4.12)$$

$$\text{LBE: } \log C^s_{Fe(wgt\%)} = 2.01 - \frac{4380}{T_{(K)}} \quad \text{for } 550^\circ\text{C} < T < 780^\circ\text{C} \quad (4.13)$$

 FPN FIS ING Sezione Ingegneria Sperimentale	DESCRIZIONE DI SISTEMI DI PURIFICAZIONE E CONTROLLO DELL'OSSIGENO PER SISTEMI A PISCINA	DOCUMENT AdP ENEA-MSE LP3-D	ISSUE DATE 16/02/2009	PAGE
		IT-G-T-001	Rev : 3	6 of 51

Compared to liquid sodium [Teedoc 1289], the iron solubility is rather low as expected, but higher by one order of magnitude roughly.

Iron solubilities calculated in sodium and lead alloys expressed in µg/g.

T, °C	200°C	300°C	400°C	500°C	600°C	700°C
Lead	-	-	0.16	0.75	2.4	6.2
LBE	0.001	0.02	0.32	2.21	10	32
Na	0.0001	0.004	0.057	0.4	1.7	5.4

The activity product of the reaction of formation of magnetite in lead alloys is then as follows for equilibrium conditions:

$$\ln(a_{O_2} \cdot a_{Fe}^{3/4}) = \ln a_{pb} + \frac{\Delta_r G^0}{RT} \quad (4.14)$$

Defining the iron activity similarly to the oxygen activity, $a_{Fe} = C_{Fe} / C_{Fe}^*$, it is equal to one when the iron is saturated in the solution, and defining the minimum oxygen concentration required for effective corrosion protection, $C_{O_{min}}$ (in weight %), the following relations are derived:

$$\text{Lead: } \log C_{O_{min}(\%)} = -\frac{3}{4} \log C_{Fe(\%)} + 2.355 - \frac{10600}{T_{(K)}} \quad (4.15)$$

$$\text{LBE: } \log C_{O_{min}(\%)} = -\frac{3}{4} \log C_{Fe(\%)} + 1.2375 - \frac{9757}{T_{(K)}} \quad (4.16)$$

If the system enters the dissolution area, and if in situ oxide layers protect the structure, there will be a certain time lag corresponding to the time required to dissolve the magnetite and spinel oxide layers. This introduces a safety margin somehow. Conversely, when going back to the right oxygen level, there will be some delay. During these moments, the only measurement of oxygen is not enough, as oxygen concentration will keep stable, defined by the iron oxide chemical reaction equilibrium (buffering effect). The only way to detect if the oxide layer is dissolving or growing would be to measure directly its thickness using an electrical resistance probe measurement [Provorov, 2003].

Specifications for contamination and/or corrosion control

The oxygen concentration areas of operation to ensure both no contamination, required for any system, and possibly corrosion protection for iron based-alloys are almost similar for the liquid lead or the lead-bismuth eutectic:

ENEA FPN FIS ING Sezione Ingegneria Sperimentale	DESCRIZIONE DI SISTEMI DI PURIFICAZIONE E CONTROLLO DELL'OSSIGENO PER SISTEMI A PISCINA	DOCUMENT AdP ENEA-MSE LP3-D	ISSUE DATE 16/02/2009	PAGE
		IT-G-T-001	Rev : 3	7 of 51

$$C_{o\min} \leq C_o \leq C_o^* \quad (4.17)$$

Then, the operating specifications for oxygen can be evaluated from the following Figure drawn with the previous relations, for LBE for instance. The minimum oxygen concentration required to ensure the oxide layer stability is plotted against the saturated iron content, which maximizes the oxidation area as for lower iron concentration the minimum oxygen concentration increases. For an isothermal system, a vertical line plotted at the system temperature defines the oxygen range that is allowed: as illustrated in the figure, a system operating at 420°C is giving an oxygen range of $2.5 \cdot 10^{-6}$ to 2 wt-ppm. In principle, for a non-isothermal system, the intersection of the two ranges defined by the vertical lines plotted respectively for the cold and the hot leg temperatures are defining the oxygen range. As illustrated in the figure, a system operating between 420°C and 540°C would then give an oxygen range of $6 \cdot 10^{-5}$ to 2 wt-ppm.

For non-isothermal system, the temperature at the interface is different from the bulk temperature, because of the heat transfer process. However, if the oxide layer protection is required, the minimum oxygen content must be ensured at the wall temperature, which defines the oxygen concentration range allowed for operation for a given system. For instance, in the BREST-300 like coolant, the operating conditions are: operating coolant temperature 420-540°C, maximum fuel clad temperature of 650°C, and minimum steam generator wall temperature of 200°C. Thus, the oxygen concentration must be kept lower than 0.01 wt-ppm to prevent coolant oxidation at 200°C and higher than 0.0005 wt-ppm to keep oxide protection at 650°C, that could be compared to the range defined only by the bulk temperatures: $6 \cdot 10^{-5}$ wt-ppm (420°C) to 2 wt-ppm (540°C) which is drastically larger. If the same kind of conditions are required for lead coolant, the range of oxygen to ensure no contamination and corrosion protection by iron oxide is 0.31 wt-ppm at 375°C and $2.6 \cdot 10^{-3}$ wt-ppm at 650°C, which is even narrower [Courouau, 2004b].

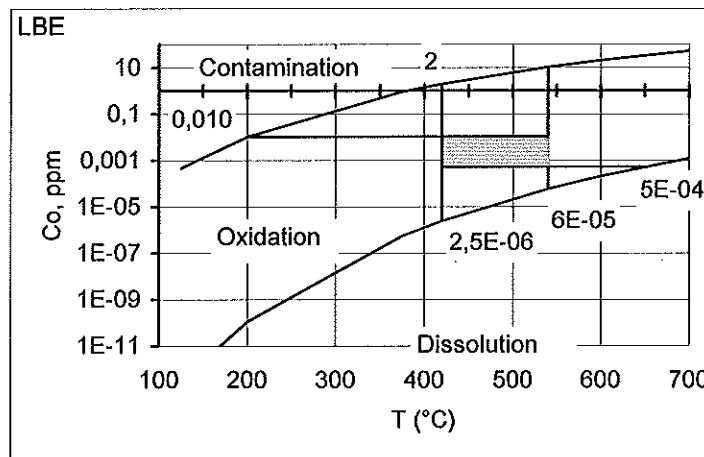

Oxygen specifications in LBE

for a BREST-300 like primary coolant, showing in shaded area the allowable oxygen operating range, as well as the contamination ($C_o = C_o^*$), the oxidation ($C_{o\min} < C_o < C_o^*$) and the reduction ($C_o < C_{o\min}$) areas [Courouau, 2004b].

However, the condition that iron is present in saturated condition is foreseeable in static condition, but unlikely in dynamic loop condition where mass transfer will play a role. Indeed, in a

 FPN FIS ING Sezione Ingegneria Sperimentale	DESCRIZIONE DI SISTEMI DI PURIFICAZIONE E CONTROLLO DELL'OSSIGENO PER SISTEMI A PISCINA	DOCUMENT AdP ENEA-MSE LP3-D	ISSUE DATE 16/02/2009	PAGE 8 of 51
		IT-G-T-001	Rev : 3	

non-isothermal system, the iron will be released from the hot structural wall by corrosion, and transferred to locations with lower temperature, where it may precipitate. The diffusion and the convection processes are the 2 mechanisms responsible for the mass transfer: usually, the diffusion of the species from the wall to the liquid bulk through the boundary layer is the limiting process. This latter includes the diffusion through the oxide layer when it is present. The thermodynamic condition for oxide formation on the interface can then be quite different from the condition in the liquid bulk, which is the result of a dynamic equilibrium. The following figure illustrates this: decreasing the iron concentration reduces the oxidation area, the higher the temperature the higher the reduction. For working at higher temperature, the oxygen content should then be close to its saturation limit. Indeed, the iron in equilibrium with its oxide at the wall interface can then be several orders of magnitude lower than its solubility, which reduces in turn the corrosion rate to low or very low level. This is the working mechanism behind the active oxygen control and the oxide film formation [Li, 2002].

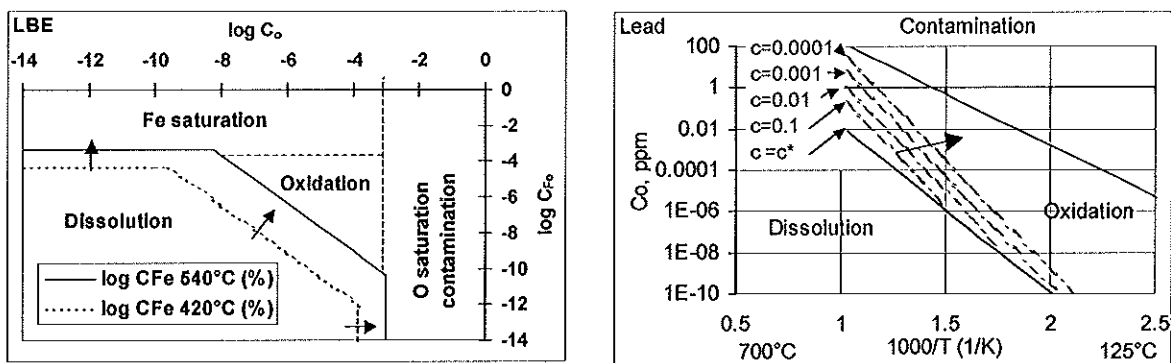

Oxygen Oxide formation threshold defining the couple of solution to ensure a protective oxide layer depending on both the iron (c) and oxygen concentrations, in LBE and lead, expressed in weight% and ppm respectively.

The iron concentration is difficult to measure and impossible to monitor on-line up to now. The lower detection limit is 5 wt-ppm for chemical analysis up to now, and could possibly be lowered to 0.5 wt-ppm, which may still be higher than the iron concentration expected. There is no straight solution to control the iron content, but oxygen should be controlled and monitored on-line so that it gives at least the hand on one parameter. As a consequence, the oxygen specification should be set at the highest possible value that complies with the contamination requirement, which corresponds to the cold leg temperature interface, as this is maximizing the oxidation area for an unknown iron concentration, which is defining the specification for oxygen control:

$$C_o \left(\text{Contamination} / \text{and corrosion control} \right) = C_o^* (\text{Cold leg wall Temperature}) \quad (4.18)$$

From the previous example, the oxygen concentration specification chosen would then be 0.01 wt-ppm.

 FPN FIS ING Sezione Ingegneria Sperimentale	DESCRIZIONE DI SISTEMI DI PURIFICAZIONE E CONTROLLO DELL'OSSIGENO PER SISTEMI A PISCINA	DOCUMENT AdP ENEA-MSE LP3-D	ISSUE DATE 16/02/2009	PAGE 9 of 51
		IT-G-T-001	Rev : 3	

This thermodynamic analysis was made thanks to some assumptions, and could be more or less well applied to perlite steel (Fe 100%), but might be slightly different for Cr alloyed steel for instance, as the oxide layer will be a compound of oxides. Real operating limits should be measured on test facilities in representative operating conditions and for relevant materials.

Policy for a nuclear system

The contamination represents the main risk during the initial operations (first filling, start-up...) [Ivanov, 2003a] [Courouau, 2004c, 2005a], as well as during the maintenance and repair phases: air ingress can happen and the oxygen is released from the structural materials as well as from the LBE itself. It is critical to ensure that the liquid metal is kept clean and that no solid oxides are formed, as these could clog narrow sections of the facility, or deposit on heat exchanger surface, so that the overall cooling capacity of the system can be affected. Known major oxide slag's formation failures are dated back from the sixties: the initial run of the KV/27 land nuclear reactor based at IPPE and the project 645 nuclear submarine failure on cruise [Ivanov, 2003b]. For the latter, a sudden ingress of slag's in the core during sea trials in 1968 caused a loss of power by negative temperature reactivity effect. The crew tried to restore the power by levelling off the control rods that led to partial melting of the core. In fact, there were at least two sources of pollution for the coolant: the oxygen accumulated during the maintenance phases and the oil pollution from the rotating shaft of the primary pumps. As there were no quality-monitoring devices, nor process for purification, the slow ongoing pollution and accumulation could not be detected nor treated.

By contrast, during the normal operating mode, the oxygen pollution sources are then negligible, so that, because of the various source of consumption of the oxygen, one can expect low or very low oxygen content in the liquid metal loop [Shmatko, 2000]. The corrosion control is then critical during that operating period, to prevent a too large dissolution of the structural material as well as a too large oxide layer growth that could be peeled off the structural interface.

The oxygen control is then a basic requirement for nuclear relevant system, for which long service lifetime is expected, meaning interventions for components and fuel handling, repair and maintenance, requiring a purification of the oxygen before any restart, together with a requirement for a as high as possible operating temperature, which might require the corrosion control by self-healing oxides layer on the structural iron-based materials.

The main phases of the operation are divided by:

1. Start-up and initial purification to reduce any lead monoxide present in excess,
2. Possibly, the initial passivation of the structures after their assembly to promote the formation of a protective oxide layer,
3. Normal operating conditions to keep the oxygen low enough to avoid contamination, and possibly high enough to compensate for its consumption in the circuits.

 FPN FIS ING Sezione Ingegneria Sperimentale	DESCRIZIONE DI SISTEMI DI PURIFICAZIONE E CONTROLLO DELL'OSSIGENO PER SISTEMI A PISCINA	DOCUMENT AdP ENEA-MSE LP3-D	ISSUE DATE 16/02/2009	PAGE 10 of 51
		IT-G-T-001	Rev : 3	

The first requirement consists in ensuring the contamination control in any part of the circuit and for any operating condition, in order to avoid the oxides formation of firstly the coolant oxides, as well as possibly, the corrosion control. This function is usually referred to as the oxygen control.

If no corrosion control is strictly required, the contamination specify the upper threshold for the oxygen control as follows:

$$C_o(\text{Contamination control only}) \leq C_o^*(\text{Cold leg wall Temperature}) \quad (4.19)$$

This could be the case when no iron-based alloys, such as ceramic or refractory metal, are used for the structure, or when the conditions for operations, temperature and service lifetime, are sufficiently low enough to be compatible with the corrosion kinetics [Balbaud, 2001]. This choice was made for instance for the MEGAPIE target: the following figure represents the expected oxygen concentration during its service lifetime, from its start-up tests to the on-beam operations. Its service lifetime was assessed as compliant with the corrosion that could be assessed at the operating temperature with very low oxygen concentration. Fig 4.3.3 clearly indicate that these conditions would be achieved after a certain delay, necessary for the residual oxygen present in the liquid bulk as well as the residual oxide layer on the steels to dissolve, which may takes weeks or months, and thus limiting the corrosion further on.

Oxygen expected behaviour for the MEGAPIE target during start-up operation (integral test stand - MITS), and during on beam steady state operation where the oxygen will be reduced first down to the iron oxide stability threshold, and then even further down when all iron oxide will be reduced after an undefined delay [Courouau, 2005a].

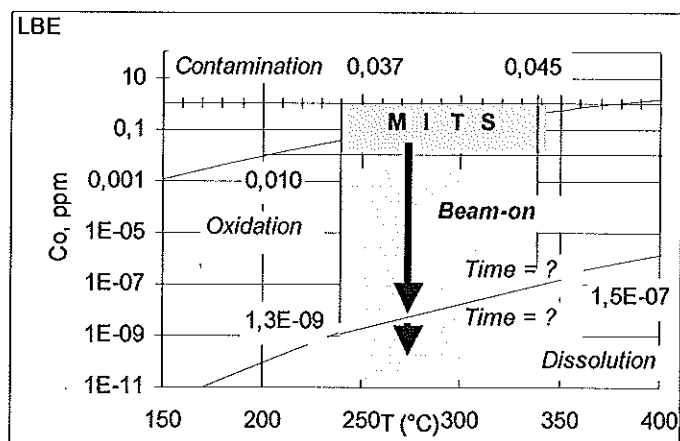

For any nuclear lead alloys circuits, it is then necessary to provide the following systems for the oxygen control:

- Oxygen measurement systems in both the liquid and the gas phase;
- Oxygen control processes in the liquid phase;

 FPN FIS ING Sezione Ingegneria Sperimentale	DESCRIZIONE DI SISTEMI DI PURIFICAZIONE E CONTROLLO DELL'OSSIGENO PER SISTEMI A PISCINA	DOCUMENT AdP ENEA-MSE LP3-D	ISSUE DATE 16/02/2009	PAGE
		IT-G-T-001	Rev : 3	11 of 51

Indeed, the oxygen will behave accordingly between the gas and the liquid phase in normal operating condition, where equilibrium will be reached most certainly. As the main pollution sources are not part of normal operation, it is important to be able to detect the transient due to pollution as soon as possible. As the transient could be very different from one phase to another, because of the large difference in volume, the oxygen measurement in both media is required. This was the main lesson learnt from the 1990 air pollution at SUPERPHENIX, where only liquid metal quality sensor was implemented. Since then on, gas chromatography of the cover gas allows detecting any variation of nitrogen content that will allow to detecting any air ingress quickly, as the oxygen reacts quickly with sodium. The same kind of reasoning applies as well for steam measuring device: location in the gas phase in order to detect quickly any water leak.

The oxygen control processes will be briefly detailed hereafter.

The oxygen monitoring system for the liquid metal bulk, also referred to as the oxygen sensor, is part of a complete development in itself and will be detailed latter on. Measuring device for the oxygen in the gas phase are commercially available (ZIROX...).

Oxygen control processes

Processes for the oxygen control in a lead bismuth systems are basically of 2 different kinds:

- o Gas phase control;
- o Solid phase control;

The principle of the gas phase control is based on gas/liquid equilibrium between the cover gas and the liquid bulk when the liquid is below saturation. Controlling the oxygen partial pressure in the gas phase would set the dissolved oxygen content.

In practice, pure oxygen or hydrogen are flowed in the cover gas, usually in dilution with argon, which is easy to achieve over flowing liquid in vessel, provided the interface is well mixed, or directly with the help of a bubbling line for a larger exchange area, in order to oxidise or reduce the liquid lead alloys according to the following reactions:

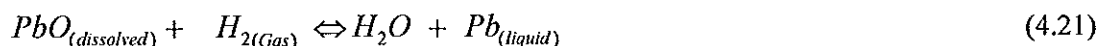

The water produced by the reaction is evacuated through the vent line.

For the contamination control, the use of hydrogen gas allows recovering from oxides accumulation after a large pollution, for star-up or maintenance, or after prolonged operations in order to restore the thermal-hydraulic performances of the system. This is considered as a basic process common to all facilities. The use of getter addition, such as Zr, or Mg, will reduce the oxygen to the

ENEA FPN FIS ING Sezione Ingegneria Sperimentale	DESCRIZIONE DI SISTEMI DI PURIFICAZIONE E CONTROLLO DELL'OSSIGENO PER SISTEMI A PISCINA	DOCUMENT AdP ENEA-MSE LP3-D	ISSUE DATE 16/02/2009	PAGE
		IT-G-T-001	Rev : 3	12 of 51

low concentration but produce other solid oxides that would have to be purified somehow. Hydrogen presents the main advantages to produce only a gaseous reaction product that is easily evacuated in practice. An illustration of a reduction with hydrogen cover gas is given in Fig. 4.3.4.

For the corrosion control by self-healing oxide on iron-based alloys, the control of a fixed concentration in dissolved oxygen is required in a quite tight operating range. This can be achieved by controlling the ratio of steam over hydrogen [Lefhalm, 2001] [Mueller, 2000, 2003], for instance, that fix the third variable of the system, the oxygen concentration in the liquid bulk according to the second chemical reaction. In principle, the use of other reaction system could be used, such as the CO/CO₂ system, but are not favoured for practical and safety reason.

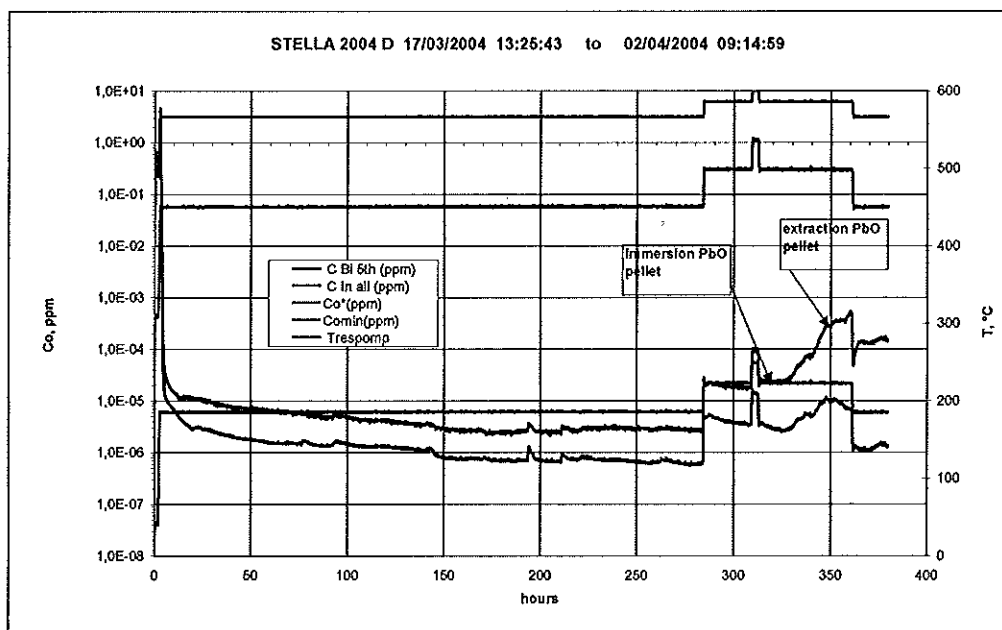

Hydrogen reduction on the STELLA loop, starting from saturation (C_o^* , down to the $C_{o\min}$ assessed for $a_{Fe}=1$, in isothermal condition whose temperature is given by $T_{respomp}$) followed by PbO pellet dissolution test at 500°C.

For the gaseous processes, the process parameters are related to the mass exchange at the gas-liquid interface that limits the equilibrium process. Bubbling, which increases the exchange area greatly, favours the exchange, and then the time to reach the thermodynamic equilibrium. Temperature is the second main parameter for the hydrogen reduction of solid lead oxide [Ricapito, 2002], the higher the better, which might be related to the solubility. To the opposite, the oxidation is fast, which may lead to solid oxide formation rather than dissolved oxygen, which can be transferred and settled in other part of the facility, and then requiring subsequent purification. This is why oxidation at a slower rate is better achieved when adjusting directly the gas phase composition, as it is required for normal operating conditions of a gas tight system.

 FPN FIS ING Sezione Ingegneria Sperimentale	DESCRIZIONE DI SISTEMI DI PURIFICAZIONE E CONTROLLO DELL'OSSIGENO PER SISTEMI A PISCINA	DOCUMENT AdP ENEA-MSE LP3-D	ISSUE DATE 16/02/2009	PAGE
		IT-G-T-001	Rev : 3	13 of 51

To avoid the oxidation in excess and the solid oxide formation within the system, solid mass exchange was proposed [Gromov, 1996] [Zrodnikov, 2003]. It consists in dissolving solid lead oxide, which physical form is mechanically stable such as in pellet (Fig 4.3.5), in a device where the thermal-hydraulics is controlled. Indeed, the dissolution rate is depending on temperature and flow rate [Askhadulline, 2003, 2005] [Simakov, 2003], which give rise for the automated control of the oxygen by adjusting the consumption due to the oxidation with the pollution rate delivered to the system. The solid mass exchanger unit can be designed as a consumable item or for the whole service lifetime of small device such as spallation target, avoiding the handling requirement. Such a system will spare the needs for a complex gas circuits to be operated in a nuclear environment, except probably a regular venting out of the spallation residues, thus enhancing the confinement and the overall safety of the system.

Lead monoxide pellets fabricated for the STELLA loop.

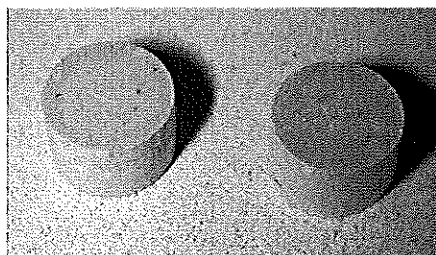

As a general operating feedback gained from oxygen control operations, the sources of oxygen pollution alongside the sources of its consumption due to its interactions with other impurities within particular facility (corrosion products, protons, beam, spallation residues, etc...) should be better known and understood, in order to be able to design a reliable unit for controlling the level of oxygen in a specified intermediate range on the long term [Courouau, 2004b].

However, the main achievement up to now about the oxygen control process is that its feasibility for small-scale systems is now considered as demonstrated: a reducing condition is quite straightforward to achieve by hydrogen flowing or bubbling (kinetics measured), or, even by getter addition, if the loop presents some filtration system or areas where oxides could be left sedimented at the free interface. In addition, a specified medium range oxygen concentration could be set by the gas phase either by a defined gas mixture or by a separate addition of oxygen (air) or hydrogen. Basic know-how and processes on the liquid metal chemistry control is then available at the loop scale conditions, but further progresses are awaited from the use in larger loops such as for the primary circuit, and especially optimization and further qualification, as for instance:

1. For the H_2O/H_2 gaseous mixture process, the validation of the mass transfer across the gas-liquid interface and the scaling-up is required for an efficient oxidation rate;
2. For the separate addition of H_2/O_2 , further validation for intermediate oxygen concentration is required, in order to determine whether a stable oxygen level can be controlled or not by this method;

 FPN FIS ING Sezione Ingegneria Sperimentale	DESCRIZIONE DI SISTEMI DI PURIFICAZIONE E CONTROLLO DELL'OSSIGENO PER SISTEMI A PISCINA	DOCUMENT AdP ENEA-MSE LP3-D	ISSUE DATE 16/02/2009	PAGE 14 of 51
		IT-G-T-001	Rev : 3	

- For the solid PbO dissolution process, further process data for the effective dissolution rates (Temperature, flow rate) must be measured in relevant operating conditions and the pellet fabrication procedure must be validated [Askhadulline, 2005] [IP-eurotrans, 2004].

As the oxygen is present at very concentrations, as and the rates of potential transfer such as pollution or consumptions are relatively large, there is a need for larger scale testing for process reliability assessment, as regards the homogeneous distribution of the oxygen. This is especially required to be demonstrated for the transient operating mode, in order to validate first the feasibility of the contamination control on large scale systems, as well as possibly the corrosion protection, for any part of the system and for any operating conditions.

The homogeneity issue

Considering the oxygen as perfectly homogenized within the circuit [Shmatko, 2000] [Orlov, 2005], i.e. that there is no limitation due to the mass transfer (convection and diffusion), the oxygen concentration is assumed to be constant over the whole system: only one measure is then sufficient, and should be made at the highest temperature, where the sensor is the most efficient. As this could be different, recommendation is to implement sensor both in the cold and hot leg section at least.

The condition for oxygen homogeneity within a given system is, however, questionable. In the case of the corrosion protection, the oxygen range will be rather low, so that the process will only be qualified if the oxygen behaviour is controlled over all part of the circuits for all operating conditions: no lower oxygen spots where corrosion could happen, nor higher oxygen spots where oxide can built up. This depends on the various convection and diffusion data for oxygen in lead alloys system, which is presently poorly known. However, low oxygen diffusivity in lead alloys could be compensated for by high convection in the system, which ensures homogeneous stirring of the liquid metal.

In small scale systems, such as SVBR-75 [Toshinsky, 2000] or the Angstrom concepts [Tecdac 1056], the liquid is renewed hundreds of times per hours, as illustrated in the following table, so that the liquid phase can be assumed as perfectly stirred and homogeneous. In addition, as the volume of the coolant is small, there should be no stagnation zones. However, the highest flow velocity does not exceed 2 m/s on the fuel-cladding walls.

For larger system the homogeneity might not be ensured, especially because the convection is lower. For instance, from all the pool-type liquid metal reactors, such as BREST or sodium-cooled reactors, the renewal rates are 10 times lower than for the small-scale reactors. These large reactors hold considerably larger coolant volume. The second explanation is the very compact and small reactor design of both SVBR and Angstrom, which are primarily coming from the naval propulsion systems.

Dealing with renewal rate, the circulation loop type reactor, compared to pool type, which hold up less coolant volume are more efficient (PWR as well).

 FPN FIS ING Sezione Ingegneria Sperimentale	DESCRIZIONE DI SISTEMI DI PURIFICAZIONE E CONTROLLO DELL'OSSIGENO PER SISTEMI A PISCINA	DOCUMENT AdP ENEA-MSE LP3-D	ISSUE DATE 16/02/2009	PAGE 15 of 51
		IT-G-T-001	Rev : 3	

Typical design parameters for core coolant circulation for various reactors.

	Core flow rate	Primary coolant	Renewal rate	Temperature
PHENIX – 350 MWe (Na)	10260 t/h (3 * 0.95 t/s)	840 t	12 times/h	400-550°C (150°C)
SUPERPHENIX – 1500MWe (Na)	61056 t/h (4 * 4.24 t/s)	3250 t	19 times/h	395-545°C (150°C)
EFR – 1470 MWe (Na)	61170 t/h	2100 t	29 times/h	395-545°C (150°C)
PWR – 1300 MWe (light water)	68000 t/h	380 m3	179 times/h	286-323°C (37°C)
SVBR – 75 MWe (EPB)	3492 m3/h (11.18 t/s)	18 m3	194 times/h	275-439°C (164°C)
NPHP Angstrom - 30t (EPB)	382 m3/h	3 m3	127 times/h	280-465°C (185°C)
BREST-300 MWe (Pb)	143640 t/h (3.8 m3/s)	600 m3 (6300 t)	23 times/h	420-540°C (120°C)
BREST-1200 MWe (Pb)	570240 t/h (158.4 t/s)	2500 m3 (26250 t)	22 times/h	420-540°C (120°C)

Recommendation from [Shmatko, 2000] is to provide at the circuit design stage provisions to avoid any perturbation of the flow (junction, abrupt turns, etc.), and to exclude any stagnation zones. This would in principle limit the contamination.

However, the only possibility to validate a design for the Safety Authorities as regards the corrosion protection by self-healing oxide would be to model the mass transfer within the system. The basics data to ensure convection and diffusion of both oxygen and iron should be measured accurately [IP-Eurotrans, 2004] so as to provide data for the modelling [Zrodnikov, 2003] [Balbaud, 2001] [Li, 2002] of the corrosion/precipitation and mass transfer in all circuits. Then, models must be qualified on small and large-scale experiments in order to be able to design any system with enough reliability and safety.

On-line electrochemical oxygen sensor

The accurate measurement of the oxygen concentration in the liquid lead-bismuth eutectic, as well as in the pure lead alloys for use as coolant in nuclear systems or as liquid spallation target for high neutrons source or accelerator driven system is a critical issue for defining the active oxygen control that will first of all prevent the contamination of the liquid system by lead and bismuth oxides, as well as, possibly, to ensure an efficient corrosion protection of the iron based alloys structures if the self-healing oxide layer method is chosen.

 FPN FIS ING Sezione Ingegneria Sperimentale	DESCRIZIONE DI SISTEMI DI PURIFICAZIONE E CONTROLLO DELL'OSSIGENO PER SISTEMI A PISCINA	DOCUMENT AdP ENEA-MSE LP3-D	ISSUE DATE 16/02/2009	PAGE
		IT-G-T-001	Rev : 3	16 of 51

The use of the ionic conduction properties of some solid electrolyte, and in particular the zirconia based ceramic, allow to make electrochemical cell assembly that allows the measurement of dissolved oxygen in liquid metal system. This is known as the electromotive force measurement in open circuit or as the galvanic cell method.

This technique presents several well known advantages such as :

- Specific to the dissolved oxygen, but the bounded oxygen, such as in oxide, is not taken into account;
- Rapid and continuous sensor, that is able to be implemented directly on the system, provided the leak tightness of the seal in between the liquid metal and the ceramic;
- Wide concentration range covered by one single sensor as well as its potential operating temperature range;
- No relation with the size and contact area of the electrodes.

In addition, the sensor makes hardly any disturbance on the measured system, and is in principle versatile, as it can be used on a number of applications.

However, its well-known limitation was its use at required operating temperature higher than 500-600°C, because of the high cell resistance that increases with decreasing temperature, as well as the irreversibility of the cell. In addition, the poor thermal shock resistance requires special care to prevent thermal cracking of the solid electrolyte. A specific protection from rapid temperature fluctuation shall be provided. Another solution is to design sensor as a consumable item. The service life is always reported as being in the range of the tens to hundreds of hours only.

Although the principle and the application are well known since the 50ies, especially at the laboratory scale for the measurement of basic thermodynamic data, its real application as industrial oxygen sensors began in the late 80ies where its applications covered lots of applications, from the automotive industries (Lambda sensors) to the glove box gas control. However, some particular and earlier application such as the sensor for the steel making industry, which is used to measure C/CO ratio, as well as the sensor for the liquid sodium to be used as nuclear coolant, could be noticed [Asher, 1988]. In addition, the Russian institutes developed a specific application for the oxygen control in Lead-bismuth eutectic to be used as coolant in nuclear submarines in the late 70ies-80ies [Gromov, 1997, 1998] [Shmatko, 2000], whose teams paved the ways for this very specific instrumentation in heavy liquid metal coolant with the use of very specific multi layers pellet type sensor. Since the mid-nineties, development and testing of new sensor design based on yttria stabilised zirconia or magnesia stabilised zirconia were conducted worldwide, including in Russia [Askhadulline, 2003, 2005] [Chernov, 2003] [Colominas, 2004] [Courouau, 2002b, 2004a] [Fernandez, 2002] [Ghetti, 2002] [Konys, 2001, 2004] [Li, 2003] [Muescher, 2001] [Zrodnikov, 2003] and [Takahashi, 2002].

 FPN FIS ING Sezione Ingegneria Sperimentale	DESCRIZIONE DI SISTEMI DI PURIFICAZIONE E CONTROLLO DELL'OSSIGENO PER SISTEMI A PISCINA	DOCUMENT AdP ENEA-MSE LP3-D	ISSUE DATE 16/02/2009	PAGE 17 of 51
		IT-G-T-001	Rev : 3	

The main requirements for an on-line oxygen sensor are as follows: accurate in such a low oxygen concentration range, reliable, predictable and safe for long-term nuclear operation. For instance, one of the main constraint as regards the safety for such system is related to the ceramic breakdown: any leaks of radioactive liquid metal outside the system must be prevented, as well as any ceramic pieces running in the nuclear loop. However, some limitations appeared on some sensors [Courouau, 2005b], such as the ceramic relative fragility, as well as the time drift that is often observed that will delay for a while their direct implementation on nuclear system. However, the Russian sensor design [Zrodnikov, 2003] was already used in the nuclear loop of the BOR-60 lead channel [Korotkov, 2003], which operated for about 100 days.

Principle

Sensors are based on the electromotive force (emf.) measurement method at null current for a galvanic cell built with a solid electrolyte: zirconia doped with either magnesia or yttria, as this doping element stabilizes the ceramic into the tetragonal form that is oxygen ions conducting for a certain temperature and oxygen conditions. Although the Russian feedback indicated the achievement of such sensors for the low operating conditions expected of the lead alloys [Gromov, 1997] [Shmatko, 2000], their assembly was not straightforward at first as it was considered that such electrodes and cells would not work for low temperature (<600°C), because of the irreversibility of the electrode, and because of the too high cell resistance.

 Sezione Ingegneria Sperimentale	DESCRIZIONE DI SISTEMI DI PURIFICAZIONE E CONTROLLO DELL'OSSIGENO PER SISTEMI A PISCINA	DOCUMENT AdP ENEA-MSE LP3-D	ISSUE DATE 16/02/2009	PAGE
		IT-G-T-001	Rev : 3	18 of 51

The electrodes define either the liquid metal phase where the dissolved oxygen is to be measured, the working electrode, as well as the reference electrode, which is the constant oxygen potential system, as illustrated in Fig.

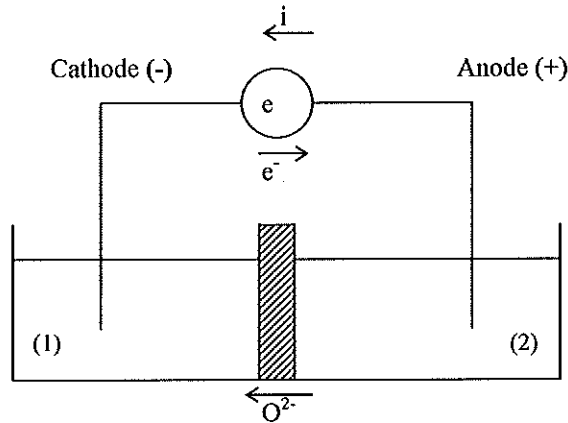

Figure. Galvanic cell principle.

Sensors assembly is made within the laboratory and is now considered as a routine procedure, as illustrated in Fig.4.4.2. The solid electrolyte is supplied by FRIATEC AG company (yttria doped zirconia, FzY grade, 8.1% in yttria) was used by [Courouau, 2003b] and [Konys, 2001] for instance whereas FERROTROM company supplied the ceramic used by IQS (both magnesia and yttria stabilized zirconia) [Colominas, 2004]. While some other suppliers can be found worldwide [Li, 2003], on-purpose ceramic can be synthesised and fired with the required characteristics and shape [Askhadulline, 2005].

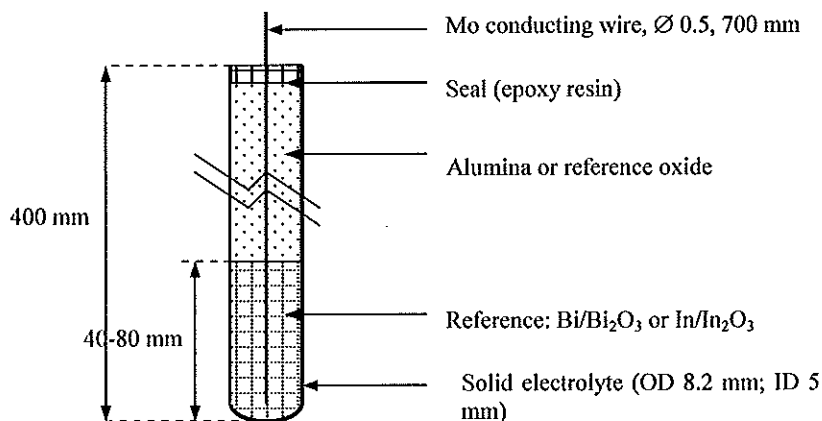



Figure Ceramic assembly principle [Courouau, 2002].

 FPN FIS ING Sezione Ingegneria Sperimentale	DESCRIZIONE DI SISTEMI DI PURIFICAZIONE E CONTROLLO DELL'OSSIGENO PER SISTEMI A PISCINA	DOCUMENT AdP ENEA-MSE LP3-D	ISSUE DATE 16/02/2009	PAGE
		IT-G-T-001	Rev : 3	19 of 51

Assembly is done in the open air. Ingots of pure metal and oxides powder are mixed to get a liquid metal internal reference at the operating temperature with only a slight excess of its oxide. 10% to 50% of oxide are reported as satisfactorily [Courouau, 2003a]. The air in excess is consumed during the first use, corresponding to the activation, to form oxide of the reference metal. The activation of the sensor is done during the calibration procedure or during its first use, the first step of which is the immersion of the sensor in a LBE melt followed by a temperature increase. Once the sensor is giving a stable emf. output, the reference is considered at the thermodynamic equilibrium, and the sensor is said activated. This is done in a matter of minutes at 450°C – 500°C.

The choice of the reference system depends widely on various parameters, such as for instance the gas or liquid phase, liquid metal are known to provide a better contact with the solid electrolyte, and then a lower cell resistance at comparatively lower temperature. The use of low melting point metal allows favour the use of the sensor in a higher temperature range. In addition, the contact lead wire must be compatible with the liquid metal melt of the reference. For instance, molybdenum presents a low solubility in bismuth, which is favourable. To the opposite, platinum or iridium metal, which are the typical lead wired for such electrochemical cell, dissolve in liquid bismuth, forbidding their use. The chemical compatibility with the solid electrolyte must be correct as well. These considerations explain why the choice for the reference systems focused firstly on the bismuth and indium systems.

The reference systems that were implemented and tested are:

- Bi/Bi₂O₃ (mp. 271°C), Mo lead wire ;
- In/In₂O₃ (mp.157°C), Mo lead wire;
- Air, Pt lead wire;

Several tens of sensors have been built up to now.

Theory

This analysis is done for pure lead as well as for the lead-bismuth (55% in weight) eutectic.

The method of the electromotive force (e.m.f.) measurement with null current can be applied to the measurement of the dissolved oxygen in liquid lead-bismuth alloys. A typical electrochemical galvanic cell, that will be subsequently referred to as EC sensor, is as follows:

Mo, Metal + metal oxide (reference) // ZrO₂ + Y₂O₃ // Pb + PbO (lead alloys solution), steel

where the yttria stabilized zirconia (YSZ) ceramic, which conducts specifically oxygen ions, separates 2 medias showing different oxygen activities : an electromotive force is then formed across the solid electrolyte. If one of the media is defined to act as a reference, so as to maintain constant the oxygen partial pressure to a defined value, then the e.m.f. is a function of the oxygen activity in the other medium.

 FPN FIS ING Sezione Ingegneria Sperimentale	DESCRIZIONE DI SISTEMI DI PURIFICAZIONE E CONTROLLO DELL'OSSIGENO PER SISTEMI A PISCINA	DOCUMENT AdP ENEA-MSE LP3-D	ISSUE DATE 16/02/2009	PAGE 20 of 51
		IT-G-T-001	Rev : 3	

Assuming pure ionic conduction in the solid electrolyte, and assuming that all transfers at the various interfaces developed in the electrochemical cell are reversible, the Nernst relation giving the theoretical e.m.f. can be written :

$$E_{th} = \frac{RT}{4F} \cdot \ln \frac{P_{O_2(reference)}}{P_{O_2}} \quad (4.23)$$

with E_{th} in Volts, R the perfect gas constant (8.31441 J/mol/K), F the Faraday constant (96484.6 C/mol), T the temperature (Kelvin), P_{O_2} the oxygen partial pressure in the media.

The oxygen partial pressure of the reference, is defined by the following reaction, in case of a metal (M) / metal oxide (M_xO_y) reference, where x and y are respectively the stoichiometric coefficients for the metal and the oxygen.



All reactions are written so that it corresponds to the consumption of one mole of oxygen. The units of the free enthalpies of formation are then expressed in J/mol of oxygen O_2 .

As the reference is built so as to present a constant oxygen partial pressure, both the metal and its oxide are present in excess to ensure the thermodynamic equilibrium of the reaction. In addition, the liquid solution corresponds to the pure metal, so that the activities of both the reference and its oxide are equals to one. The activities products of the oxide reaction of formation in lead alloys is then as follows:

$$\ln P_{O_2 reference} = \frac{\Delta_r G^0_{reference}}{RT} \quad (4.25)$$

The oxygen partial pressure in the lead alloy melt, is given by the thermodynamic equilibrium of lead monoxide, considering that it is the most stable oxide in lead bismuth eutectic.



The activities products of the lead oxide reaction of formation in lead alloys is then as follows using the oxygen activity defined in Eq. 4.7

$$\Delta_r G^0_{PbO} = -RT \cdot \ln \frac{a_{PbO}^2}{a_{Pb}^2 \cdot P_{O_2}} \quad \text{and then} \quad \ln P_{O_2} = \frac{\Delta_r G^0_{PbO}}{RT} + 2 \cdot \ln \frac{a_O}{a_{Pb}} \quad (4.27)$$

The saturated oxygen concentration for lead and LBE are derived from Eq. 4.12 and Eq. 4.13:

 FPN FIS ING Sezione Ingegneria Sperimentale	DESCRIZIONE DI SISTEMI DI PURIFICAZIONE E CONTROLLO DELL'OSSIGENO PER SISTEMI A PISCINA	DOCUMENT AdP ENEA-MSE LP3-D	ISSUE DATE 16/02/2009	PAGE 21 of 51
		IT-G-T-001	Rev : 3	

$$\text{Lead: } \ln C_{o(\text{wgt}\%)}^* = A - \frac{B}{T_{(K)}} \quad \text{with } A = 7.3683 \text{ and } B = 11512.925 \quad (4.28)$$

$$\text{LBE: } \ln C_{o(\text{wgt}\%)}^* = A' - \frac{B'}{T_{(K)}} \quad \text{with } A' = 2.7631 \text{ and } B' = 7828.789 \quad (4.29)$$

Lead activity is equal to unity in pure lead solution, and is given by the following Russian relation in LBE solution reported in [Courouau, 2002b]:

$$\text{LBE: } \ln a_{Pb} = -0.8598 - \frac{135.21}{T_{(K)}} \quad \text{or } \ln a_{Pb} = -\alpha - \frac{\beta}{T_{(K)}} \quad (4.30)$$

The free enthalpies of formation for the various oxides are expressed by the following relations, assuming that all relations are given for the consumption of one mole of O₂ :

$$\Delta G_{(J/mol)}^o = \Delta H^o - \Delta S^o \cdot T_{(K)} \quad (4.31)$$

Calculations are made with the help of the HSC database software (version 4.1), which represents a compilation of some of the latest thermodynamic data available. The free energies of formation are linearly regressed on a limited temperature range, 400-1000K, so as to determine the standards enthalpy and entropy by the least mean squares method. The latter data, standard enthalpy and entropy, are constant over the temperature range.

Main oxides free enthalpies coefficients for the 400-1000 Kelvin temperature range per mole of oxygen O₂ consumed.

$\Delta G_{(J/mol)}^o = \Delta H^o - \Delta S^o \cdot T_{(K)}$	ΔH^o (400-1000K) J/mol	ΔS^o (400-1000K) J/mol/K
4/3 Bi + O ₂ = 2/3 Bi ₂ O ₃	-389140	-192.6
2 Pb + O ₂ = 2 PbO	-437608	-199.1
4/3 In + O ₂ = 2/3 In ₂ O ₃	-618674	-216.8

The general relationship for a metal-metal oxide reference could then be derived from the Nernst relation, assuming a pure ionic conduction in the solid electrolyte:

$$E_{th} = \frac{\Delta G_{reference}^o - \Delta G_{PbO}^o}{4F} - \frac{RT}{2F} \ln \frac{a_O}{a_{Pb}} \quad (4.32)$$

 FPN FIS ING Sezione Ingegneria Sperimentale	DESCRIZIONE DI SISTEMI DI PURIFICAZIONE E CONTROLLO DELL'OSSIGENO PER SISTEMI A PISCINA	DOCUMENT AdP ENEA-MSE LP3-D	ISSUE DATE 16/02/2009	PAGE
		IT-G-T-001	Rev : 3	22 of 51

By using the following constants:

$$a = \frac{\Delta H_{reference}^{\circ} - \Delta H_{PbO}^{\circ}}{4F} \quad (4.33)$$

$$b = -\frac{(\Delta S_{reference}^{\circ} - \Delta S_{PbO}^{\circ})}{4F} \quad (4.34)$$

$$c = -\frac{R}{2F} \quad (4.35)$$

These constants allow to writing down simplified relations:

$$\text{(Lead)} \quad E_{th(V)} = a + b \cdot T_{(K)} + c \cdot T_{(K)} \cdot \ln a_o \quad (4.36)$$

$$\text{(LBE)} \quad E_{th(V)} = (a + c\beta) + (b + c\alpha) \cdot T_{(K)} + c \cdot T_{(K)} \cdot \ln a_o \quad (4.37)$$

Hence for saturated oxygen solution, the previous relations are only depending on the temperature:

$$\text{(Lead)} \quad E_{th(V)}^{SAT} = a + b \cdot T_{(K)} \quad (4.38)$$

$$\text{(LBE)} \quad E_{th(V)}^{SAT} = (a + c\beta) + (b + c\alpha) \cdot T_{(K)} \quad (4.39)$$

Finally, these general relations could be simplified by using the (a,b,c) constants and the concentration expressed in weight percent :

$$\text{(Lead)} \quad E_{th(V)} = (a + cB) + (b - cA) \cdot T_{(K)} + c \cdot T_{(K)} \cdot \ln C_{o(wgt\%)} \quad (4.40)$$

$$\text{(LBE)} \quad E_{th(V)} = (a + c\beta + cB') + (b + c\alpha - cA') \cdot T_{(K)} + c \cdot T_{(K)} \cdot \ln C_{o(wgt\%)} \quad (4.41)$$

The free energies are in good agreement with the respective energies computed with the use of other databases: JANAF, BARIN 1989; or even the Oxide Handbook, 1982. The slight inaccuracy of these data will affect the theoretical electromotive force calculation by a few millivolts that are assumed as reasonable. Another source of scattering is due to the data coming from the lead activity relation in LBE, which affect only slightly the emf. by a maximum of 10 mV, as well as from the oxygen solubility relation, which can affects, on the contrary, the emf. to a much greater extent. This is why it is essential to know with a relatively high accuracy the oxygen solubility data. However, there is only one available relation for LBE, known as the Orlov relation, whose accuracy and measurement method are not very well known.

 FPN FIS ING Sezione Ingegneria Sperimentale	DESCRIZIONE DI SISTEMI DI PURIFICAZIONE E CONTROLLO DELL'OSSIGENO PER SISTEMI A PISCINA	DOCUMENT AdP ENEA-MSE LP3-D	ISSUE DATE 16/02/2009	PAGE 23 of 51
		IT-G-T-001	Rev : 3	

The constants of the Nernst relations can then be calculated, and are reported in the next table for Bi/Bi₂O₃ and In/In₂O₃ reference electrodes for a cell immersed into a lead alloy melt according to the following emf. (E) vs. temperature (T) and oxygen concentration (C_o) relationships:

$$E_{(mV)} = K_1 + K_2 \cdot T_{(K)} + K_3 \cdot T_{(K)} \cdot \ln C_{o(ppm\ weight)} \quad \text{for } E > E_{sat} \quad (4.42)$$

$$E^{SAT}_{(mV)} = K + K' \cdot T_{(K)} \quad \text{for } E = E_{sat} \quad (4.43)$$

These relations enables to plot the E vs. T (C_o as parameter) diagram, which are most useful for reading sensor output as well as for calibration of sensor [Konys, 2001] [Gromov, 1998].

Apart from the data used for the theoretical assessment, there may be other causes for the sensor not to behave according to the theoretical relations: the electrolyte conduction properties (slight electronic conduction, impurities in the ceramic, etc.), the influence of the reaction at the electrode/electrolyte interface (liquid metal/zirconia reaction, or even traces of impurities depositing on the interface), the cell irreversibility (equilibrium not reached due to an oxygen transfer rate limitation especially at very low oxygen partial pressure), as well as the instrumental uncertainties. This is why calibration methods are often required [Subbarao, 1980] [Courouau, 2003b].

The following table synthesises the most useful relations for In and Bi reference sensor in LBE melts.

Theoretical relations for Bi/Bi₂O₃ and In/In₂O₃ references for LBE melts (E in mV, P in bar, T in kelvin, C in ppm (10⁻⁶ g/g)).

LBE	Bi/Bi ₂ O ₃ reference (melting point 271 °C)	In/In ₂ O ₃ reference (melting point 157 °C)
E _{sat} (T)	$E^{SAT}_{(mV)} = 119.8 - 0.0539 \cdot T$	$E^{SAT}_{(mV)} = -475 + 0.0088 \cdot T$
E(T, a _o), E > E _{sat}	$E_{(mV)} = 119.8 - 0.0539 \cdot T - 0.0431 \cdot T \cdot \ln a_o$	$E_{(mV)} = -475 + 0.0088 \cdot T - 0.0431 \cdot T \cdot \ln a_o$
E(T, C _o), E > E _{sat}	$E_{(mV)} = -218 + 0.0652 \cdot T - 0.0431 \cdot T \cdot \ln C_{o(wgt\%)}$ $E_{(mV)} = -218 + 0.462 \cdot T - 0.0431 \cdot T \cdot \ln C_{o(ppm)}$	$E_{(mV)} = -812 + 0.1279 \cdot T - 0.0431 \cdot T \cdot \ln C_{o(wgt\%)}$ $E_{(mV)} = -812 + 0.525 \cdot T - 0.0431 \cdot T \cdot \ln C_{o(ppm)}$
Ln a _o (T,E) E > E _{sat}	$\ln a_o = -23209 \cdot \frac{E_{(mV)}}{T} + \frac{2780}{T} - 1.251$	$\ln a_o = -23.209 \cdot \frac{E_{(mV)}}{T} - \frac{11024}{T} + 0.205$
Ln C _o (T,E) E > E _{sat}	$\ln C_{o(wgt\%)} = -23.21 \cdot \frac{E_{(mV)}}{T} - \frac{5049}{T} + 1.512$ $\ln C_{o(ppm)} = -23.21 \cdot \frac{E_{(mV)}}{T} - \frac{5049}{T} + 10.723$	$\ln C_{o(wgt\%)} = -23.21 \cdot \frac{E_{(mV)}}{T} - \frac{18853}{T} + 2.968$ $\ln C_{o(ppm)} = -23.21 \cdot \frac{E_{(mV)}}{T} - \frac{18853}{T} + 12.178$

 FPN FIS ING	DESCRIZIONE DI SISTEMI DI PURIFICAZIONE E CONTROLLO DELL'OSSIGENO PER SISTEMI A PISCINA	DOCUMENT	ISSUE DATE	PAGE
		AdP ENEA-MSE LP3-D	16/02/2009	
Sezione Ingegneria Sperimentale		IT-G-T-001	Rev : 3	24 of 51

Ln P _{sat} (T), E = E _{sat}	$\ln P_{O_2}^{SAT} = -\frac{52362}{T} + 25.67$	
Ln P (T,E) E = E _{sat}	$\ln P_{O_2} = -\frac{46803}{T} - 46.418 \frac{E}{T} + 23.16$	$\ln P_{O_2} = -\frac{74413}{T} - 46.418 \frac{E}{T} + 26.075$

Using another kind of reference sensor, the air/ platinum reference sensor, described as follows, similar relations could be derived:

$$\text{Pt, O}_2 \text{ (reference) // ZrO}_2 + \text{Y}_2\text{O}_3 \text{ // Pb + PbO (lead alloys solution), steel} \quad (4.44)$$

$$\text{(Lead)} \quad E_{th}^{SAT} (V) = \left(\frac{-\Delta H_{PbO}^{\circ}}{4F} \right) + \left(\frac{\Delta S_{PbO}^{\circ}}{4F} - \frac{c}{2} \cdot \ln 0.21 \right) \cdot T_{(K)} \quad (4.45)$$

$$\text{(Lead)} \quad E_{th} (V) = \left(\frac{-\Delta H_{PbO}^{\circ}}{4F} + cB \right) + \left(\frac{\Delta S_{PbO}^{\circ}}{4F} - \frac{c}{2} \cdot \ln 0.21 - cA \right) \cdot T_{(K)} + c \cdot T_{(K)} \cdot \ln C_{o(wgt\%)} \quad (4.46)$$

$$\text{(LBE)} \quad E_{th}^{SAT} (V) = \left(\frac{-\Delta H_{PbO}^{\circ}}{4F} + c\beta \right) + \left(\frac{\Delta S_{PbO}^{\circ}}{4F} - \frac{c}{2} \cdot \ln 0.21 + c\alpha \right) \cdot T_{(K)} \quad (4.47)$$

$$\text{(LBE)} \quad E_{th} (V) = \left(\frac{-\Delta H_{PbO}^{\circ}}{4F} + cB' + c\beta \right) + \left(\frac{\Delta S_{PbO}^{\circ}}{4F} - \frac{c}{2} \cdot \ln 0.21 - cA' + c\alpha \right) \cdot T_{(K)} + c \cdot T_{(K)} \cdot \ln C_{o(wgt\%)} \quad (4.48)$$

Finally, these relations are calculated for the saturation using the data previously given using the oxygen concentration expressed in ppm (10^{-6} g/g):

$$\text{(Lead)} \quad E_{(mV)}^{SAT} = 1133.9 - 0.550 \cdot T_{(K)} \quad (4.49)$$

$$\text{(Lead)} \quad E_{(mV)} = 637.8 + 0.165 \cdot T_{(K)} - 0.043 \cdot T_{(K)} \cdot \ln C_{o(ppm)} \quad \text{for } E > E_{sat} \quad (4.50)$$

$$\text{(LBE)} \quad E_{(mV)}^{SAT} = 1128.1 - 0.587 \cdot T_{(K)} \quad (4.51)$$

$$\text{(LBE)} \quad E_{(mV)} = 790.7 - 0.071 \cdot T_{(K)} - 0.043 \cdot T_{(K)} \cdot \ln C_{o(ppm)} \quad \text{for } E > E_{sat} \quad (4.52)$$

 FPN FIS ING Sezione Ingegneria Sperimentale	DESCRIZIONE DI SISTEMI DI PURIFICAZIONE E CONTROLLO DELL'OSSIGENO PER SISTEMI A PISCINA	DOCUMENT	ISSUE DATE 16/02/2009	PAGE
		AdP ENEA-MSE LP3-D		
		IT-G-T-001	Rev : 3	25 of 51

Calibration

Several calibration methods were developed in static conditions such as:

- The temperature variation close to the oxygen saturation [Konys, 2001] [Courouau, 2002b], as illustrated in the following figure, which allow defining accurately the oxygen content of a liquid melt, supposing its concentration stable during the measurement;
- The comparison against metal-metal oxide couple that buffer the oxygen concentration to the equilibrium level [Colominas, 2004];
- The comparison to the known gas phase oxygen content such as the steam/hydrogen gaseous mixture [Konys, 2004] that define in principle the oxygen concentration in the liquid bulk as illustrated in Fig. 4.4.4;
- The comparison with the actual dissolved oxygen added to the solution measured and introduced by a specific electrochemical pump [Ghetta, 2002]

These methods concluded to a rather good agreement between the sensor voltage output and the theoretical emf., and usually justified the use of the theoretical emf. relation for the calculation or the oxygen concentration.

However, a slight scatter of a few millivolts, up to several tens of millivolts is always observed from this theoretical behaviour that is not fully understood yet. The effect of the other impurities might be the source of the errors, by reacting at the solid electrolyte interface and forming metal/metal oxide couple interfering with the electrode potential. This would have to be understood more clearly as this side effect on the calibration process may limit the reliability of the sensors. The second source of errors is interpreted as coming from the zirconia intrinsic properties: slight impurities variations in the fabrication process may be the explanation [Subbarao,1980] [Courouau, 2004a].

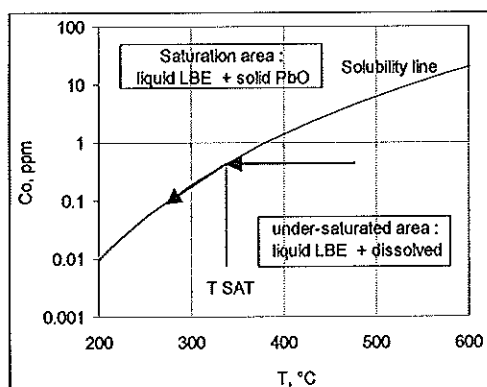



Figure. Oxygen in LBE concentration –temperature diagram illustrating the principle of the calibration by the variation of temperature close to the saturation [Courouau, 2003b], in specific operating conditions where the concentration remains constant, allowing to assess K_1 , K_2 , K and K' , assuming K_3 constant.

 Sezione Ingegneria Sperimentale	DESCRIZIONE DI SISTEMI DI PURIFICAZIONE E CONTROLLO DELL'OSSIGENO PER SISTEMI A PISCINA	DOCUMENT	ISSUE DATE	PAGE
		AdP ENEA-MSE LP3-D	16/02/2009	
		IT-G-T-001	Rev : 3	26 of 51

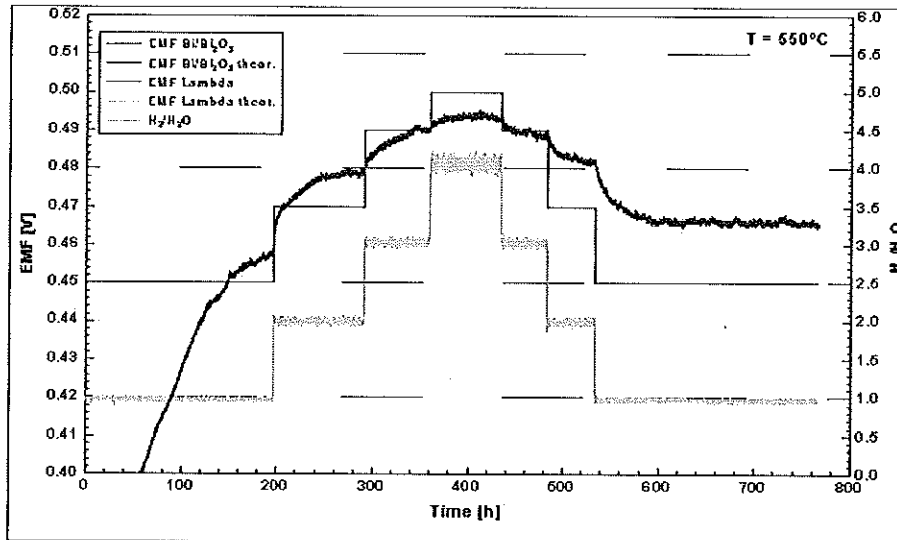

Figure Comparison between the numerical EMF(τ) prediction for a gaseous steam/hydrogen control and the sets of experimental data for the Bi/Bi₂O₃ system (KOSIMA-AT, FZK) [Konys, 2004]

The temperature variation close to the oxygen saturation calibration method was repeated a large number of times so that mean statistical constants could be derived from it, and are then recommended instead of the use of the theoretical constants [Courouau, 2003b]:

$$Bi / Bi_2O_3 \begin{cases} E^{SAT} (mV) = 137 - 0.067 \cdot T_{(K)} \\ E_{(mV)} = -323 + 0.23 \cdot T - 0.0431 \cdot T \cdot \ln C_{o(ppm)} \end{cases} \quad (4.53)$$

$$In / In_2O_3 \begin{cases} E^{SAT} (mV) = -412 - 0.051 \cdot T_{(K)} \\ E_{(mV)} = -937 + 0.71 \cdot T - 0.0431 \cdot T \cdot \ln C_{o(ppm)} \end{cases} \quad (4.54)$$

The accuracy is assessed within 5% of the voltage readings (25 mV maximum scattering for a 500 mV reading) that affect the concentration by 40% for the high concentration range to 80% for the low concentration range. Calibration is, in any case, recommended to achieve a better accuracy. However, the availability of a method to achieve a calibration on the field would be most useful to significantly increase the accuracy on the long term, as well as to regularly assess the good operation of the sensor.

This could be particularly critical as the time drift that was observed on several occasions on static device was recently confirmed by the STELLA loop operation. Several hypotheses could be proposed to explain this deviation with time [Courouau, 2005b]: alteration of the interface of the electrode (working or reference) by oxide deposition, reaction with the LBE or the liquid metal reference, or alteration on the long term of the solid electrolyte interface by reaction with liquid metals, gases or even oxides. Basic investigation on broken sensor gave no clear results up to now as regards the Molybdenum lead wire, which could thermodynamically be oxidized by the liquid bismuth

 FPN FIS ING Sezione Ingegneria Sperimentale	DESCRIZIONE DI SISTEMI DI PURIFICAZIONE E CONTROLLO DELL'OSSIGENO PER SISTEMI A PISCINA	DOCUMENT AdP ENEA-MSE LP3-D	ISSUE DATE 16/02/2009	PAGE 27 of 51
		IT-G-T-001	Rev : 3	

of the reference electrode, as the relative stability of the potential oxide is as follows: $\text{In}_2\text{O}_3 > \text{MoO}_2$, $\text{MoO}_3 > \text{Bi}_2\text{O}_3$ [Li, 2004].

In any case, this procedure and results have to be compared to other procedure and calibration results to better assess the accuracy of the calibration procedure as well as to understand the potential side effects, and eventually to validate on-the-field calibration standards that would greatly enhance the overall sensor reliability.

Figure STELLA time drift observation for the Bi/Bi₂O₃ and In/In₂O₃ sensors, T_{respom} being the isothermal temperature of the loop, and SO₂ the gas phase sensor signal (Zirox).

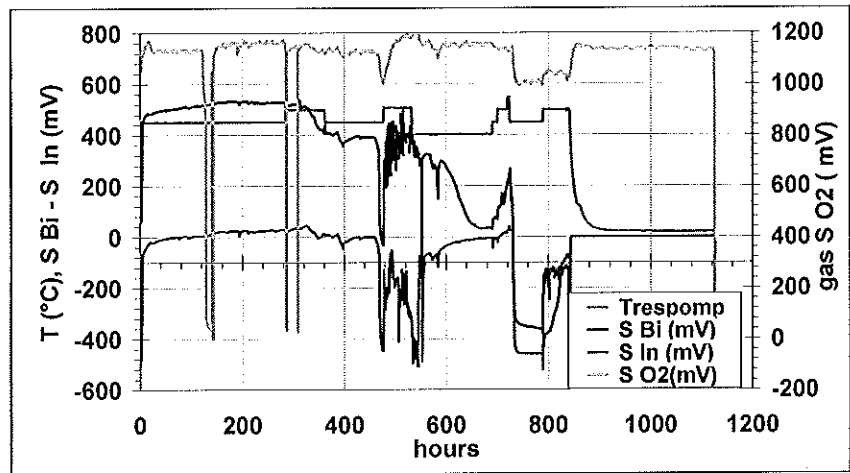

Characteristics of the oxygen sensors

Sensors have been tested for thousands of hours in both static and dynamic conditions in stable and unstable chemical conditions that validate their effective and reliable use for dynamic loop operation [Askhadulline, 2005] [Ghetta, 2002] [Colominas, 2004] [Courouau, 2003b] [Gromov, 1997] [Konys, 2004] [Shmatko, 2000]. These tests allowed gaining a large operating feedback representative of long-term operations on a wide variety of operating conditions. The characteristics observed up to now on these oxygen prototypes sensors are then satisfactorily and confirm the previous observations, as regards the operating range (370°C - 550°C), the oxygen concentration range, the response time, the accuracy and reproducibility, as well as the service life (up to 4000 hours observed in stable conditions, and longer expected). A Lower operating temperature than 350°C is possible but with a lower accuracy as the sensor outputs deviate from ideal behaviour most probably because of an increasing irreversibility of the cell.

The time to react to a concentration change is fast for oxygen pollution. The recovery time is linked to the chemical reaction kinetics that is limited by the mass transfer phenomenon (gas liquid interface, oxygen diffusion in liquid bulk...). From a general point of view, the transient phase of one system is not absolutely reliable as the oxygen content is globally inhomogeneous. However, this

ENEA FPN FIS ING Sezione Ingegneria Sperimentale	DESCRIZIONE DI SISTEMI DI PURIFICAZIONE E CONTROLLO DELL'OSSIGENO PER SISTEMI A PISCINA	DOCUMENT AdP ENEA-MSE LP3-D	ISSUE DATE 16/02/2009	PAGE
		IT-G-T-001	Rev : 3	28 of 51

effect disappears in steady state conditions. The sensor gives only the local oxygen content, so that the loop implementation is important to get reliable information of a homogenous system [Orlov, 2005].

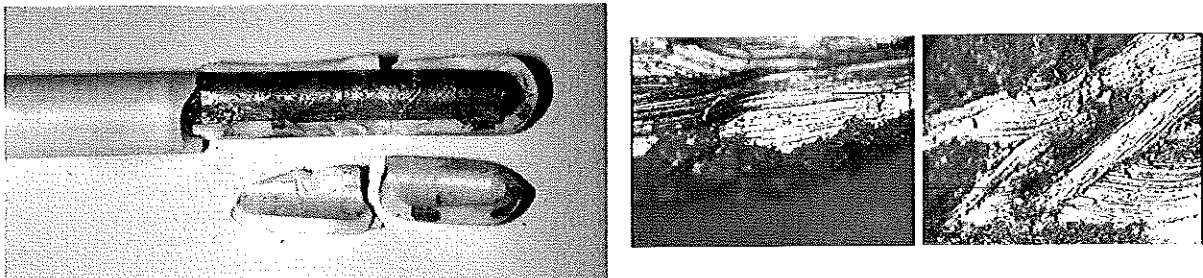



Figure. Bi/Bi₂O₃ sensor operated for 1400 hours on the STELLA loop and details of the point of rupture [Courouau, 2005b].

The time drift is negligible with low oxygen concentration and stable operating conditions. High oxygen content, or oxygen cycling, seems to affect the sensor output, reducing its service life. The other impurities present in the liquid metal may play a role as well. Another explanation is related to the electrolyte limitation itself. This could be solved by a cleaning operation (high temperature in low oxygen content, or, to be tested, a nitric acid washing of the zirconia). This is a point to be further studied, as this would possibly require a calibration procedure suited for loop operation, an on-the-field procedure, that is not available yet, as well as a specific and complex regeneration procedure.

Although the yttria doped zirconia is known to present a better thermal shock resistance (temperature gradient, temperature cycling) as well as a better mechanical resistance when hot (vibrations, contact, etc.) when compared to other solid electrolytes such as the yttria stabilized thoria, a number of failure has been observed (Fig.). The point of breakdown is often observed at the central point localized at the bottom of the ceramic thimble. The internal reference is itself a source of mechanical constraint during its solidification during the sensor cooling. Optic observations of the ruptured ceramic surface (Fig.) indicate the gradual insertion of bismuth into micro cracks most probably due to the positive volumetric change of Bi during its solidification. Lowering the height of the internal reference will reduce this detrimental effect quite simply. However, a new technique for assembling the reference would be required. By comparison, the Air/Pt reference sensor [Konys, 2004] exhibited a much higher service lifetime when compared to the Bi/Bi₂O₃ reference sensor used within the same operating conditions.

Another method to increase the mechanical resistance of the ceramic and to reduce failures is to use a proper design for the ceramic housing, which has not been used up to now, together with the use of special procedure for operation. This was typically used for the liquid sodium sensor (Westinghouse, Harwell) and is known as efficient. Fig.4.4.7 presents the design for the housing that has been achieved, and that must be validated on the STELLA loop: its main characteristics consist in having the seal ensuring the tightness of the facility between the ceramic and the metallic structure localized in the cold area, which is made possible thanks to the ceramic length, and thanks to the copper fins. The ceramic is protected with a metallic sheath reducing shocks, both thermal and mechanical, and keeping ceramic pieces in case of rupture. This kind of design proved efficient in

 ENEA FPN FIS ING	DESCRIZIONE DI SISTEMI DI PURIFICAZIONE E CONTROLLO DELL'OSSIGENO PER SISTEMI A PISCINA	DOCUMENT	ISSUE DATE	PAGE
		AdP ENEA-MSE LP3-D	16/02/2009	
Sezione Ingegneria Sperimentale		IT-G-T-001	Rev : 3	29 of 51

liquid sodium technology, as the sensor service lifetime was not depending from the sealing medium, which, if localized in the bottom area, would be in contact with high temperature liquid metal.

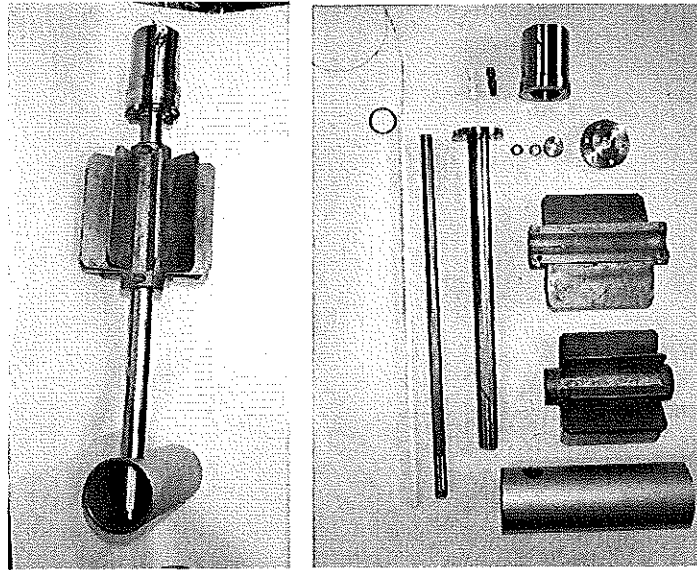
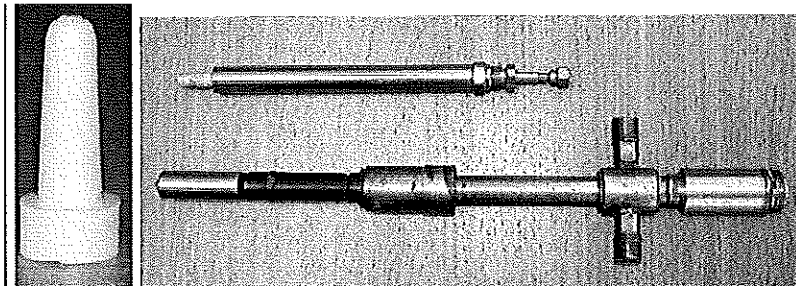

Figure. CEA Sensor housing to be tested on the STELLA loop [Courouau, 2005b].

Although the closed-end tube shape is commercially available and easily separates the 2 electrodes, the working and the reference electrodes, it might be replaced by other less fragile shapes, like a conical shape sealed [Li, 2003] or fused [Chernov, 2003] to a metallic tube that is reported as far more resistant. However, the implementation becomes more complex because of the issue of the metal-to-ceramic sealing and fusing, without speaking of the cost of the specific fabrication of ceramic pieces. The Russian model, dating from the early 90ies, and which is now registered in the Russian state standard committee, was, for instance, implemented on the BOR-60 lead channel and operated satisfactorily during the irradiation time [Korotkov, 2003]. The US model (Fig.), more recent, is awaiting long-term validation in representative conditions.

Figure. A schematic cross-sectional view of oxygen sensor developed by IPPE [Zrodnikov, 2003].



 FPN FIS ING	DESCRIZIONE DI SISTEMI DI PURIFICAZIONE E CONTROLLO DELL'OSSIGENO PER SISTEMI A PISCINA	DOCUMENT AdP ENEA-MSE LP3-D	ISSUE DATE 16/02/2009	PAGE
		IT-G-T-001	Rev : 3	30 of 51
Sezione Ingegneria Sperimentale				

Figure. LANL ceramic element with the graph-lock gasket and the metallic sheath with the seating ring [Li, 2003]



Different electrodes were tested. The use of the air/Pt reference proved efficient [Konys, 2004] and exceptionally stable with time, but the safety issue related to its implementation on a nuclear system is not solved: the potential contamination due to liquid spillage in case of ceramic breakdown requires a specific solution. The use of the Bi/Bi₂O₃ system appears more favourable from that particular point of view, as the cell could be made more resistant to prevent any liquid metal leaks in case of ceramic failure. In addition, the reference metal is part of the coolant composition, and is not a source of pollution in case of rupture. By contrast, the indium reference system leads to a slight pollution when broken, whereas its performances should be better for lower operating temperature, as the indium melting temperature is lower than that of the bismuth. In addition, the range of the outputs for this latter system can present a null voltage output, which doesn't mean that the sensor is broken. This represents clearly an operating difficulty, as, in that case, there is no straight possibility to conclude between the effectiveness or the failure of the sensor. An example of that behaviour was observed during STELLA operation (Fig.), where the In sensor was believed broken for several days, and several time when its output was close to the null value. This point discards this reference system for nuclear operation, unless systematic and standard calibration could be developed for a periodic checking of the sensor.

Conclusions

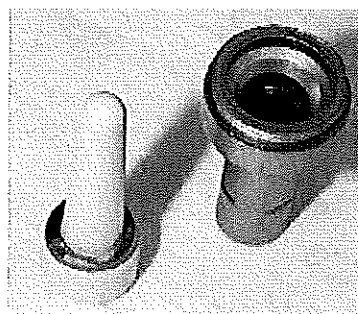
The oxygen sensors implementation on loop proved to be efficient and gave reliable information [Chernov, 2003] [Courouau, 2005]. Several level of achievement are can be noticed. Their uses, however, are still not straight forward, especially on dynamic loop facilities, as a number of limiting parameters could be encountered. This makes the device not fully reliable for a nuclear implementation. The open points requiring further investigations are related to the improvement of the sensor reliability for their nuclear use by:

- Calibration standards definition and on-the-field procedure;
- Sensor housing optimization for easiness, robustness and safety;
- Time drift understanding and recovery procedure development;

Some of the required studies are integrated in the European program for transmutation (IP-EUROTRANS), which is part of the 6th framework plan. It is presenting a close relation with the

 FPN FIS ING Sezione Ingegneria Sperimentale	DESCRIZIONE DI SISTEMI DI PURIFICAZIONE E CONTROLLO DELL'OSSIGENO PER SISTEMI A PISCINA	DOCUMENT AdP ENEA-MSE LP3-D	ISSUE DATE 16/02/2009	PAGE
		IT-G-T-001	Rev : 3	31 of 51

International science and technology centre project number n° 3020 involving the Institute of Physics and Power Engineering [Askhadulline, 2005].

CONCLUSIONS

The chemistry control in a nuclear system appears as a quite complex issue, and particularly critical to keep under control the corrosion in a wider operating temperature range, as well as to keep the coolant free of any contamination by oxides, which is basically the first requirement. The radiochemistry control appears as well as difficult, as, production rates are relatively inaccurate, and as the transport phenomena as well as associated purification processes are to be more understood and developed.

However, the chemistry control is usually not critical for operation if it was taken into account at the early stage of the design as well as during the start-up and shutdown procedures. This is why it should not be neglected in designing any kind of systems, especially in the view of the potential operating difficulties that could result from it. Well-designed and well-operated facilities could be run, in principle, with a rather high confidence, in the no-oxygen conditions. Higher operating temperatures require the validation of oxygen control systems at a specified medium range concentration on the long term for larger systems, and especially for pure lead.

There are some strong similarities in the chemistry analysis of water, liquid sodium and lead alloys systems. All systems presents quite identical requirement for both monitoring and processes. However, the consequences for a LBE system as much more critical, such as the loss of cooling capacity due to plugging or the loss of confinement due to corrosion, which makes this issue as one of the most important one when operating such system.

Some points remains for further studies, such as the process optimization of oxygen control systems, the improvement of the reliability of the associated instrumentation, such as the oxygen sensor, as well as the basic phenomena for aerosols, particles and mass transfer, even of impurities present in traces such as the radio-contaminants, within a close and tight system on the long term, for which the basic understanding should be increased.

THE ENEA EXPERIENCE IN LBE AND LEAD

 FPN FIS ING Sezione Ingegneria Sperimentale	DESCRIZIONE DI SISTEMI DI PURIFICAZIONE E CONTROLLO DELL'OSSIGENO PER SISTEMI A PISCINA	DOCUMENT AdP ENEA-MSE LP3-D	ISSUE DATE 16/02/2009	PAGE
		IT-G-T-001	Rev : 3	32 of 51

Several experimental facilities running with HLM are located at ENEA Brasimone research centre. Since the late 90's, many experiments involving electrochemical sensors for Pb and its alloys have been carried on. Oxygen sensors have been calibrated and run both in LBE and Pb.

Calibration experimental procedure

Oxygen Fine Measure experimental device

The OFM (Oxygen Fine Measure) calibration facility is a device built in order to test and improve electrochemical oxygen sensors for liquid metals in stagnant conditions. It consists of a cylindrical vessel, a heating system, an inert atmosphere gas bubbling system and an electronic multimeter.

The recorder registers the temperature of the vessel, the sensor signal and the gas pressure. The bubbling is performed with Ar coming from a pressured tank. The vessel has an interchangeable top with a swagelock sealing for the gas pipes and the sensor itself.

There are two kinds of vessel tops: a simple one for measures in reducing conditions and a more complex one for oxidizing conditions tests.

Test parameters

Two Bi/Bi₂O₃ reference oxygen sensors, made by IPPE, Obnisk, RU, were calibrated in the OFM facility, recording the EMF signal and their behaviour in different temperatures.

For simulating the CHEOPE III loop oxidizing conditions, i.e. an oxygen concentration of 10⁻⁵-10⁻⁶ wt %, solid Fe was added to the liquid Pb-55.5 Bi eutectic; for simulating the reducing LECOR environment, solid Mg was added and an oxygen concentration of 10⁻⁸ - 10⁻¹⁰ wt % was reached. The atmosphere was kept inert via an Ar bubbling inside the vessel.

The calibration process followed the scheme summarized in Table.

Step	Value
Temperature gradient	673K – 813K
Temperature step	20K
Gas inlet	Ar+H ₂ (3%)
Number of temperature tests	2
Total LBE volume	0.5 l
Vessel material	AISI 316L

Two temperature loops were performed in order to check the reputability of the electrode signals. The acquisition system for the CHEOPE III sensor was a digital one, while the one for the LECOR sensor signal was an analogical data recorder. This is why the EMF graphics are different and the calculation of a tendency line for the analogical graphics was necessary.

Calibration experimental results

 FPN FIS ING	DESCRIZIONE DI SISTEMI DI PURIFICAZIONE E CONTROLLO DELL'OSSIGENO PER SISTEMI A PISCINA	DOCUMENT	ISSUE DATE	PAGE
		AdP ENEA-MSE LP3-D	16/02/2009	
Sezione Ingegneria Sperimentale		IT-G-T-001	Rev : 3	33 of 51

After the calibration campaign, the data collected were plotted in order to compare the behaviour of the sensors in different environmental conditions.

They show a quite linear behaviour of the two sensors, in stagnant condition.

Errore. L'origine riferimento non è stata trovata. summarizes the experimental results, comparing them with the calculated theoretical curves of FEM at fixed oxygen concentration. The iron oxide curve and the magnesium oxide one are emphasized.

It is possible to underline the good behaviour of both the sensors at different temperature plotting the output EFM signal parallel to the temperature variations. **Errore. L'origine riferimento non è stata trovata.** shows the sensor signal of the LECOR and the CHEOPE III loops.

Theoretical FEM values: sensor calibration comparison

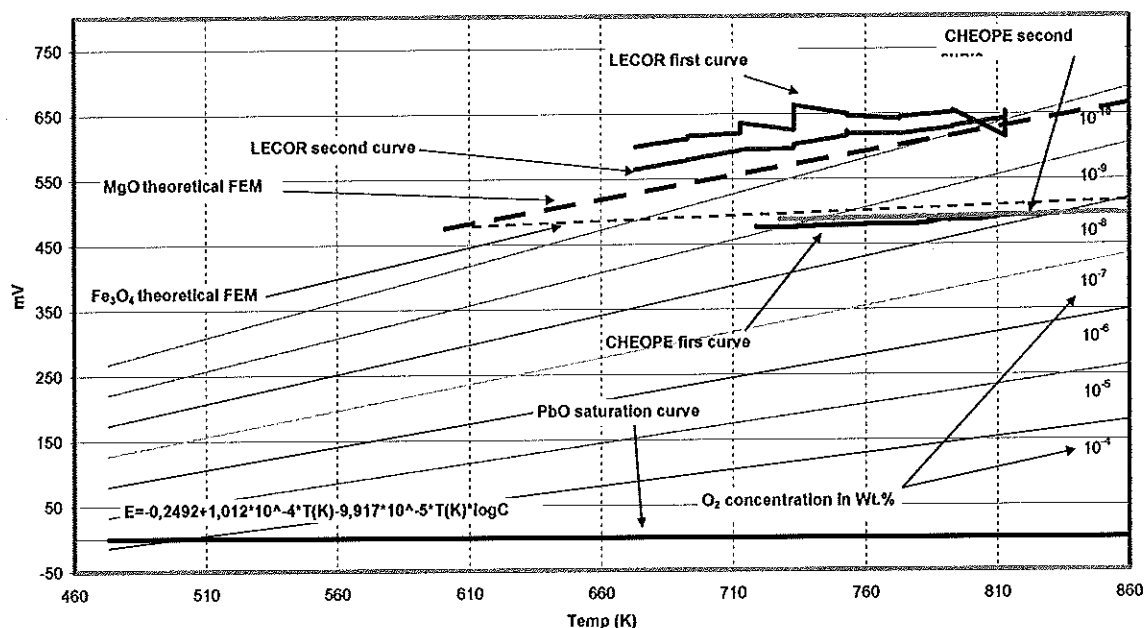

Calibration conclusions

Both Bi|Bi₂O₃ sensors gave good accordance between expected and experimental data, in stagnant conditions. The EMF measured values were consistent with the predicted calculated ones giving an accurate behaviour, with an excellent agreement with the calibration standard for further work.

During the calibration campaign in Lead, it has been noted that the outcome signal does not vary too much then the one in LBE. Usually it is, at least, 10 – 20nV less then the previous one for the same testing temperature.

Experimental Data

After the calibration procedure the sensors were mounted in the LECOR and CHOPE loops.

 Sezione Ingegneria Sperimentale	DESCRIZIONE DI SISTEMI DI PURIFICAZIONE E CONTROLLO DELL'OSSIGENO PER SISTEMI A PISCINA	DOCUMENT AdP ENEA-MSE LP3-D	ISSUE DATE 16/02/2009	PAGE 34 of 51
		IT-G-T-001	Rev : 3	

LECOR loop data

Bi|Bi₂O₃

The historical reconstruction of the oxygen sensor signal during the four experimental runs (T= 673 K, constant) is shown in **Errore. L'origine riferimento non è stata trovata.**

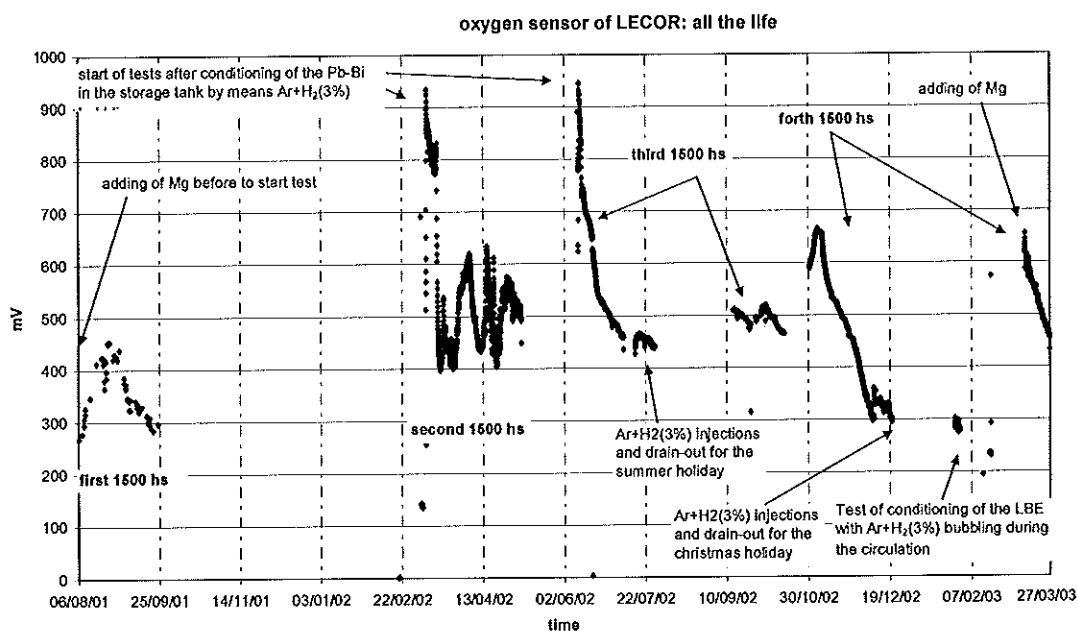

In the first run, before starting exposure tests, 130.8 g of Mg were added in 400 l ca. of LBE in order to guarantee the reducing conditions. In the second run, after the conditioning in the storage tank with Ar+H₂(3%), the oxygen signal stands near 500±100 mV. In the third run, shows an oscillatory path near 500±30 mV, even though there had been a plant stop. In the fourth run the oxygen concentration grew up consistently; for lowering this, a gas bubbling was performed, without success, and then Mg was added again.

It is noticeable how the oxygen concentration has an oscillating behaviour. This result has to be considered excellent, being these variations very small. In particular, after the LBE conditioning the sensor signal starts from very high mV values and later lowers towards the acceptable value of 500 mV ca, indicating slightly more reducing conditions than the minimal required signal (>350 mV).

ln|In₂O₃

After the first 1400h a historical reconstruction of its signal is possible. In **Errore. L'origine riferimento non è stata trovata.** it is clearly visible the reducing action performed in the first days in the storage tank. When the test campaign started the injection of Ar/H₂ was stopped. In the graph it is possible to see how the oxygen content slightly increase.

 FPN FIS ING Sezione Ingegneria Sperimentale	DESCRIZIONE DI SISTEMI DI PURIFICAZIONE E CONTROLLO DELL'OSSIGENO PER SISTEMI A PISCINA	DOCUMENT AdP ENEA-MSE LP3-D	ISSUE DATE 16/02/2009	PAGE
		IT-G-T-001	Rev : 3	35 of 51

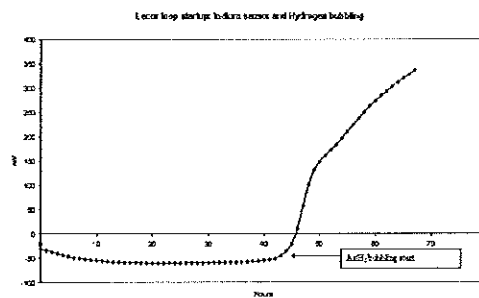
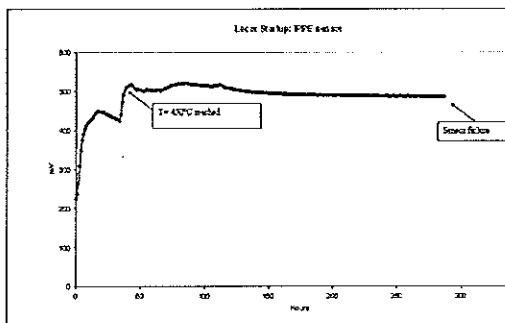
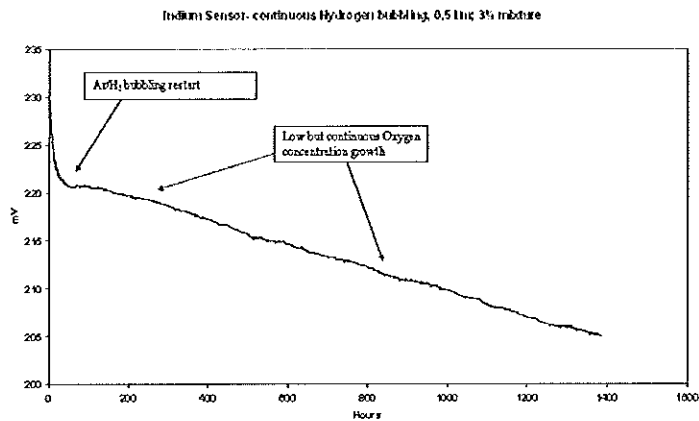

This is caused by the mass transfer between the passivated pipe walls and the reduced LBE.
 A comparison between the behaviour of the two different sensors is shown in **Errore. L'origine riferimento non è stata trovata.**

As it can be observed the output signal is in the first case positive and it grows up to a constant value (~ 500mV). Two slopes are clearly identified. They show two Ar+H₂ bubbling series. After the first one the O₂ content increased a little, while after the second one the oxygen content remains almost constant.

The second case the signal is negative and changes to positive values due to gas bubbling.

The two sensors, with a very good agreement, show that the H₂ bubbling method is effective in order to reduce the oxygen content.

CHEOPE III loop data

In the CEOPE III loop were performed 10000h of corrosion tests in Lead Bismuth. During the hole duration of the campaign the O₂ content was measured with a Bi|Bi₂O₃ sensor and recorded. After the conclusion of the tests the loop was emptied cleaned and re filled with pure Lead, in order to start another 10000h material compatibility test with a different liquid metal.

 FPN FIS ING Sezione Ingegneria Sperimentale	DESCRIZIONE DI SISTEMI DI PURIFICAZIONE E CONTROLLO DELL'OSSIGENO PER SISTEMI A PISCINA	DOCUMENT AdP ENEA-MSE LP3-D	ISSUE DATE 16/02/2009	PAGE
		IT-G-T-001	Rev : 3	36 of 51

Bi|Bi₂O₃ in LBE

The historical reconstruction of the oxygen sensor (Bi|Bi₂O₃) signal of CHEOPE III loop (T=673 K, constant) is shown in **Errore. L'origine riferimento non è stata trovata.**

The operation oxygen concentration range is 10⁻⁵-10⁻⁶ wt%, corresponding to a 150-200 mV signal ca. These conditions is very close to the saturation value for PbO (10⁻⁴ wt%, i.e. 76 mV ca.) and for this reason are very difficult to be exactly controlled. This could be seen comparing the two historical pictures of the two facilities: in the CHEOPE III one, plant stops and technical problems are much more frequent, where the following analyses of the impurities gave PbO as the main result. From this behaviour it is possible to infer that the sensor signal, even so near to the lead oxide saturation, is reliable.

The sensor response to the on line gas bubbling is not immediate. Some weeks are necessary to stabilize the signal, as depicted in **Errore. L'origine riferimento non è stata trovata.**, showing the sensor signal after one month while some bubbling were performed.

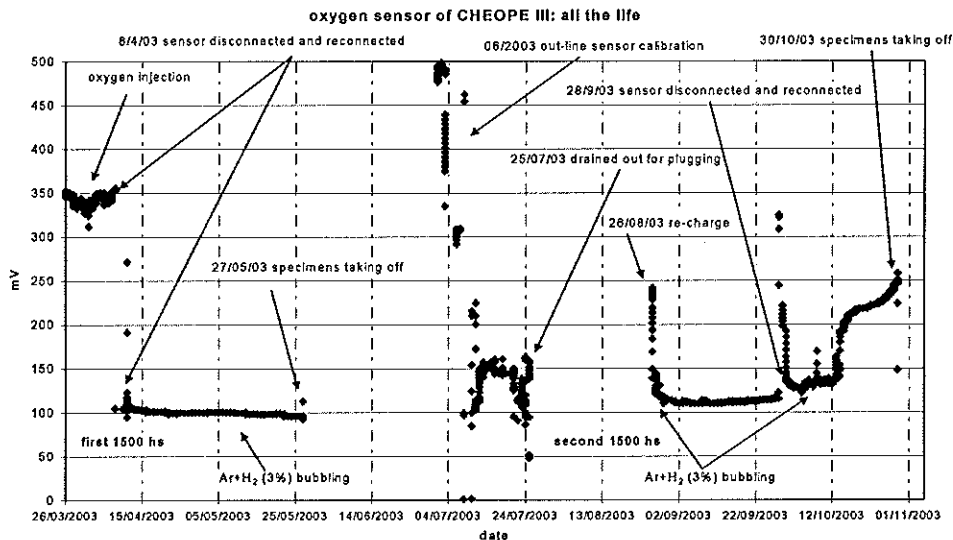

Figure

 FPN FIS ING	DESCRIZIONE DI SISTEMI DI PURIFICAZIONE E CONTROLLO DELL'OSSIGENO PER SISTEMI A PISCINA	DOCUMENT	ISSUE DATE	PAGE
		AdP ENEA-MSE LP3-D	16/02/2009	
Sezione Ingegneria Sperimentale		IT-G-T-001	Rev : 3	37 of 51

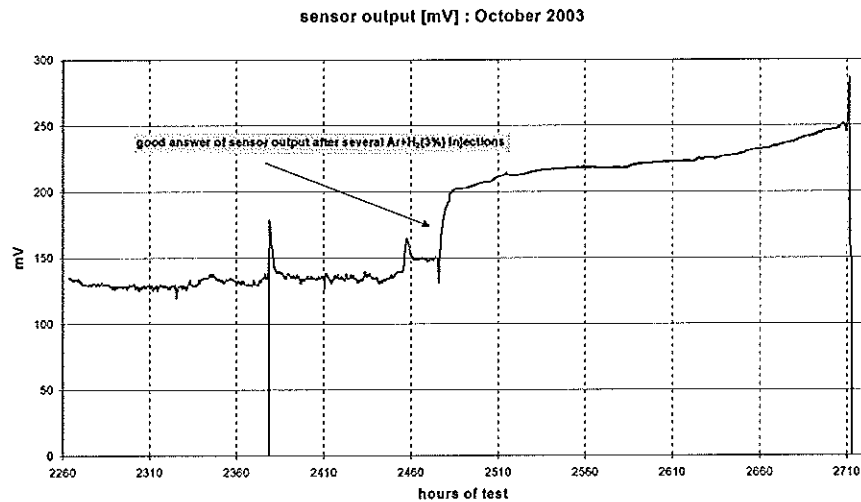

Figure

Bi|Bi₂O₃ in Lead

After the conclusion of the corrosion tests in LBE, in the frame of the 6th framework programme, the PbBi was substituted with pure Lead. This in order to perform new compatibility tests.

The Bi|Bi₂O₃ sensor installed in the plant was recalibrated and set in the third test section in order to monitor the content of the oxygen dissolved in the Lead, during the tests.

According to theory, a specific "working area" for this reference electrode can be summarized as in figure.

 Sezione Ingegneria Sperimentale	DESCRIZIONE DI SISTEMI DI PURIFICAZIONE E CONTROLLO DELL'OSSIGENO PER SISTEMI A PISCINA	DOCUMENT AdP ENEA-MSE LP3-D	ISSUE DATE 16/02/2009	PAGE
		IT-G-T-001	Rev : 3	38 of 51

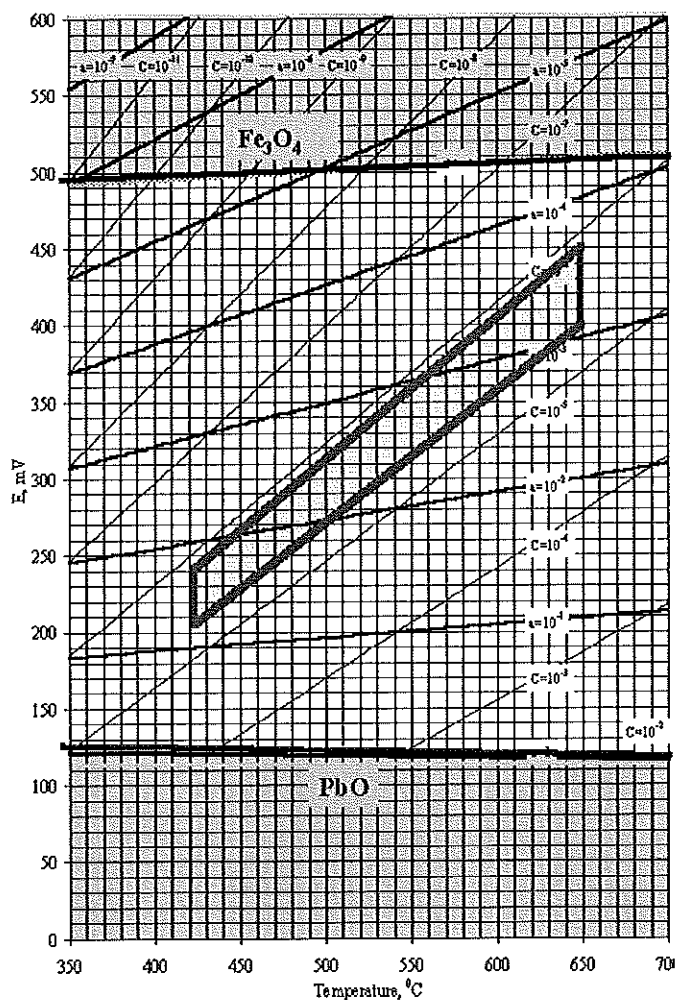

Where the reference equation for Bi_2O_3 sensor, $C_o < \text{saturation}$ is:

$$E_{(mV)} = -218 + 0.0652 \cdot T - 0.0431 \cdot T \cdot \ln C_{o(\text{wt}\%)}$$

[Kyrillov et al., 2005]

In Errore. L'origine riferimento non è stata trovata. the first 2000h are graphed. It is possible to see that during the first 500h the oxygen dissolved increased and how it decreased after the injection on Ar/H_2 . The gas mixture was bubbled for 10^5 minutes at a flow rate of 0,5 l/min. When the bubbling of the mixed gas was suspended the oxygen content increased.

ENEA FPN FIS ING Sezione Ingegneria Sperimentale	DESCRIZIONE DI SISTEMI DI PURIFICAZIONE E CONTROLLO DELL'OSSIGENO PER SISTEMI A PISCINA	DOCUMENT	ISSUE DATE	PAGE
		AdP ENEA-MSE LP3-D	16/02/2009	
		IT-G-T-001	Rev : 3	39 of 51

It is possible to graph also the start up of the facility. During the first seconds the signal oscillates then after the pump started to work it grows up to 300mV. The signal becomes constant when the loop reaches the test temperature.

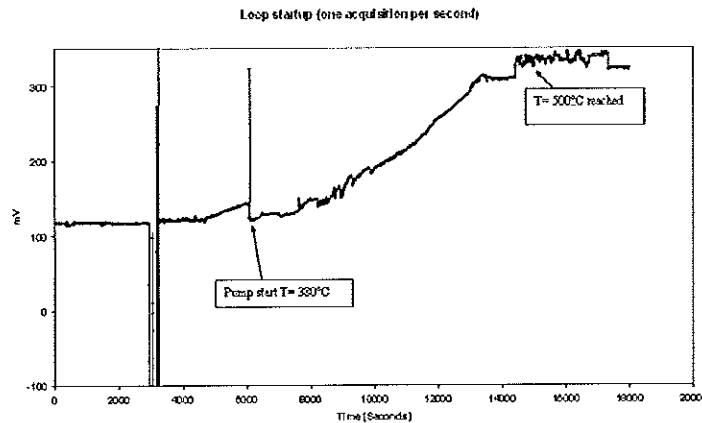
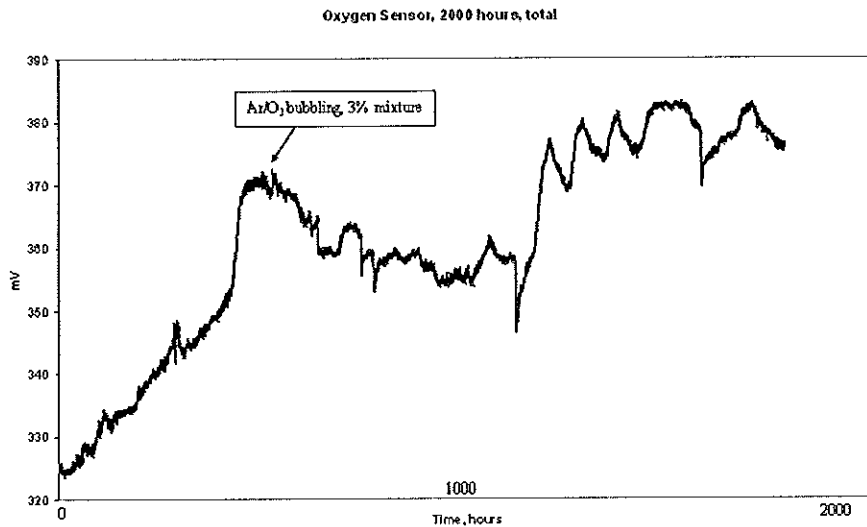

Conclusions

In PbBi, the two Bi|Bi₂O₃ sensors gave signals which were in good accordance with the theoretical ones in both plants. Also the In|In₂O₃ sensor gave outcome signals coherent with the theoretical data. Moreover the two sensors gave coherent signals in similar working conditions, allowing to start the design of a sensor for a pool configuration.

 FPN FIS ING Sezione Ingegneria Sperimentale	DESCRIZIONE DI SISTEMI DI PURIFICAZIONE E CONTROLLO DELL'OSSIGENO PER SISTEMI A PISCINA	DOCUMENT AdP ENEA-MSE LP3-D	ISSUE DATE 16/02/2009	PAGE 40 of 51
		IT-G-T-001	Rev : 3	

That led to the design and construction of an oxygen sensor adapt to pure Lead. In this case it was a technological innovation since, up to now, few data are available. The $\text{Bi|Bi}_2\text{O}_3$ sensor was recalibrated in pure lead and showed a behaviour comparable to the one in PbBi.

Only the magnitude of the outcome signal is slightly lower than in the LBE case.

The next step is to design and construct an oxygen sensor for a pool type reactor. This sensor will be tested in the frame of experimental campaigns, which will be performed in the CIRCE facility next year.

For the new "pool" sensor some obstacles should be overcome, such as the higher pressure field, the temperature variations and the insulation of the electrical cables.

As a matter of fact, in order to monitor the oxygen content in a pool deep nine meters, it is necessary to install some sensors.

Due to the different deepness they are loaded differently along their length and this can affect the ceramic glove. Moreover the temperature gradient along the pool affect both the ceramic and the electrical cables with the possibility to break the sensor.

ENEA EXPERIENCE WITH FILTERING DEVICES

Introduction

The liquid Pb, can be considered a high dispersion suspension of extremely fine particles of Pb, Bi, Fe, Cr, Mn oxides. As a function of experimental conditions, their concentration could be dangerous for the coolant use, possibly causing the separation of powders and slags of oxides near valves, pipes elbows, heat exchangers walls, with the possible risk of the plugging of the whole liquid metal loop system. These oxides form mainly due to excess of oxygen in the melt, coming from small leakages, failures in the oxygen control or problems from the original solid LBE or Pb ingots.

These phenomena have been seldomly observed in the ENEA loops (LECOR and CHEOPE) in which the liquid melt LBE and pure Pb are used for corrosion studies. Lead oxides as very thin black dust was observed in outgassing systems, while solid slags, mainly consisting of lead oxide and intermetallic compounds, created some problems in the CHEOPE loop, when the loop was run with LBE, where the oxygen concentration was kept between the interval 10^{-6} - 10^{-5} wt%, corresponding to the Iron oxidation Gibbs free energy and just below to the Pb one (about 10^{-4} wt%), at 400°C and a flow rate of 1 m/s ca.

The CHEOPE loop has been used for more than 10000 hours of experimental campaign for materials compatibility studies, as far as corrosion problems of structural steels with oxygen passivated surfaces are concerned. These experiments have been performed in LBE and pure Pb. The steels passivation is the reason for the relatively high oxygen content, which was controlled by means of gas bubbling and monitored by electrochemical sensors. Difficulties related to the oxygen control and small oxygen leakages during the corrosion specimen extraction, could be considered the most probable causes of some slags formation during the LBE experiments. These solid slags did accumulate on the hot part of

 FPN FIS ING Sezione Ingegneria Sperimentale	DESCRIZIONE DI SISTEMI DI PURIFICAZIONE E CONTROLLO DELL'OSSIGENO PER SISTEMI A PISCINA	DOCUMENT AdP ENEA-MSE LP3-D	ISSUE DATE 16/02/2009	PAGE
		IT-G-T-001	Rev : 3	41 of 51

the loop (which is non-isothermal) where they stuck near a pipe elbow. The composition of one of these slags is summarized in Table.

Compound	Concentration
PbO	40 wt% ca.
LBE (γ β phases)	50 wt% ca.
Fe, Al, Cr	10 wt % Ca.

The presence of such macroscopic slags inside a liquid metal loop can cause flow rate reduction, problems in controlling the dissolved oxygen and thus the experimental conditions for the corrosion tests, as well as possible plant plugging problems.

Their composition and the nature of the phenomenon causes suggest also that the formation of oxides is a continuous one. The role of intermetallic compounds like Pb_7Bi_3 has also been found to play an important role. The use of on-line continuous filtering techniques gathers a very high importance.

On the other hand, during the pure Pb experimental campaign, very small problems of coolant pollution were observed. After 5000 hours of in situ passivation experiments performed at 500°C, with the same conditions of the previous campaigns, no macroscopic slag was observed, and the production of the so called "black dust" was heavily reduced. Filters and purification devices were implemented also.

2. FILTER CONCEPTS

The variability of the slags and powders dimensions, suggests that the best filtering approach is the use of "capillary" layers, oriented mainly perpendicularly to the liquid flux, thus creating micro stagnant areas where the coagulation of slags and their separation is enhanced. According to Y. Orlov et. al. the best suggested material for filtering material is a multilayer glass fiber tissue, with 95 wt% ca. of SiO_2 . Its high temperature stability ($> 500^\circ C$) and the calculated filtering efficiency ($0.9-1.1 g-PbO/cm^3$) are the reason for this choice. The filter diameter was 100 mm.

A mechanical kind of filter was also tested. It consists of a three steps filtering device in which three poral filters of different meshes are set. The meshes are respectively: 50 μm , 30 μm , 20 μm , where the largest one is the first encountered by the LBE flow. A similar mechanical filtering system, having meshes of 30 μm , 20 μm and 10 μm was used during the filling of the CHEOPE III loop, keeping the temperature at 400°C

Experimental procedure

The filters were built in the ENEA Brasimone laboratory, using AISI 316L steel and a commercial fiberglass. The fiberglass one was also equipped with a termocouple.

It was put in a pipe in the hot part of the CHEOPE loop and kept at 400°C. Then the loop was started for the experiments in flowing HLM, with the LBE kept at 400°C, the pure Pb kept at 500°C and the flow rate at 1m/s. The oxygen concentration was actively controlled by means of gas bubbling and monitored by electrochemical oxygen sensors developed and built by IPPE, Obnisk. and by ENEA

 FPN FIS ING Sezione Ingegneria Sperimentale	DESCRIZIONE DI SISTEMI DI PURIFICAZIONE E CONTROLLO DELL'OSSIGENO PER SISTEMI A PISCINA	DOCUMENT AdP ENEA-MSE LP3-D	ISSUE DATE 16/02/2009	PAGE 42 of 51
		IT-G-T-001	Rev : 3	

Brasimone. Oxygen concentration was kept at 10^{-5} wt% ca. The composition of the filtered particles, as the one of the macroscopic slags, was determined by means of a Thermo-ARL X-ray fluorescence spectrometer and of a Philips X'Pert X-ray diffractometer for powder samples.

The mechanical filter was simply put between the melting tank and the CHEOPE III loop, thus filtering 300 litres ca. of HLM at 400°C. During this operation a blockage of the 10 µm mesh by oxides was observed only during the LBE experiments. The device was then dismantled and photographed. A bypass pipe line was built in parallel to the filtering device. The filtering disks were then replaced by a sintered tube of PORAL type having larger filtering surface (D=40mm, L=250mm, mesh=20µm). The results were acceptable, therefore it was used also for the initial LBE filling of LECOR (500 l) and CIRCE (7000 l)

Experimental data

During the 10000 hours corrosion experiment performed in the CHEOPE III loop, no flow rate decreases were observed. The oxygen probe signal remained quite stable, corresponding to the oxygen concentration required of 10^{-5} wt% ca. No plugging problems happened. No additional reducing gas bubbling was required.

After the draining of the loop, in both experiments the fiberglass filter was dismantled. It appeared clean and no macroscopic slags were observed, fig. 5, 6. The fiberglass containers were disassembled too and the solid particles trapped in it were separated and analyzed by means of X-ray diffractometry and fluorescence technique. In tables the average composition of the particles trapped in LBE and Pb are summarized.

Compound	Concentration
PbO	42 wt% ca.
LBE (γ β phases)	50 wt% ca.
Fe, Al, Cr	8 wt % Ca.

Compound	Concentration
PbO	25 wt% ca.
Pb	70 wt% ca.
Fe, Al, Cr	5 wt % Ca.

The composition in LBE is similar to the composition of the slags that were found in the loop without the filter. Again, no slags have been observed in flowing Lead, where the amount of filtered particles appeared to be extremely low.

The three porals array cleaned without plugging problems all the LBE melted during the filling of CHEOPE III. All macroscopic slags were stopped by the mechanical barrier. The pipe was not plugged and no bypass line was used.

 FPN FIS ING Sezione Ingegneria Sperimentale	DESCRIZIONE DI SISTEMI DI PURIFICAZIONE E CONTROLLO DELL'OSSIGENO PER SISTEMI A PISCINA	DOCUMENT AdP ENEA-MSE LP3-D	ISSUE DATE 16/02/2009	PAGE
		IT-G-T-001	Rev : 3	43 of 51

PRELIMINARY CONCLUSIONS AND ON-GOING ACTIVITIES

After this preliminary experiments, some conclusions can be summarized:

- The big slags found in the loop during previous experiments are the result of the aggregation in time of small PbO particles. The PbO slags act as small condensation nuclei that are able to keep particles of recrystallized LBE too.
- The fiberglass filter did not affect the flow rate of the CHEOPE III loop in 10000 hours of corrosion test.
- The composition of the compounds caught by the fiberglass filter is the same of the macroscopic slags found inside the loop pipeworks for LBE experiments. The filtering technique thus seems effective in adsorbing them.
- The selectivity towards PbO of the fiberglass is confirmed by the analyses performed after the Pb experiment.
- The absence of Bi had as a consequence the drastic reduction of oxides, confirming the possible active role of intermetallic compounds in the slag formation.
- More experiments are foreseen in order to better characterize this filtering technique. Both experiments were carried on at a fixed temperature. Future tests with filtering devices kept at different temperatures are foreseen, in order to assess the effect of temperature variation on the filtering process.
- The mechanical filtering of larger surface gave good macroscopic results during the filling of the CHEOPE III loop, by 300liters of HLM ca. No plugging problems happened, even though a bypass line construction could be taken into consideration.
- Further analyses on the characteristics of the slags trapped by the poral technique in terms of granulometry and composition are foreseen.
- The quantitative qualification of these filtering device is foreseen. A new small loop for their calibration is being sketched. Interchangeable on line filtering devices for liquid metal loops are foreseen too.
- The comparison between the two filtering techniques can in the end be preliminary summarized as follows:
 - The mechanical filtering could indeed be effective in eliminating macroscopic slags, but, after several hours of exercise inside the liquid metal in could plug itself, thus causing a possible pipe blockage. It could be stated that this kind of filters is a suitable device for facilities filling systems.
 - The fiberglass filtering demonstrated to be equally effective in terms of impurities removal; being a filter parallel to the liquid metal flow it should not obstruct the pipes paths. A preliminary confirmation of this statement comes from the constance of the HLM flow rate and from the relatively high stability of the electrochemical Oxygen sensor output. These data could suggest that this filtering technique could be suggested for an online slag removal device.
 - The extreme simplicity of this device suggests its use also in a large device, i.e. in the ELSY reactor.

 FPN FIS ING Sezione Ingegneria Sperimentale	DESCRIZIONE DI SISTEMI DI PURIFICAZIONE E CONTROLLO DELL'OSSIGENO PER SISTEMI A PISCINA	DOCUMENT AdP ENEA-MSE LP3-D	ISSUE DATE 16/02/2009	PAGE
		IT-G-T-001	Rev : 3	44 of 51

CHARACTERISTICS OF THE ICE OXYGEN SENSORS

The ICE oxygen sensors, supplied by IPPE, are presented in figure 1. The sensors have been calibrated by IPPE, and the following correlation was obtained to express the electromotive force as function of the oxygen activity in the melt:

$$E_{(mV)} = 0.131 - 1.5 \cdot 10^{-5} T_{(K)} (1 + 6.6 \log a_0) \quad (1)$$

for lead, and

$$E_{(mV)} = 0.088 - 1.78 \cdot 10^{-5} T_{(K)} - 9.907 \cdot 10^{-5} T_{(K)} \log a_0 \quad (2)$$

for LBE.

The characteristics of the sensors are reported in the table 1 .

Oxygen Activity Range, a_0 , [-]	$1 \cdot 10^{-6} - 1$
Maximum Working Pressure [MPa]	0.5
Maximum HLM Flow Velocity [m/s]	1.0
Maximum Temperature Variation Rate [°C/s]	10
HLM working temperature [°C]	350-650
Relative Deviation from Nominal Static Characteristic (NSC), %	±10
Time required to achieve the operating conditions, [h]	10

Table 1 Technical Performance for the ICE Oxygen Sensor [10]

 Sezione Ingegneria Sperimentale	DESCRIZIONE DI SISTEMI DI PURIFICAZIONE E CONTROLLO DELL'OSSIGENO PER SISTEMI A PISCINA	DOCUMENT	ISSUE DATE	PAGE
		AdP ENEA-MSE LP3-D	16/02/2009	
		IT-G-T-001	Rev : 3	45 of 51

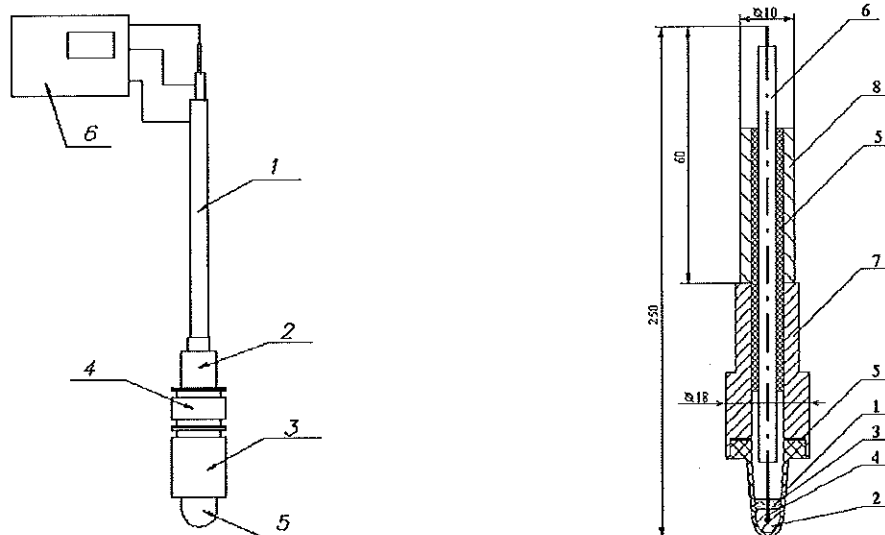

1 – two-shell potential terminal lead; 2 – sealed lead-in; 3 – metallic casing of ceramic sensitive element; 4 – adapter (transition part); 5 – ceramic sensitive element; 6 – measuring system

1 – Capsule Sensitive Element; 2- bismuth; 3 – bismuth oxide; 4 – electrode; 5 – glass ceramics; 6 – potential terminal; 7- casing; 8 – sealed lead-in.

Figure 1. View of the ICE oxygen sensors

CHARACTERISTICS OF THE ICE MASS EXCHANGER

A Mass Exchanger (MX) is installed to perform the solid phase control for the CIRCE facility, assuring the corrosion protection of the test section and its fault-free operation; it is a stainless steel cylindrical vessel having an 80 mm diameter and a 1500 mm length (see fig. 2).

Inside the vessel there is a section between two slot grids filled with spheroids of lead oxide (O.D 9-11 mm), as shown in figure 3 . A solid phase oxidizer (about 12 kg of PbO spheroids) is dissolved in lead flow causing the release of oxygen, which is transported by the coolant flow throughout the circuit.

ENEA FPN FIS ING Sezione Ingegneria Sperimentale	DESCRIZIONE DI SISTEMI DI PURIFICAZIONE E CONTROLLO DELL'OSSIGENO PER SISTEMI A PISCINA	DOCUMENT AdP ENEA-MSE LP3-D	ISSUE DATE 16/02/2009	PAGE
		IT-G-T-001	Rev : 3	46 of 51

A gas pipe (I.D. 8 mm) is welded to the cover of the MX, so that total length of the device is about 2040 mm. The external gas circuit is designed to feed the MX and, as a consequence, to supply liquid metal enriched by oxygen to the CIRCE pool.

During a working cycle (see fig. 4) inert gas is extracted by a compressor from the CIRCE cover gas and supplied through gas pipeline to mass exchanger; pressurized gas push into the CIRCE pool liquid metal enriched with oxygen.

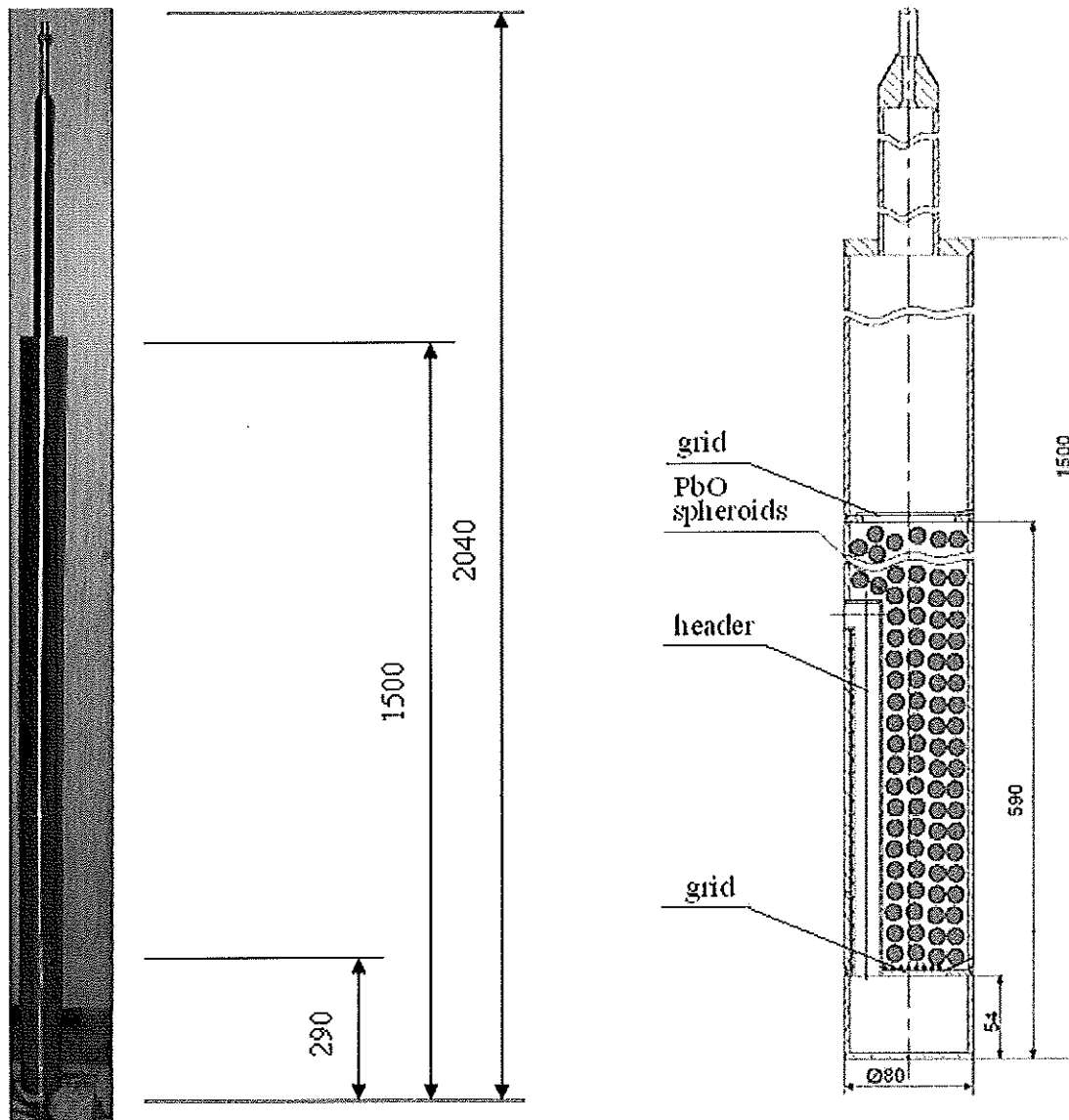

ENEA FPN FIS ING Sezione Ingegneria Sperimentale	DESCRIZIONE DI SISTEMI DI PURIFICAZIONE E CONTROLLO DELL'OSSIGENO PER SISTEMI A PISCINA	DOCUMENT AdP ENEA-MSE LP3-D	ISSUE DATE 16/02/2009	PAGE
		IT-G-T-001	Rev : 3	47 of 51

Figure 2 ICE Mass Exchanger

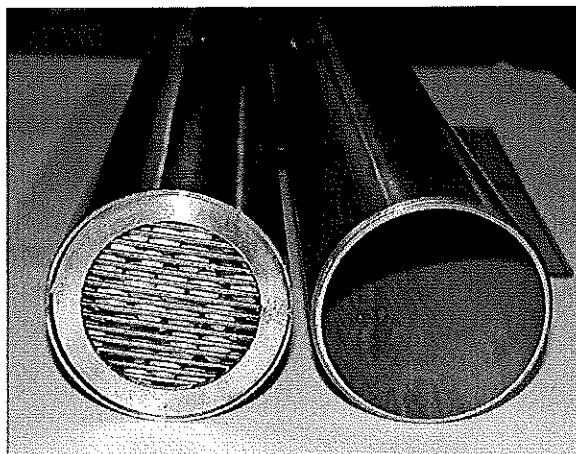

Figure 3. Lead Oxide Spheroids in the Mass Exchanger

Moreover, an automatic control system allows to manage the mass exchanger; in fact, changing the outlet pressure of the compressor, it is possible to control the amount of liquid metal flowing out from the MX into the pool, and so the oxygen quantity inserted in the system, as depicted in figure 4.

ENEA FPN FIS ING Sezione Ingegneria Sperimentale	DESCRIZIONE DI SISTEMI DI PURIFICAZIONE E CONTROLLO DELL'OSSIGENO PER SISTEMI A PISCINA	DOCUMENT AdP ENEA-MSE LP3-D	ISSUE DATE 16/02/2009	PAGE
		IT-G-T-001	Rev : 3	48 of 51

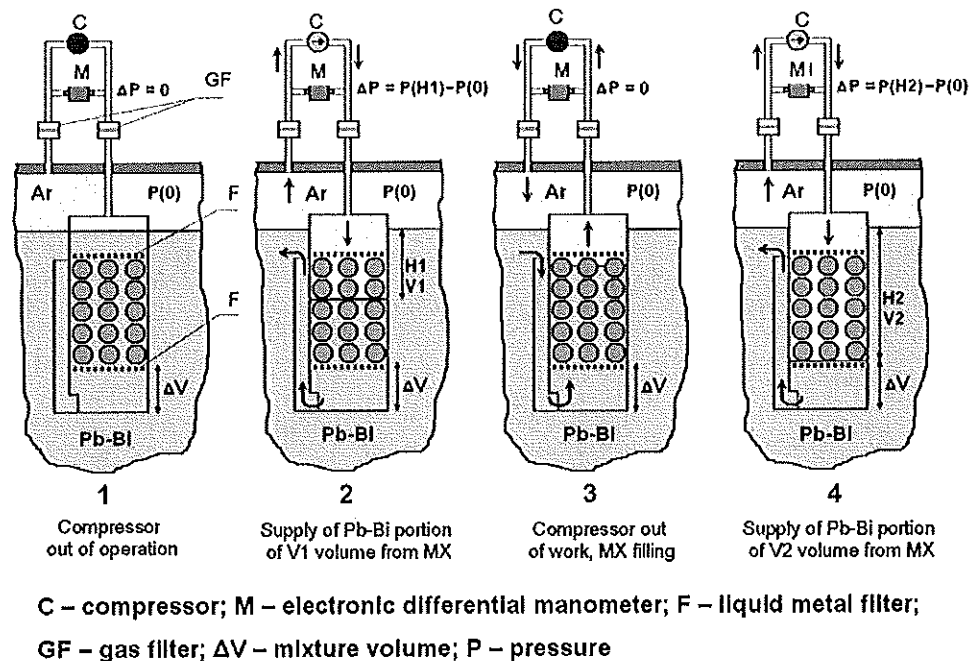



Figure 4. Mass Exchanger Working Principle

On the basis of the results obtained in the frame of the experimental and analytical activities performed on HLM system, the following considerations can be made.

- In a HLM coolant, oxygen is always present both in the dissolved form and as various oxide compositions (most probably, in the dissolved or colloidal form). These oxide compositions can disintegrate, yielding oxygen at temperatures below ~ 500 °C, and created, consuming the oxygen dissolved in melt at temperatures above ~ 500 °C. The presence of various oxide compositions in the coolant implies that the amount of oxygen present in it may exceed the calculated values determined by the oxygen sensor by many orders of magnitude. Since oxide compositions are thermodynamically less stable than Fe_3O_4 , the oxygen present in the oxide compositions is “active” and can take part to the surface passivation.
- The basic processes and factors influencing the pattern of the non-isothermal distribution of dissolved oxygen in the coolant are the following:
 - interaction of oxygen and metallic impurities dissolved in the coolant;
 - disintegration and formation of oxide phases;

 FPN FIS ING Sezione Ingegneria Sperimentale	DESCRIZIONE DI SISTEMI DI PURIFICAZIONE E CONTROLLO DELL'OSSIGENO PER SISTEMI A PISCINA	DOCUMENT AdP ENEA-MSE LP3-D	ISSUE DATE 16/02/2009	PAGE
		IT-G-T-001	Rev : 3	49 of 51

- the presence in the circuit of sources (for instance, PbO) and sinks (for instance, diffusive yield of steel components, oxidation of steel surface) of oxygen;
 - working temperature;
 - the rate of coolant circulation and the rate of temperature variation in the circuit;
 - total amount of oxygen and metallic impurities in coolant.
- Sensors gives only the local oxygen content, so for oxygen control it is necessary to use at least three oxygen sensors. Sensors should also be placed in zones with maximum, minimum and average values of temperature. Presently, it is impossible to have an analytical relationship for the dissolved oxygen distribution in the coolant for non-isothermal systems. Therefore even a rough control of mass transfer and prediction of the thermodynamic situation in the system are impossible adopting a single oxygen sensor.

REFERENCES

- [1] Handbook on Lead-bismuth Eutectic Alloy and Lead Properties, Materials Compatibility, Thermal-hydraulics and Technologies, 2007 Edition, NEA No. 6195
- [2] N.E. Todreas, M. S. Kazimi, *Nuclear System I, Thermal Hydraulic Fundamentals*, Taylor&Francis, 1993.
- [3] H.Grabner, M.Rieger, “*Experimentelle Untersuchung des Wärmeübergangs an Flüssigmetallen in Parallel Durchstromten Rohrbündeln bei Konstanter und Exponentieller Wärmeflussdichtverteilung*”, Atomkernenergie, Bd. 19, n. 1, S, 23, (1972).
- [4] I.E. Idelchick, Handbook of Hydraulic Resistance, 3rd Edition, Begell House.

 FPN FIS ING Sezione Ingegneria Sperimentale	DESCRIZIONE DI SISTEMI DI PURIFICAZIONE E CONTROLLO DELL'OSSIGENO PER SISTEMI A PISCINA	DOCUMENT AdP ENEA-MSE LP3-D	ISSUE DATE 16/02/2009	PAGE
		IT-G-T-001	Rev : 3	50 of 51

- [5] Moreau V., Report CRS4, “*Numerical CFD simulation in support to the EUROTRANS Integral System Experiment: Spacer Grid and Lower Grid Assembly Pressure Drops*”, 2007.
- [6] R. W. Lockart, R. C. Martinelli, “*Proposed correlation of data for isothermal two-phase two-component flow in pipes*”, Chem. Eng. Prog. 45:no. 39, 1949.
- [7] A. Bejan, A. D. Kraus, “*Heat Transfer Handbook*”, John Wiley & Sons, 2003.
- [8] Moreau V., Report CRS4, “*Numerical CFD simulation in support to the EUROTRANS Integral System Experiment: Two-phase flow separation a the gas-lift pump top*”, 2008.
- [9] Moreau V., Report CRS4, “*Numerical CFD simulation in support to the EUROTRANS Integral System Experiment: Heat Exchanger Characterization*”, 2008
- [10] ISTC Project No. 3020, “*Development Of Oxygen Sensors, Systems Of Control Of Oxygen Content In Lead Coolants For Test Loops And Facilities*” 2007
- [11] Konys J., Musher H., Vob Z., Wedemeyer O., “*Development of Oxygen Meter for the use in Lead-Bismuth*”, Journal of Nuclear Material 296 (2001), 289-294

 FPN FIS ING Sezione Ingegneria Sperimentale	DESCRIZIONE DI SISTEMI DI PURIFICAZIONE E CONTROLLO DELL'OSSIGENO PER SISTEMI A PISCINA	DOCUMENT AdP ENEA-MSE LP3-D	ISSUE DATE 16/02/2009	PAGE 51 of 51
		IT-G-T-001	Rev : 3	

Distribution list:

G, Coccoluto, ENEA

L. Moreschi, ENEA

M. Tarantino, ENEA

M. Utili, ENEA

P. Agostini, ENEA

A. Renieri, ENEA

S. Monti, ENEA