



Ente per le Nuove tecnologie,  
l'Energia e l'Ambiente



*Ministero dello Sviluppo Economico*

## **RICERCA SISTEMA ELETTRICO**

---

# **NEA-WPFC/FCTS Benchmark for Fuel Cycle Scenarios Study with COSI6**

**G. Grasso, S. Monti, M. Sumini**

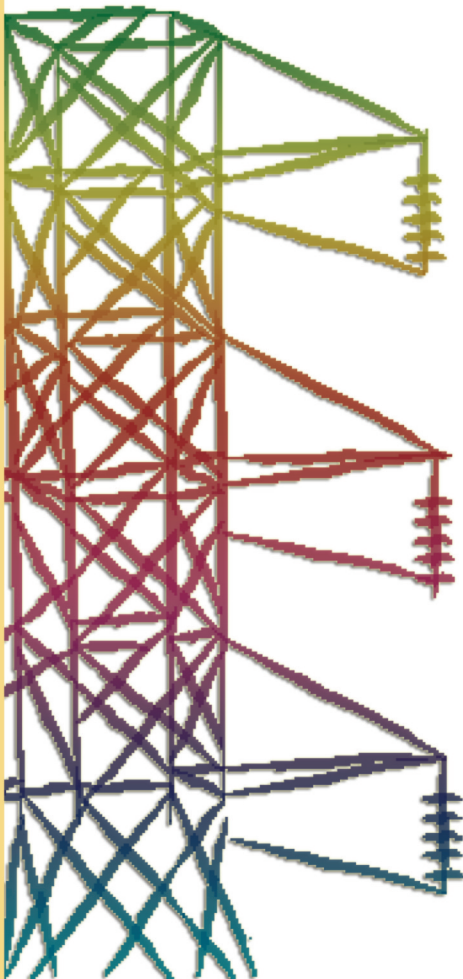



Ente per le Nuove tecnologie,  
l'Energia e l'Ambiente



*Ministero dello Sviluppo Economico*

RICERCA SISTEMA ELETTRICO

## NEA-WPFC/FCTS Benchmark for Fuel Cycle Scenarios Study with COSI6

*G. Grasso, S. Monti, M. Sumini*



NEA-WPFC/FCTS BENCHMARK FOR FUEL CYCLE SCENARIOS STUDY WITH COSI6

G. Grasso, M. Sumini (Laboratori di Ingegneria nucleare – LIN – di Montecuccolino,  
Dipartimento DIENCA dell'Università di Bologna)

S. Monti (ENEA)

Aprile 2009

Report Ricerca Sistema Elettrico

Accordo di Programma Ministero dello Sviluppo Economico – ENEA

Area: Produzione e fonti energetiche

Tema: Nuovo Nucleare da Fissione

Responsabile Tema: Stefano Monti, ENEA

	<b>Centro Ricerche Bologna</b>	<b>Sigla di identificazione</b> FPN – P9LU-034	Rev. 0	Distrib. L	Pag. 2	di 60
---	--------------------------------	---	-----------	---------------	-----------	----------

## INDEX

1	INTRODUCTION .....	3
2	DEPLETION CALCULATIONS .....	4
2.1	UOX fuel for PWRs .....	4
2.2	MOX fuel for PWRs.....	4
2.3	MOX fuel for Na-FRs.....	5
3	TRANSITION SCENARIOS .....	5
3.1	Open cycle .....	7
3.2	Monorecycling of Pu in PWRs.....	7
3.3	Monorecycling of Pu in PWRs and deployment of Gen-IV FRs for Pu and MAs recycling.....	8
4	COMPUTATIONAL SET UP .....	9
4.1	Scenario I.....	9
4.2	Scenario II .....	9
4.3	Scenario III.....	10
5	BENCHMARK RESULTS .....	11
5.1	Depletion Calculations .....	11
5.1.1	PWR UOX .....	12
5.1.2	PWR MOX.....	13
5.1.3	Na-FR MOX.....	14
5.2	Scenarios Simulations.....	15
5.2.1	UOX open cycle.....	15
5.2.2	Pu monorecycling in PWRs .....	24
5.2.3	Pu monorecycling towards Pu+MAs recycling in FRs .....	41
6	CONCLUDING REMARKS .....	58
7	ACKNOWLEDGEMENTS .....	58
A	LIST OF ACRONYMS .....	59
	REFERENCES .....	60

	<b>Centro Ricerche Bologna</b>	<b>Sigla di identificazione</b>	Rev.	Distrib.	Pag.	di
		FPN – P9LU-034	0	L	3	60

## 1 INTRODUCTION

The ENEA participation to the Expert Group on Fuel Cycle Transition Scenarios Studies (FCTS) of NEA-WPFC aims at the identification and analysis of several possible scenarios for nuclear fuel cycle management. In particular, ENEA activity is being focused on three main branches:

1. the analysis of national and regional scenarios, to advance sustainable hypotheses for the development of cooperative nuclear fuel cycle policies and the installation of common facilities;
2. the generation of code specific libraries to model the burn up behaviour of new reactors (in particular, Gen-IV fast reactors) and transmuters (in particular, ADS like facilities such as EFIT) for achievable scenarios;
3. the use and benchmarking of the COSI6 [1] code for fuel cycle analysis, developed and maintained at CEA-Cadarache.

To begin the ENEA WPFC-FCTS participation, an initial set-up phase is needed, in order to align the internal knowledge about the scenarios simulation instruments and techniques with other Working Party members.

A series of benchmarking exercises have been performing by the WPFC [2] to take aim at covering the most part of cases for both statical, single reactor Burn Up (BU) analysis and more complex scenarios with different types of reactors running together. The benchmark is therefore divided in two parts:

1. the first one is devoted to depletion calculations of three different reactors:
  - a PWR loaded with UOX fuel;
  - a PWR loaded with MOX (U, Pu and Am) fuel;
  - a Na-FR loaded with MOX (U, Pu, Am, Np and Cm) fuel;
2. the second one is dedicated to three transition scenarios:
  - an open cycle in PWRs;
  - the monorecycling of Plutonium in PWRs;
  - the monorecycling of Plutonium in PWRs and then the deployment of Gen IV fast reactors (FRs) recycling Plutonium and Minor Actinides (MAs).

A more detailed presentation of the benchmark exercises will be presented in the following § 2 and 3.

All the described cases have then been analyzed with the COSI6 code for fuel cycle analysis, and the results, reported in § 5, will be presented to the FCTS Expert Group in April, 2008.

## 2 DEPLETION CALCULATIONS

The three benchmark cases for depletion calculations are here presented and analyzed, as described in the second version of the WPFC-FCTS benchmark specification. For each case, the exact isotopic composition of the fuel is given, and several information about its BU regime – needed to set up the COSI6 simulation model – indicated.

### 2.1 UOX fuel for PWRs

The UOX fuel, whose composition is presented in Table 1, is examined after being irradiated in a 900 MWe PWR (standard 17x17 rods fuel assembly type FRAGEMA: 264 fuel rods and no extra water hole) at a BU rate of 60 GWd/t (1760 EFPD) and a subsequent 5 years cooling period.

Nuclide	wt %
U-234	0.0445
U-235	4.95
U-238	95.0055

Table 1: Initial composition for UOX fuel.

### 2.2 MOX fuel for PWRs

The MOX fuel, whose composition is presented in Table 2, is examined assuming the same BU conditions as UOX in the previous case.

Nuclide	wt %
U-235	0.2056
U-238	90.7684
Pu238	0.2816
Pu239	4.6565
Pu240	2.1951
Pu241	1.0606
Pu242	0.7257
Am241	0.1065

Table 2: Initial composition for MOX PWR fuel.

### 2.3 MOX fuel for Na-FRs

For the Na-FR MOX fuel (whose composition is presented in Table 3), a more detailed description of the fuel BU conditions is given: a BU rate of 136 GWd/t (1700 EFPD) within a 1.45 GWe, 40% efficient Na-FR with a production factor of 76% has been used, and a subsequent cooling time of 5 years applied.

Nuclide	wt %
U-234	0.000538
U-235	0.188200
U-238	75.091897
Pu238	0.875900
Pu239	12.670000
Pu240	6.889000
Pu241	0.702600
Pu242	1.074000
Am241	0.858200
Am242m	0.048340
Am243	0.511400
Np237	0.500000
Cm242	0.002424
Cm243	0.006541
Cm244	0.469900
Cm245	0.083910
Cm246	0.027150

Table 3: Initial composition for MOX Na-FR fuel.

## 3 TRANSITION SCENARIOS

The three scenarios presented in § 1 all refer to a 120 years period, with a constant installed power of 60 GWe and a constant electrical annual production of 430 TWhe (corresponding to a 81.76% constant load factor). The exact specification parameters for each type of reactor are presented in Table 4.

		UOX PWR	MOX PWR	FR
<b>Fuels/blankets</b>				
Burn Up				
Fissile	GWd/tHM	60	60	136
Axial blanket	GWd/tHM	-	-	15
Radial blanket	GWd/tHM	-	-	25
Minimum cooling time	year	5	5	2
Fabrication time	year	2	2	2
Fresh fuel <sup>235</sup> U enrichment	%	4.95	0.25	0.25
Equivalent Pu content	%	-	-	14.5
Moderation ratio		2	2	-
<b>Cores</b>				
Electrical nominal power	GW	1.5	1.5	1.45
Efficiency	%	34	34	40
Production factor	%	76	76	76
Heavy metal masses				
Fissile	tons	128.9	128.9	41.4
Axial blanket	tons	-	-	18
Radial blanket	tons	-	-	13.5
Breeding gain		-	-	≈1
Cycle length	EFPD	410	410	340
Core management				
Fuel		1/4	1/4	1/5
Radial blanket		-	-	1/8
<b>Treatment plants</b>				
Priorities		FIFO	FIFO	FIFO
				First fuel then blankets
Losses (U and Pu)	%	0.1	0.1	0.1

Table 4: Data compilation for the benchmark scenarios study.



The description of the temporal evolutions of the three scenarios are depicted in Figures 1-3 and explained in Tables 5-6.

### 3.1 Open cycle

The temporal evolution of the first scenario is depicted in Figure 1: a constant installed power by means of standard UOX PWRs is simulated for the whole scenario period.

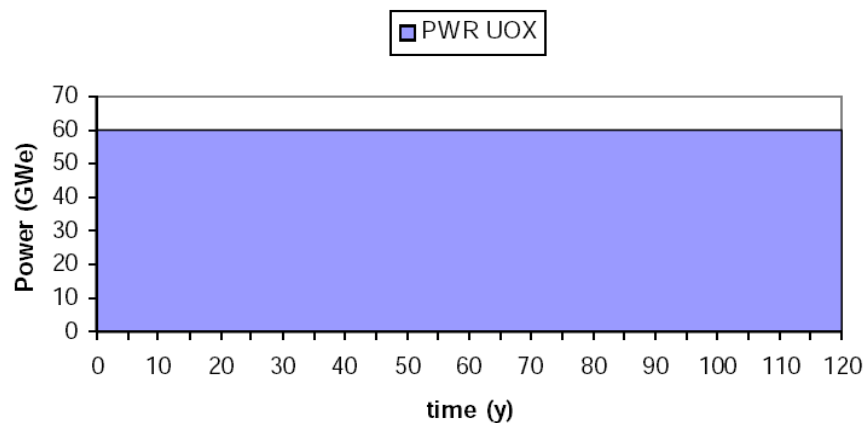

Figure 1: Time evolution of the first scenario benchmark case (open cycle).

### 3.2 Monorecycling of Pu in PWRs

The temporal evolution of the second scenario is depicted in Figure 2 and explained in Table 5. It is assumed that a linear variation occurs during the transitory period of MOX PWRs start up.

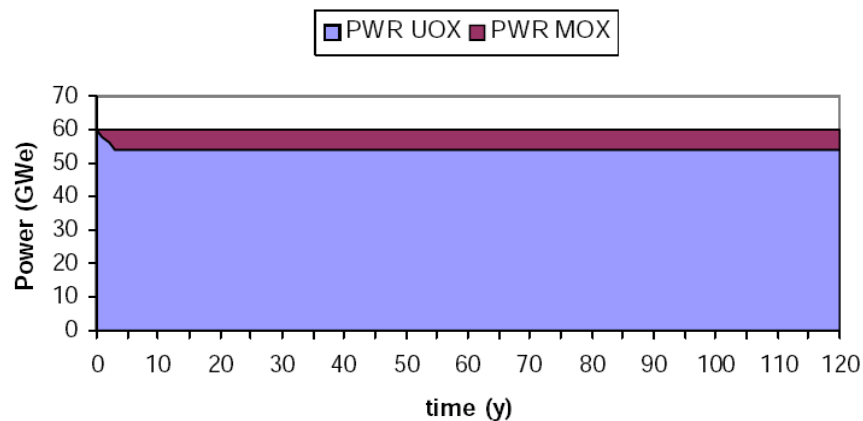

Figure 2: Time evolution of the second scenario benchmark case (monorecycling of Plutonium).

Time [y]	PWR UOX [GWe]	PWR MOX [GWe]
0	60	0
3	54	6
120	54	6

Table 5: Installed capacity for different reactors during Scenario II.

### 3.3 Monorecycling of Pu in PWRs and deployment of Gen-IV FRs for Pu and MAs recycling

The temporal evolution of the third scenario is depicted in Figure 3 and explained in Table 6. Linear variations are supposed for each transitional period.

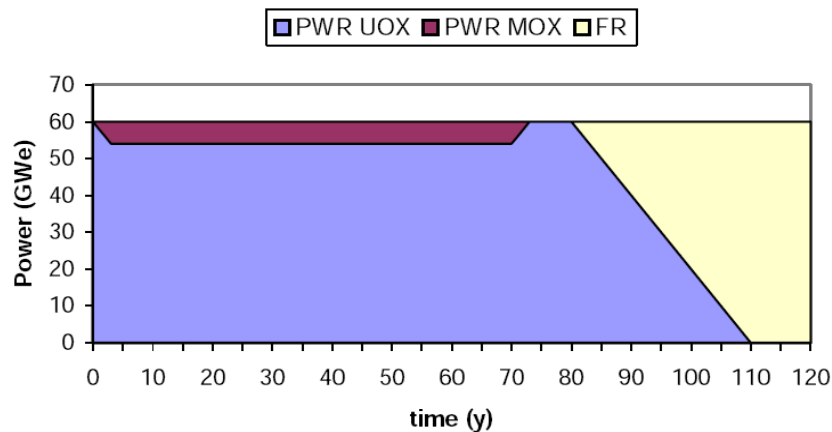

Figure 3: Time evolution of the third scenario benchmark case (monorecycling of Pu and subsequent deployment of Gen-IV FRs for Pu+MAs recycling).

Time [y]	PWR UOX [GWe]	PWR MOX [GWe]	FR [GWe]
0	60	0	0
3	54	6	0
70	54	6	0
73	60	0	0
80	60	0	0
110	0	0	60
120	0	0	60

Table 6: Installed capacity for different reactors during Scenario III.

<b>ENEA</b>	<b>Centro Ricerche Bologna</b>	<b>Sigla di identificazione</b>	Rev.	Distrib.	Pag.	di
		FPN – P9LU-034	0	L	9	60

## 4 COMPUTATIONAL SET UP

All the simulations have been executed with the COSI6 [3] v.2.0.4 code for linux i-32 systems, on an Intel workstation with Intel Core 2 Duo E6700 processor, 2 Gb RAM and the GNU/Linux Debian “Etch” operative system. The Java platform to run the code onto is the SUN one, version 1.5.12, with both JDK and JRE packages installed.

In particular, the COSI6 version used includes the CESAR4 BU code, version 4.3. Among the available libraries to such code, the following ones have been chosen for the three cases:

- UOX 4 BBL for UOX PWRs;
- MOXP 800 BBL for MOX PWRs;
- MOXS 813 BBL for FRs fuel,  
UOX 811 BBL for FRs axial blanket and  
UOX 812 BBL for FRs radial blanket.

The scenario schemes modelled with COSI6 for the three simulations are presented and discussed in the following subsections.

### 4.1 Scenario I

The scheme modelled for the simulation of the first scenario is a linear one, with just one kind of fuel and no recycling. The mass flows from the mine (Natural Uranium, NU) through the reactors and towards the spent fuel disposal, as depicted in Figure 4.

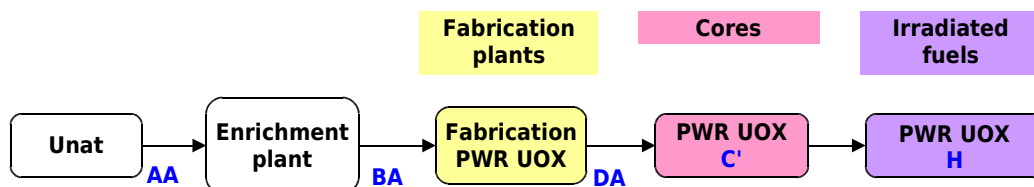

Figure 4: Simulation model of the first scenario.

### 4.2 Scenario II

The scheme modelled for the simulation of the second scenario presents two branches, one for each type of involved reactor (UOX and MOX PWRs). A backward flow feeds MOX PWRs reactors in order to recycle the Pu produced in UOX PWRs. Although it was not clearly specified by the scheme presented by the WPFC (represented in Figure 5), the monorecycling of Pu has been achieved by reprocessing only the spent UOX.

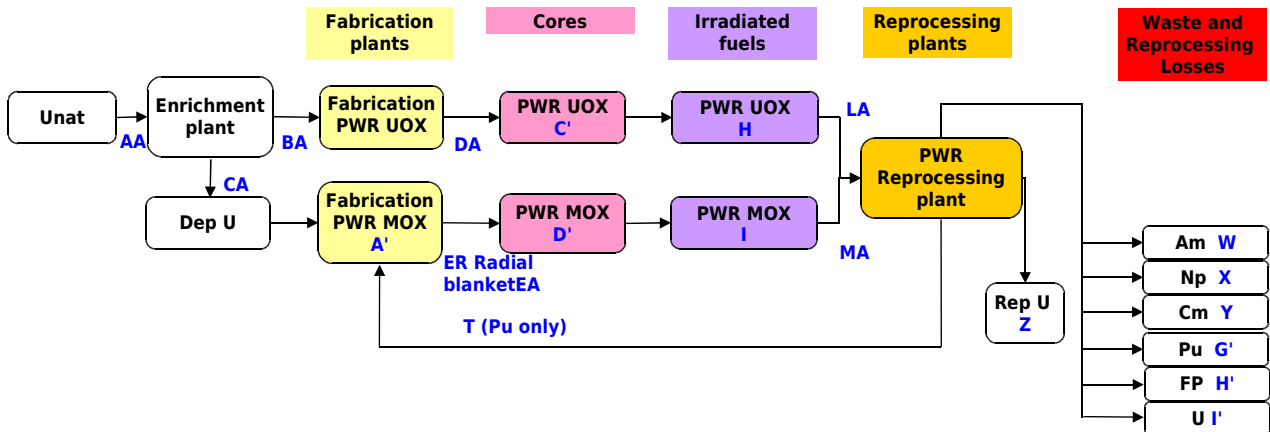

Figure 5: Simulation model of the second scenario.

### 4.3 Scenario III

The last scenario has been modelled as depicted in Figure 6. Several branches are needed to correctly feed the three kind of reactors implemented in the scenario (UOX and MOX PWRs and FRs) with the proper fuels and blankets (only for FRs). Different reprocessing facilities have been introduced to correctly model the two recycling phases (monorecycling of Pu in MOX PWRs first, and then full recycling of Pu and MAs in FRs) by differencing the spent fuels flows.

The equivalence reactivity coefficients needed to define the equivalence model for Gen-IV FRs BU have been kindly provided by dr. M. Meyer [4] at CEA-Cadarache.

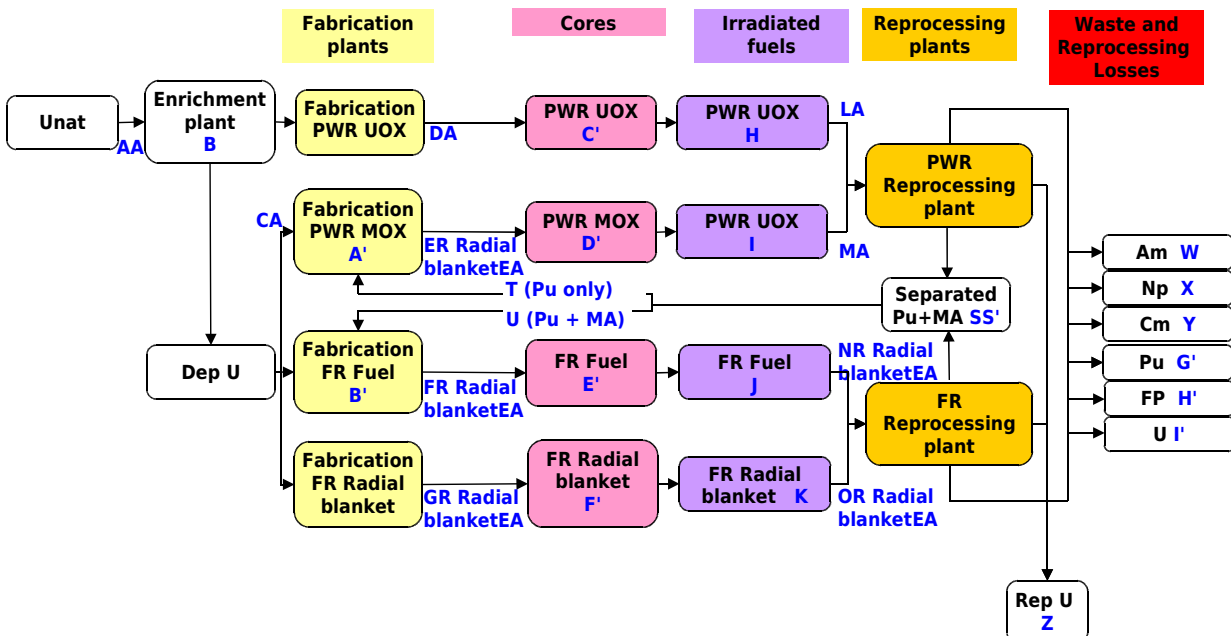



Figure 6: Simulation model of the third scenario.

	<b>Centro Ricerche Bologna</b>	<b>Sigla di identificazione</b> FPN – P9LU-034	Rev. 0	Distrib. L	Pag. 11	di 60
---	--------------------------------	---	-----------	---------------	------------	----------

## 5 BENCHMARK RESULTS

### 5.1 Depletion Calculations

The three depletion benchmark cases have been compiled for COSI6 calculation following the given specifications.

The missing informations for a complete definition of the scenarios have been deduced from Table 4 concerning the transition scenarios benchmarks. In particular it was assumed:

- a constant 0.8176 load factor;
- a net yield of 0.34 for PWRs and of 0.4 for FRs;
- a 1.45 GWe net electrical power for FRs;
- a moderation ratio (only for PWRs) equal to 2;
- a fuel mass respectively equal to 128.9 tons for PWRs and 41.4 tons for FRs.

Under such hypotheses, the obtained results are presented in the following subsections.

### 5.1.1 PWR UOX

	BOC	EOC	5y cooling
isotope	[g/ton iHM]		
U232	0,000E+00	2,778E-03	3,674E-03
U234	4,450E+02	2,202E+02	2,156E+02
U235	4,950E+04	7,737E+03	7,592E+03
U236	0,000E+00	6,828E+03	6,877E+03
U238	9,501E+05	9,084E+05	9,091E+05
U	1,000E+06	9,232E+05	9,238E+05
Pu236	0,000E+00	3,804E-03	1,043E-03
Pu238	0,000E+00	5,994E+02	4,915E+02
Pu239	0,000E+00	6,598E+03	6,375E+03
Pu240	0,000E+00	3,095E+03	3,111E+03
Pu241	0,000E+00	2,032E+03	1,563E+03
Pu242	0,000E+00	1,123E+03	1,127E+03
Pu	0,000E+00	1,345E+04	1,267E+04
Am241	0,000E+00	1,407E+02	4,711E+02
Am242M	0,000E+00	1,534E+00	1,352E+00
Am243	0,000E+00	3,722E+02	2,938E+02
Am	0,000E+00	5,144E+02	7,663E+02
Np237	0,000E+00	9,151E+02	9,018E+02
Cm242	0,000E+00	1,270E+01	2,562E-02
Cm243	0,000E+00	1,338E+00	1,737E+00
Cm244	0,000E+00	1,720E+02	1,226E+02
Cm245	0,000E+00	1,201E+01	1,046E+01
Cm246	0,000E+00	3,045E+00	1,458E+00
Cm247	0,000E+00	0,000E+00	0,000E+00
Cm248	0,000E+00	0,000E+00	0,000E+00
Cm	0,000E+00	2,011E+02	1,363E+02
Cf252			
Sr90			
Zr95	0,000E+00	0,000E+00	0,000E+00
Tc99	0,000E+00	1,395E+03	1,396E+03
Ru106			
I129	0,000E+00	3,052E+02	3,059E+02
Cs133	0,000E+00	1,890E+03	1,868E+03
Cs134	0,000E+00	2,611E+02	2,717E+02
Cs135	0,000E+00	8,249E+02	8,212E+02
Cs137	0,000E+00	2,161E+03	2,160E+03
Eu154			
total FP			

### 5.1.2 PWR MOX

	BOC	EOC	5y cooling
isotope	[g/ton iHM]		
U232	0,000E+00	4,220E-04	8,636E-04
U234	0,000E+00	1,100E+02	2,316E+02
U235	2,056E+03	8,490E+02	8,563E+02
U236	0,000E+00	2,530E+02	2,704E+02
U238	9,077E+05	8,730E+05	8,733E+05
U	9,097E+05	8,742E+05	8,747E+05
Pu236	0,000E+00	6,920E-04	2,047E-04
Pu238	2,816E+03	3,140E+03	3,174E+03
Pu239	4,657E+04	1,910E+04	1,910E+04
Pu240	2,195E+04	1,750E+04	1,762E+04
Pu241	1,061E+04	1,000E+04	7,871E+03
Pu242	7,257E+03	8,460E+03	8,463E+03
Pu	8,920E+04	5,820E+04	5,623E+04
Am241	1,065E+03	1,940E+03	3,789E+03
Am242M	0,000E+00	3,970E+01	3,875E+01
Am243	0,000E+00	2,600E+03	2,601E+03
Am	1,065E+03	4,580E+03	6,429E+03
Np237	0,000E+00	1,550E+02	1,965E+02
Cm242	0,000E+00	1,450E+02	1,841E-01
Cm243	0,000E+00	1,670E+01	1,492E+01
Cm244	0,000E+00	1,620E+03	1,345E+03
Cm245	0,000E+00	2,060E+02	2,060E+02
Cm246	0,000E+00	2,120E+01	2,122E+01
Cm247	0,000E+00	0,000E+00	0,000E+00
Cm248	0,000E+00	0,000E+00	0,000E+00
Cm	0,000E+00	2,009E+03	1,587E+03
Cf252			
Sr90			
Zr95	0,000E+00	0,000E+00	0,000E+00
Tc99	0,000E+00	1,400E+03	1,402E+03
Ru106			
I129	0,000E+00	3,720E+02	3,717E+02
Cs133	0,000E+00	1,920E+03	1,922E+03
Cs134	0,000E+00	2,110E+02	2,108E+02
Cs135	0,000E+00	1,610E+03	1,608E+03
Cs137	0,000E+00	2,150E+03	2,148E+03
Eu154			
total FP			

### 5.1.3 Na-FR MOX

	BOC	EOC	5y cooling
isotope	[g/ton iHM]		
U232	0,000E+00	4,500E-02	7,856E-02
U234	5,380E+00	3,200E+02	6,011E+02
U235	1,882E+03	6,320E+02	6,478E+02
U236	0,000E+00	2,630E+02	3,246E+02
U238	7,509E+05	6,500E+05	6,503E+05
U	7,528E+05	6,512E+05	6,519E+05
Pu236	0,000E+00	5,300E-02	1,572E-02
Pu238	8,759E+03	7,830E+03	7,692E+03
Pu239	1,267E+05	9,940E+04	9,936E+04
Pu240	6,889E+04	6,740E+04	6,793E+04
Pu241	7,026E+03	9,090E+03	7,139E+03
Pu242	1,074E+04	9,040E+03	9,042E+03
Pu	2,221E+05	1,928E+05	1,912E+05
Am241	8,582E+03	4,940E+03	6,391E+03
Am242M	4,834E+02	3,440E+02	3,364E+02
Am243	5,114E+03	4,020E+03	4,014E+03
Am	1,418E+04	9,304E+03	1,074E+04
Np237	5,000E+03	2,500E+03	2,571E+03
Cm242	2,424E+01	1,620E+02	9,023E-01
Cm243	6,541E+01	6,350E+01	5,694E+01
Cm244	4,699E+03	4,810E+03	3,972E+03
Cm245	8,391E+02	8,950E+02	8,952E+02
Cm246	2,715E+02	3,280E+02	3,279E+02
Cm247	0,000E+00	0,000E+00	0,000E+00
Cm248	0,000E+00	0,000E+00	0,000E+00
Cm	5,899E+03	6,259E+03	5,253E+03
Cf252			
Sr90			
Zr95	0,000E+00	0,000E+00	0,000E+00
Tc99	0,000E+00	3,020E+03	3,021E+03
Ru106			
I129	0,000E+00	8,320E+02	8,319E+02
Cs133	0,000E+00	4,600E+03	4,596E+03
Cs134	0,000E+00	3,480E+02	3,481E+02
Cs135	0,000E+00	5,200E+03	5,204E+03
Cs137	0,000E+00	4,810E+03	4,809E+03
Eu154			
total FP			



## 5.2 Scenarios Simulations

In the present section the results for the three transition scenarios of the WPGC-FCTS benchmark are presented. The results have been formatted as specified in the sample table provided by the FCTS Expert Group.

### 5.2.1 UOX open cycle

For the UOX open cycle in traditional PWRs, the NU consumption (and, therefore, the enrichment Separative Working Units (SWUs) need) is the highest of the three cases. The annual NU outcome and the related SWUs required are shown in Table 7.

YEAR	Natural U needs	
	tons/year	SWU/year
-2	1,315E+04	1,007E+07
-1	1,315E+04	1,007E+07
0	1,315E+04	1,007E+07
1	0,000E+00	0,000E+00
2	1,315E+04	1,007E+07
3	1,315E+04	1,007E+07
4	0,000E+00	0,000E+00
5	1,315E+04	1,007E+07
6	1,315E+04	1,007E+07
7	0,000E+00	0,000E+00
8	1,315E+04	1,007E+07
9	1,315E+04	1,007E+07
10	0,000E+00	0,000E+00
11	1,315E+04	1,007E+07
12	1,315E+04	1,007E+07
13	0,000E+00	0,000E+00
14	1,315E+04	1,007E+07
15	1,315E+04	1,007E+07
16	0,000E+00	0,000E+00
17	1,315E+04	1,007E+07
18	1,315E+04	1,007E+07
19	0,000E+00	0,000E+00
20	1,315E+04	1,007E+07
21	1,315E+04	1,007E+07
22	0,000E+00	0,000E+00
23	1,315E+04	1,007E+07
24	1,315E+04	1,007E+07
25	0,000E+00	0,000E+00
26	1,315E+04	1,007E+07
27	1,315E+04	1,007E+07
28	0,000E+00	0,000E+00
29	1,315E+04	1,007E+07
30	1,315E+04	1,007E+07

31	1,315E+04	1,007E+07
32	0,000E+00	0,000E+00
33	1,315E+04	1,007E+07
34	1,315E+04	1,007E+07
35	0,000E+00	0,000E+00
36	1,315E+04	1,007E+07
37	1,315E+04	1,007E+07
38	0,000E+00	0,000E+00
39	1,315E+04	1,007E+07
40	1,315E+04	1,007E+07
41	0,000E+00	0,000E+00
42	1,315E+04	1,007E+07
43	1,315E+04	1,007E+07
44	0,000E+00	0,000E+00
45	1,315E+04	1,007E+07
46	1,315E+04	1,007E+07
47	0,000E+00	0,000E+00
48	1,315E+04	1,007E+07
49	1,315E+04	1,007E+07
50	0,000E+00	0,000E+00
51	1,315E+04	1,007E+07
52	1,315E+04	1,007E+07
53	0,000E+00	0,000E+00
54	1,315E+04	1,007E+07
55	1,315E+04	1,007E+07
56	0,000E+00	0,000E+00
57	1,315E+04	1,007E+07
58	1,315E+04	1,007E+07
59	0,000E+00	0,000E+00
60	1,315E+04	1,007E+07
61	1,315E+04	1,007E+07
62	1,315E+04	1,007E+07
63	0,000E+00	0,000E+00
64	1,315E+04	1,007E+07
65	1,315E+04	1,007E+07
66	0,000E+00	0,000E+00
67	1,315E+04	1,007E+07
68	1,315E+04	1,007E+07
69	0,000E+00	0,000E+00
70	1,315E+04	1,007E+07
71	1,315E+04	1,007E+07
72	0,000E+00	0,000E+00
73	1,315E+04	1,007E+07
74	1,315E+04	1,007E+07
75	0,000E+00	0,000E+00
76	1,315E+04	1,007E+07
77	1,315E+04	1,007E+07
78	0,000E+00	0,000E+00
79	1,315E+04	1,007E+07

80	1,315E+04	1,007E+07
81	0,000E+00	0,000E+00
82	1,315E+04	1,007E+07
83	1,315E+04	1,007E+07
84	0,000E+00	0,000E+00
85	1,315E+04	1,007E+07
86	1,315E+04	1,007E+07
87	0,000E+00	0,000E+00
88	1,315E+04	1,007E+07
89	1,315E+04	1,007E+07
90	0,000E+00	0,000E+00
91	1,315E+04	1,007E+07
92	1,315E+04	1,007E+07
93	0,000E+00	0,000E+00
94	1,315E+04	1,007E+07
95	1,315E+04	1,007E+07
96	1,315E+04	1,007E+07
97	0,000E+00	0,000E+00
98	1,315E+04	1,007E+07
99	1,315E+04	1,007E+07
100	0,000E+00	0,000E+00
101	1,315E+04	1,007E+07
102	1,315E+04	1,007E+07
103	0,000E+00	0,000E+00
104	1,315E+04	1,007E+07
105	1,315E+04	1,007E+07
106	0,000E+00	0,000E+00
107	1,315E+04	1,007E+07
108	1,315E+04	1,007E+07
109	0,000E+00	0,000E+00
110	1,315E+04	1,007E+07
111	1,315E+04	1,007E+07
112	0,000E+00	0,000E+00
113	1,315E+04	1,007E+07
114	1,315E+04	1,007E+07
115	0,000E+00	0,000E+00
116	1,315E+04	1,007E+07
117	1,315E+04	1,007E+07
118	0,000E+00	0,000E+00
119	0,000E+00	0,000E+00
120	0,000E+00	0,000E+00

Table 7: NU and SWUs annual needs for the open cycle scenario.

The corresponding enrichment and fabrication plants mass flows are listed in Table 8.

YEAR	Enriched U	UOX fabrication
	tons/y	tons/y
-2	1,289E+03	0,000E+00
-1	1,289E+03	0,000E+00
0	1,289E+03	1,289E+03
1	0,000E+00	1,289E+03
2	1,289E+03	1,289E+03
3	1,289E+03	0,000E+00
4	0,000E+00	1,289E+03
5	1,289E+03	1,289E+03
6	1,289E+03	0,000E+00
7	0,000E+00	1,289E+03
8	1,289E+03	1,289E+03
9	1,289E+03	0,000E+00
10	0,000E+00	1,289E+03
11	1,289E+03	1,289E+03
12	1,289E+03	0,000E+00
13	0,000E+00	1,289E+03
14	1,289E+03	1,289E+03
15	1,289E+03	0,000E+00
16	0,000E+00	1,289E+03
17	1,289E+03	1,289E+03
18	1,289E+03	0,000E+00
19	0,000E+00	1,289E+03
20	1,289E+03	1,289E+03
21	1,289E+03	0,000E+00
22	0,000E+00	1,289E+03
23	1,289E+03	1,289E+03
24	1,289E+03	0,000E+00
25	0,000E+00	1,289E+03
26	1,289E+03	1,289E+03
27	1,289E+03	0,000E+00
28	0,000E+00	1,289E+03
29	1,289E+03	1,289E+03
30	1,289E+03	0,000E+00
31	1,289E+03	1,289E+03
32	0,000E+00	1,289E+03
33	1,289E+03	1,289E+03
34	1,289E+03	0,000E+00
35	0,000E+00	1,289E+03
36	1,289E+03	1,289E+03
37	1,289E+03	0,000E+00
38	0,000E+00	1,289E+03
39	1,289E+03	1,289E+03
40	1,289E+03	0,000E+00
41	0,000E+00	1,289E+03
42	1,289E+03	1,289E+03
43	1,289E+03	0,000E+00

44	0,000E+00	1,289E+03
45	1,289E+03	1,289E+03
46	1,289E+03	0,000E+00
47	0,000E+00	1,289E+03
48	1,289E+03	1,289E+03
49	1,289E+03	0,000E+00
50	0,000E+00	1,289E+03
51	1,289E+03	1,289E+03
52	1,289E+03	0,000E+00
53	0,000E+00	1,289E+03
54	1,289E+03	1,289E+03
55	1,289E+03	0,000E+00
56	0,000E+00	1,289E+03
57	1,289E+03	1,289E+03
58	1,289E+03	0,000E+00
59	0,000E+00	1,289E+03
60	1,289E+03	1,289E+03
61	1,289E+03	0,000E+00
62	1,289E+03	1,289E+03
63	0,000E+00	1,289E+03
64	1,289E+03	1,289E+03
65	1,289E+03	0,000E+00
66	0,000E+00	1,289E+03
67	1,289E+03	1,289E+03
68	1,289E+03	0,000E+00
69	0,000E+00	1,289E+03
70	1,289E+03	1,289E+03
71	1,289E+03	0,000E+00
72	0,000E+00	1,289E+03
73	1,289E+03	1,289E+03
74	1,289E+03	0,000E+00
75	0,000E+00	1,289E+03
76	1,289E+03	1,289E+03
77	1,289E+03	0,000E+00
78	0,000E+00	1,289E+03
79	1,289E+03	1,289E+03
80	1,289E+03	0,000E+00
81	0,000E+00	1,289E+03
82	1,289E+03	1,289E+03
83	1,289E+03	0,000E+00
84	0,000E+00	1,289E+03
85	1,289E+03	1,289E+03
86	1,289E+03	0,000E+00
87	0,000E+00	1,289E+03
88	1,289E+03	1,289E+03
89	1,289E+03	0,000E+00
90	0,000E+00	1,289E+03
91	1,289E+03	1,289E+03
92	1,289E+03	0,000E+00

93	0,000E+00	1,289E+03
94	1,289E+03	1,289E+03
95	1,289E+03	0,000E+00
96	1,289E+03	1,289E+03
97	0,000E+00	1,289E+03
98	1,289E+03	1,289E+03
99	1,289E+03	0,000E+00
100	0,000E+00	1,289E+03
101	1,289E+03	1,289E+03
102	1,289E+03	0,000E+00
103	0,000E+00	1,289E+03
104	1,289E+03	1,289E+03
105	1,289E+03	0,000E+00
106	0,000E+00	1,289E+03
107	1,289E+03	1,289E+03
108	1,289E+03	0,000E+00
109	0,000E+00	1,289E+03
110	1,289E+03	1,289E+03
111	1,289E+03	0,000E+00
112	0,000E+00	1,289E+03
113	1,289E+03	1,289E+03
114	1,289E+03	0,000E+00
115	0,000E+00	1,289E+03
116	1,289E+03	1,289E+03
117	1,289E+03	0,000E+00
118	0,000E+00	1,289E+03
119	0,000E+00	1,289E+03
120	0,000E+00	0,000E+00

Table 8: HM annual fluxes for UOX enrichment and fabrication plants in the open cycle.

Finally, Table 9 presents the HM inventory within the UOX Spent Fuel (SF) interim storage during the whole cycle.

<b>YEAR</b>	<b>UOX</b>
	tons
-2	0,000E+00
-1	0,000E+00
0	1,289E+03
1	1,289E+03
2	2,578E+03
3	3,867E+03
4	3,867E+03
5	5,156E+03
6	6,445E+03

7	6,445E+03
8	7,734E+03
9	9,023E+03
10	9,023E+03
11	1,031E+04
12	1,160E+04
13	1,160E+04
14	1,289E+04
15	1,418E+04
16	1,418E+04
17	1,547E+04
18	1,676E+04
19	1,676E+04
20	1,805E+04
21	1,933E+04
22	1,933E+04
23	2,062E+04
24	2,191E+04
25	2,191E+04
26	2,320E+04
27	2,449E+04
28	2,578E+04
29	2,578E+04
30	2,707E+04
31	2,836E+04
32	2,836E+04
33	2,965E+04
34	3,094E+04
35	3,094E+04
36	3,222E+04
37	3,351E+04
38	3,351E+04
39	3,480E+04
40	3,609E+04
41	3,609E+04
42	3,738E+04
43	3,867E+04
44	3,867E+04
45	3,996E+04
46	4,125E+04
47	4,125E+04
48	4,254E+04
49	4,383E+04
50	4,383E+04
51	4,511E+04
52	4,640E+04
53	4,640E+04
54	4,769E+04
55	4,898E+04

56	4,898E+04
57	5,027E+04
58	5,156E+04
59	5,285E+04
60	5,285E+04
61	5,414E+04
62	5,543E+04
63	5,543E+04
64	5,672E+04
65	5,800E+04
66	5,800E+04
67	5,929E+04
68	6,058E+04
69	6,058E+04
70	6,187E+04
71	6,316E+04
72	6,316E+04
73	6,445E+04
74	6,574E+04
75	6,574E+04
76	6,703E+04
77	6,832E+04
78	6,832E+04
79	6,961E+04
80	7,089E+04
81	7,089E+04
82	7,218E+04
83	7,347E+04
84	7,347E+04
85	7,476E+04
86	7,605E+04
87	7,605E+04
88	7,734E+04
89	7,863E+04
90	7,863E+04
91	7,992E+04
92	8,121E+04
93	8,250E+04
94	8,250E+04
95	8,379E+04
96	8,507E+04
97	8,507E+04
98	8,636E+04
99	8,765E+04
100	8,765E+04
101	8,894E+04
102	9,023E+04
103	9,023E+04
104	9,152E+04



105	9,281E+04
106	9,281E+04
107	9,410E+04
108	9,539E+04
109	9,539E+04
110	9,668E+04
111	9,796E+04
112	9,796E+04
113	9,925E+04
114	1,005E+05
115	1,005E+05
116	1,018E+05
117	1,031E+05
118	1,031E+05
119	1,044E+05
120	1,057E+05

Table 9: HM inventory for the SF interim storage in the open cycle scenario.

## 5.2.2 Pu monorecycling in PWRs

The second scenario represents a slight evolution of the previous one, with the introduction of several MOX PWRs for the monorecycling of the Plutonium produced in the traditional UOX PWRs. As expected, the NU consumption and, therefore, the enrichment SWUs needed, is a little reduced with respect to the open cycle case, to ensure the same electrical production. Table 10 summarizes the annual NU and SWUs needs.

YEAR	Natural U needs	
	tons/year	SWU/year
-2	1,315E+04	1,007E+07
-1	1,282E+04	9,825E+06
0	1,216E+04	9,319E+06
1	0,000E+00	0,000E+00
2	1,183E+04	9,067E+06
3	1,183E+04	9,067E+06
4	0,000E+00	0,000E+00
5	1,183E+04	9,067E+06
6	1,183E+04	9,067E+06
7	0,000E+00	0,000E+00
8	1,183E+04	9,067E+06
9	1,183E+04	9,067E+06
10	0,000E+00	0,000E+00
11	1,183E+04	9,067E+06
12	1,183E+04	9,067E+06
13	0,000E+00	0,000E+00
14	1,183E+04	9,067E+06
15	1,183E+04	9,067E+06
16	0,000E+00	0,000E+00
17	1,183E+04	9,067E+06
18	1,183E+04	9,067E+06
19	0,000E+00	0,000E+00
20	1,183E+04	9,067E+06
21	1,183E+04	9,067E+06
22	0,000E+00	0,000E+00
23	1,183E+04	9,067E+06
24	1,183E+04	9,067E+06
25	0,000E+00	0,000E+00
26	1,183E+04	9,067E+06
27	1,183E+04	9,067E+06
28	0,000E+00	0,000E+00
29	1,183E+04	9,067E+06
30	1,183E+04	9,067E+06
31	1,183E+04	9,067E+06
32	0,000E+00	0,000E+00
33	1,183E+04	9,067E+06

34	1,183E+04	9,067E+06
35	0,000E+00	0,000E+00
36	1,183E+04	9,067E+06
37	1,183E+04	9,067E+06
38	0,000E+00	0,000E+00
39	1,183E+04	9,067E+06
40	1,183E+04	9,067E+06
41	0,000E+00	0,000E+00
42	1,183E+04	9,067E+06
43	1,183E+04	9,067E+06
44	0,000E+00	0,000E+00
45	1,183E+04	9,067E+06
46	1,183E+04	9,067E+06
47	0,000E+00	0,000E+00
48	1,183E+04	9,067E+06
49	1,183E+04	9,067E+06
50	0,000E+00	0,000E+00
51	1,183E+04	9,067E+06
52	1,183E+04	9,067E+06
53	0,000E+00	0,000E+00
54	1,183E+04	9,067E+06
55	1,183E+04	9,067E+06
56	0,000E+00	0,000E+00
57	1,183E+04	9,067E+06
58	1,183E+04	9,067E+06
59	0,000E+00	0,000E+00
60	1,183E+04	9,067E+06
61	1,183E+04	9,067E+06
62	1,183E+04	9,067E+06
63	0,000E+00	0,000E+00
64	1,183E+04	9,067E+06
65	1,183E+04	9,067E+06
66	0,000E+00	0,000E+00
67	1,183E+04	9,067E+06
68	1,183E+04	9,067E+06
69	0,000E+00	0,000E+00
70	1,183E+04	9,067E+06
71	1,183E+04	9,067E+06
72	0,000E+00	0,000E+00
73	1,183E+04	9,067E+06
74	1,183E+04	9,067E+06
75	0,000E+00	0,000E+00
76	1,183E+04	9,067E+06
77	1,183E+04	9,067E+06
78	0,000E+00	0,000E+00
79	1,183E+04	9,067E+06
80	1,183E+04	9,067E+06
81	0,000E+00	0,000E+00
82	1,183E+04	9,067E+06

83	1,183E+04	9,067E+06
84	0,000E+00	0,000E+00
85	1,183E+04	9,067E+06
86	1,183E+04	9,067E+06
87	0,000E+00	0,000E+00
88	1,183E+04	9,067E+06
89	1,183E+04	9,067E+06
90	0,000E+00	0,000E+00
91	1,183E+04	9,067E+06
92	1,183E+04	9,067E+06
93	0,000E+00	0,000E+00
94	1,183E+04	9,067E+06
95	1,183E+04	9,067E+06
96	1,183E+04	9,067E+06
97	0,000E+00	0,000E+00
98	1,183E+04	9,067E+06
99	1,183E+04	9,067E+06
100	0,000E+00	0,000E+00
101	1,183E+04	9,067E+06
102	1,183E+04	9,067E+06
103	0,000E+00	0,000E+00
104	1,183E+04	9,067E+06
105	1,183E+04	9,067E+06
106	0,000E+00	0,000E+00
107	1,183E+04	9,067E+06
108	1,183E+04	9,067E+06
109	0,000E+00	0,000E+00
110	1,183E+04	9,067E+06
111	1,183E+04	9,067E+06
112	0,000E+00	0,000E+00
113	1,183E+04	9,067E+06
114	1,183E+04	9,067E+06
115	0,000E+00	0,000E+00
116	1,183E+04	9,067E+06
117	1,183E+04	9,067E+06
118	0,000E+00	0,000E+00
119	0,000E+00	0,000E+00
120	0,000E+00	0,000E+00

Table 10: NU and SWUs annual needs for the Pu monorecycling scenario.

The annual fluxes for both the UOX and MOX fabrication plants are collected in Table 11.

YEAR	UOX	MOX
	tons/y	tons/y
-2	0,000E+00	0,000E+00
-1	0,000E+00	0,000E+00
0	1,289E+03	9,668E+01
1	1,257E+03	1,289E+02
2	1,192E+03	9,668E+01
3	0,000E+00	6,445E+01
4	1,160E+03	9,668E+01
5	1,160E+03	9,668E+01
6	0,000E+00	6,445E+01
7	1,160E+03	9,668E+01
8	1,160E+03	9,668E+01
9	0,000E+00	2,326E+01
10	1,160E+03	0,000E+00
11	1,160E+03	9,667E+01
12	0,000E+00	5,642E+01
13	1,160E+03	8,564E+01
14	1,160E+03	9,667E+01
15	0,000E+00	4,741E+01
16	1,160E+03	7,662E+01
17	1,160E+03	9,667E+01
18	0,000E+00	4,440E+01
19	1,160E+03	7,662E+01
20	1,160E+03	9,667E+01
21	0,000E+00	4,440E+01
22	1,160E+03	7,662E+01
23	1,160E+03	9,667E+01
24	0,000E+00	4,440E+01
25	1,160E+03	7,662E+01
26	1,160E+03	9,667E+01
27	0,000E+00	4,440E+01
28	1,160E+03	7,662E+01
29	1,160E+03	9,667E+01
30	0,000E+00	4,440E+01
31	1,160E+03	7,662E+01
32	1,160E+03	1,088E+02
33	1,160E+03	9,667E+01
34	0,000E+00	4,440E+01
35	1,160E+03	7,662E+01
36	1,160E+03	9,668E+01
37	0,000E+00	4,440E+01
38	1,160E+03	7,662E+01
39	1,160E+03	9,668E+01
40	0,000E+00	4,440E+01
41	1,160E+03	7,662E+01
42	1,160E+03	9,667E+01
43	0,000E+00	4,440E+01

	<b>Centro Ricerche Bologna</b>	<b>Sigla di identificazione</b> FPN – P9LU-034	Rev. 0	Distrib. L	Pag. 28	di 60
---	--------------------------------	---	-----------	---------------	------------	----------

44	1,160E+03	7,662E+01
45	1,160E+03	9,668E+01
46	0,000E+00	4,440E+01
47	1,160E+03	7,662E+01
48	1,160E+03	9,667E+01
49	0,000E+00	4,440E+01
50	1,160E+03	7,662E+01
51	1,160E+03	9,667E+01
52	0,000E+00	4,440E+01
53	1,160E+03	7,662E+01
54	1,160E+03	9,667E+01
55	0,000E+00	4,440E+01
56	1,160E+03	7,662E+01
57	1,160E+03	9,667E+01
58	0,000E+00	4,440E+01
59	1,160E+03	7,662E+01
60	1,160E+03	9,667E+01
61	0,000E+00	4,440E+01
62	1,160E+03	7,662E+01
63	1,160E+03	1,088E+02
64	1,160E+03	9,667E+01
65	0,000E+00	4,440E+01
66	1,160E+03	7,662E+01
67	1,160E+03	9,667E+01
68	0,000E+00	4,440E+01
69	1,160E+03	7,662E+01
70	1,160E+03	9,667E+01
71	0,000E+00	4,440E+01
72	1,160E+03	7,662E+01
73	1,160E+03	9,667E+01
74	0,000E+00	4,440E+01
75	1,160E+03	7,662E+01
76	1,160E+03	9,667E+01
77	0,000E+00	4,440E+01
78	1,160E+03	7,662E+01
79	1,160E+03	9,667E+01
80	0,000E+00	4,440E+01
81	1,160E+03	7,662E+01
82	1,160E+03	9,667E+01
83	0,000E+00	4,440E+01
84	1,160E+03	7,662E+01
85	1,160E+03	9,667E+01
86	0,000E+00	4,440E+01
87	1,160E+03	7,662E+01
88	1,160E+03	9,667E+01
89	0,000E+00	4,440E+01
90	1,160E+03	7,662E+01
91	1,160E+03	9,667E+01
92	0,000E+00	4,440E+01

93	1,160E+03	7,662E+01
94	1,160E+03	9,667E+01
95	0,000E+00	4,440E+01
96	1,160E+03	7,662E+01
97	1,160E+03	1,088E+02
98	1,160E+03	9,667E+01
99	0,000E+00	4,440E+01
100	1,160E+03	7,662E+01
101	1,160E+03	9,667E+01
102	0,000E+00	4,440E+01
103	1,160E+03	7,662E+01
104	1,160E+03	9,667E+01
105	0,000E+00	4,440E+01
106	1,160E+03	7,662E+01
107	1,160E+03	9,667E+01
108	0,000E+00	4,440E+01
109	1,160E+03	7,662E+01
110	1,160E+03	9,667E+01
111	0,000E+00	4,440E+01
112	1,160E+03	7,662E+01
113	1,160E+03	9,667E+01
114	0,000E+00	4,440E+01
115	1,160E+03	7,662E+01
116	1,160E+03	9,667E+01
117	0,000E+00	4,440E+01
118	1,160E+03	0,000E+00
119	1,160E+03	0,000E+00
120	0,000E+00	0,000E+00

Table 11: Fabricated UOX and MOX annual fluxes for the Pu monorecycling scenario.

The corresponding irradiated UOX and MOX fuel inventories are summarized in Table 12 referring to the status of the respective SF interim storages.

YEAR	UOX	MOX
	tons	tons
-2	1,000E+04	0,000E+00
-1	1,000E+04	0,000E+00
0	1,129E+04	0,000E+00
1	1,129E+04	0,000E+00
2	1,255E+04	6,445E+01
3	1,374E+04	1,289E+02
4	1,374E+04	2,256E+02
5	1,490E+04	3,223E+02
6	1,606E+04	3,867E+02

	Centro Ricerche Bologna	<b>Sigla di identificazione</b>	Rev.	Distrib.	Pag.	di
		FPN – P9LU-034	0	L	30	60

7	1,606E+04	4,834E+02
8	1,722E+04	5,801E+02
9	1,838E+04	6,445E+02
10	1,838E+04	7,412E+02
11	1,954E+04	8,379E+02
12	2,070E+04	8,611E+02
13	2,070E+04	8,611E+02
14	2,186E+04	9,578E+02
15	2,302E+04	1,014E+03
16	2,302E+04	1,100E+03
17	2,418E+04	1,197E+03
18	2,534E+04	1,244E+03
19	2,534E+04	1,321E+03
20	2,650E+04	1,417E+03
21	2,766E+04	1,462E+03
22	2,766E+04	1,538E+03
23	2,882E+04	1,635E+03
24	2,998E+04	1,679E+03
25	2,998E+04	1,756E+03
26	3,114E+04	1,853E+03
27	3,230E+04	1,897E+03
28	3,346E+04	1,974E+03
29	3,346E+04	2,083E+03
30	3,462E+04	2,179E+03
31	3,578E+04	2,224E+03
32	3,578E+04	2,300E+03
33	3,694E+04	2,397E+03
34	3,810E+04	2,441E+03
35	3,810E+04	2,518E+03
36	3,926E+04	2,615E+03
37	4,042E+04	2,659E+03
38	4,042E+04	2,736E+03
39	4,158E+04	2,832E+03
40	4,274E+04	2,877E+03
41	4,274E+04	2,953E+03
42	4,390E+04	3,050E+03
43	4,506E+04	3,094E+03
44	4,506E+04	3,171E+03
45	4,622E+04	3,268E+03
46	4,738E+04	3,312E+03
47	4,738E+04	3,389E+03
48	4,854E+04	3,485E+03
49	4,970E+04	3,530E+03
50	4,970E+04	3,606E+03
51	5,086E+04	3,703E+03
52	5,202E+04	3,747E+03
53	5,202E+04	3,824E+03
54	5,318E+04	3,921E+03
55	5,434E+04	3,965E+03



56	5,434E+04	4,042E+03
57	5,550E+04	4,138E+03
58	5,666E+04	4,183E+03
59	5,782E+04	4,260E+03
60	5,782E+04	4,368E+03
61	5,898E+04	4,465E+03
62	6,014E+04	4,509E+03
63	6,014E+04	4,586E+03
64	6,130E+04	4,683E+03
65	6,246E+04	4,727E+03
66	6,246E+04	4,804E+03
67	6,362E+04	4,900E+03
68	6,478E+04	4,945E+03
69	6,478E+04	5,021E+03
70	6,594E+04	5,118E+03
71	6,710E+04	5,163E+03
72	6,710E+04	5,239E+03
73	6,826E+04	5,336E+03
74	6,942E+04	5,380E+03
75	6,942E+04	5,457E+03
76	7,058E+04	5,554E+03
77	7,174E+04	5,598E+03
78	7,174E+04	5,675E+03
79	7,290E+04	5,771E+03
80	7,406E+04	5,816E+03
81	7,406E+04	5,892E+03
82	7,522E+04	5,989E+03
83	7,638E+04	6,033E+03
84	7,638E+04	6,110E+03
85	7,754E+04	6,207E+03
86	7,870E+04	6,251E+03
87	7,870E+04	6,328E+03
88	7,986E+04	6,424E+03
89	8,102E+04	6,469E+03
90	8,102E+04	6,545E+03
91	8,218E+04	6,642E+03
92	8,334E+04	6,686E+03
93	8,450E+04	6,763E+03
94	8,450E+04	6,872E+03
95	8,566E+04	6,969E+03
96	8,682E+04	7,013E+03
97	8,682E+04	7,090E+03
98	8,798E+04	7,186E+03
99	8,914E+04	7,231E+03
100	8,914E+04	7,307E+03
101	9,030E+04	7,404E+03
102	9,146E+04	7,448E+03
103	9,146E+04	7,525E+03
104	9,262E+04	7,622E+03

105	9,378E+04	7,666E+03
106	9,378E+04	7,743E+03
107	9,495E+04	7,839E+03
108	9,611E+04	7,884E+03
109	9,611E+04	7,960E+03
110	9,727E+04	8,057E+03
111	9,843E+04	8,101E+03
112	9,843E+04	8,178E+03
113	9,959E+04	8,275E+03
114	1,007E+05	8,319E+03
115	1,007E+05	8,396E+03
116	1,019E+05	8,492E+03
117	1,031E+05	8,537E+03
118	1,031E+05	8,613E+03
119	1,042E+05	8,710E+03
120	1,054E+05	8,755E+03

Table 12: Spent UOX and MOX fuel inventories generated during the Pu monorecycling scenario.

In particular, the annual fluxes for the Pu monorecycling are presented in Table 13 in terms of spent UOX masses incoming into the reprocessing plant and the corresponding recycled Pu masses produced.

YEAR	UOX	Pu
	tons/y	tons/y
-2	0,000E+00	0,000E+00
-1	0,000E+00	0,000E+00
0	1,076E+03	1,359E+01
1	1,454E+03	1,823E+01
2	1,105E+03	1,375E+01
3	7,429E+02	9,205E+00
4	1,124E+03	1,386E+01
5	1,135E+03	1,393E+01
6	7,630E+02	9,323E+00
7	1,153E+03	1,403E+01
8	1,165E+03	1,410E+01
9	2,817E+02	3,403E+00
10	0,000E+00	0,000E+00
11	1,030E+03	1,340E+01
12	6,015E+02	7,827E+00
13	9,147E+02	1,189E+01
14	1,030E+03	1,340E+01
15	5,048E+02	6,573E+00
16	8,180E+02	1,063E+01

	Centro Ricerche Bologna	<b>Sigla di identificazione</b>	Rev.	Distrib.	Pag.	di
		FPN – P9LU-034	0	L	33	60

17	1,030E+03	1,340E+01
18	4,726E+02	6,155E+00
19	8,180E+02	1,063E+01
20	1,030E+03	1,340E+01
21	4,726E+02	6,155E+00
22	8,180E+02	1,063E+01
23	1,030E+03	1,340E+01
24	4,726E+02	6,155E+00
25	8,180E+02	1,063E+01
26	1,030E+03	1,340E+01
27	4,726E+02	6,155E+00
28	8,180E+02	1,063E+01
29	1,030E+03	1,340E+01
30	4,726E+02	6,155E+00
31	8,180E+02	1,063E+01
32	1,160E+03	1,510E+01
33	1,030E+03	1,340E+01
34	4,726E+02	6,155E+00
35	8,180E+02	1,063E+01
36	1,030E+03	1,340E+01
37	4,726E+02	6,155E+00
38	8,180E+02	1,063E+01
39	1,030E+03	1,340E+01
40	4,726E+02	6,155E+00
41	8,180E+02	1,063E+01
42	1,030E+03	1,340E+01
43	4,726E+02	6,155E+00
44	8,180E+02	1,063E+01
45	1,030E+03	1,340E+01
46	4,726E+02	6,155E+00
47	8,180E+02	1,063E+01
48	1,030E+03	1,340E+01
49	4,726E+02	6,155E+00
50	8,180E+02	1,063E+01
51	1,030E+03	1,340E+01
52	4,726E+02	6,155E+00
53	8,180E+02	1,063E+01
54	1,030E+03	1,340E+01
55	4,726E+02	6,155E+00
56	8,180E+02	1,063E+01
57	1,030E+03	1,340E+01
58	4,726E+02	6,155E+00
59	8,180E+02	1,063E+01
60	1,030E+03	1,340E+01
61	4,726E+02	6,155E+00
62	8,180E+02	1,063E+01
63	1,160E+03	1,510E+01
64	1,030E+03	1,340E+01
65	4,726E+02	6,155E+00

	<b>Centro Ricerche Bologna</b>	<b>Sigla di identificazione</b> FPN – P9LU-034	Rev. 0	Distrib. L	Pag. 34	di 60
---	--------------------------------	---	-----------	---------------	------------	----------

66	8,180E+02	1,063E+01
67	1,030E+03	1,340E+01
68	4,726E+02	6,155E+00
69	8,180E+02	1,063E+01
70	1,030E+03	1,340E+01
71	4,726E+02	6,155E+00
72	8,180E+02	1,063E+01
73	1,030E+03	1,340E+01
74	4,726E+02	6,155E+00
75	8,180E+02	1,063E+01
76	1,030E+03	1,340E+01
77	4,726E+02	6,155E+00
78	8,180E+02	1,063E+01
79	1,030E+03	1,340E+01
80	4,726E+02	6,155E+00
81	8,180E+02	1,063E+01
82	1,030E+03	1,340E+01
83	4,726E+02	6,155E+00
84	8,180E+02	1,063E+01
85	1,030E+03	1,340E+01
86	4,726E+02	6,155E+00
87	8,180E+02	1,063E+01
88	1,030E+03	1,340E+01
89	4,726E+02	6,155E+00
90	8,180E+02	1,063E+01
91	1,030E+03	1,340E+01
92	4,726E+02	6,155E+00
93	8,180E+02	1,063E+01
94	1,030E+03	1,340E+01
95	4,726E+02	6,155E+00
96	8,180E+02	1,063E+01
97	1,160E+03	1,510E+01
98	1,030E+03	1,340E+01
99	4,726E+02	6,155E+00
100	8,180E+02	1,063E+01
101	1,030E+03	1,340E+01
102	4,726E+02	6,155E+00
103	8,180E+02	1,063E+01
104	1,030E+03	1,340E+01
105	4,726E+02	6,155E+00
106	8,180E+02	1,063E+01
107	1,030E+03	1,340E+01
108	4,726E+02	6,155E+00
109	8,180E+02	1,063E+01
110	1,030E+03	1,340E+01
111	4,726E+02	6,155E+00
112	8,180E+02	1,063E+01
113	1,030E+03	1,340E+01
114	4,726E+02	6,155E+00

115	8,180E+02	1,063E+01
116	1,030E+03	1,340E+01
117	4,726E+02	6,155E+00
118	0,000E+00	0,000E+00
119	0,000E+00	0,000E+00
120	0,000E+00	0,000E+00

Table 13: Reprocessed UOX and recycled Pu annual fluxes for the Pu monorecycling scenario.

Finally, the chemical composition of the wastes (Pu and MAs from reprocessing and treatment losses, together with Fission Products, FPs), the reprocessed U inventory and the U losses are shown in Tables 14-15.

YEAR	Pu losses	Am losses	Np losses	Cm losses	Waste (FP)
	tons	tons	tons	tons	tons
-2	0,000E+00	0,000E+00	0,000E+00	0,000E+00	0,000E+00
-1	0,000E+00	0,000E+00	0,000E+00	0,000E+00	0,000E+00
0	1,359E-02	8,737E-01	9,864E-01	1,427E-01	6,663E+01
1	3,183E-02	1,846E+00	1,986E+00	2,773E-01	1,340E+02
2	4,558E-02	2,541E+00	2,661E+00	3,586E-01	1,794E+02
3	5,478E-02	3,658E+00	3,683E+00	4,791E-01	2,480E+02
4	6,865E-02	4,864E+00	4,718E+00	5,925E-01	3,173E+02
5	8,258E-02	5,710E+00	5,418E+00	6,568E-01	3,640E+02
6	9,190E-02	7,048E+00	6,476E+00	7,579E-01	4,344E+02
7	1,059E-01	8,466E+00	7,547E+00	8,529E-01	5,056E+02
8	1,200E-01	9,449E+00	8,273E+00	9,028E-01	5,535E+02
9	1,235E-01	1,084E+01	9,267E+00	9,765E-01	6,190E+02
10	1,235E-01	1,083E+01	9,279E+00	9,446E-01	6,190E+02
11	1,369E-01	1,114E+01	9,607E+00	9,678E-01	6,378E+02
12	1,447E-01	1,205E+01	1,049E+01	1,081E+00	6,897E+02
13	1,566E-01	1,303E+01	1,145E+01	1,205E+00	7,462E+02
14	1,700E-01	1,357E+01	1,199E+01	1,253E+00	7,774E+02
15	1,765E-01	1,438E+01	1,279E+01	1,342E+00	8,240E+02
16	1,872E-01	1,536E+01	1,376E+01	1,458E+00	8,805E+02
17	2,006E-01	1,579E+01	1,421E+01	1,483E+00	9,064E+02
18	2,067E-01	1,658E+01	1,498E+01	1,560E+00	9,513E+02
19	2,174E-01	1,755E+01	1,595E+01	1,668E+00	1,008E+03
20	2,308E-01	1,798E+01	1,640E+01	1,687E+00	1,034E+03
21	2,369E-01	1,876E+01	1,718E+01	1,757E+00	1,079E+03
22	2,476E-01	1,973E+01	1,814E+01	1,859E+00	1,135E+03
23	2,610E-01	2,016E+01	1,860E+01	1,872E+00	1,161E+03
24	2,671E-01	2,094E+01	1,938E+01	1,936E+00	1,206E+03
25	2,778E-01	2,191E+01	2,035E+01	2,033E+00	1,262E+03
26	2,912E-01	2,233E+01	2,081E+01	2,041E+00	1,288E+03

	Centro Ricerche Bologna	Sigla di identificazione	Rev.	Distrib.	Pag.	di
		FPN – P9LU-034	0	L	36	60

27	2,973E-01	2,311E+01	2,158E+01	2,099E+00	1,333E+03
28	3,080E-01	2,407E+01	2,256E+01	2,191E+00	1,389E+03
29	3,214E-01	2,450E+01	2,302E+01	2,194E+00	1,415E+03
30	3,275E-01	2,527E+01	2,380E+01	2,248E+00	1,460E+03
31	3,382E-01	2,637E+01	2,489E+01	2,355E+00	1,524E+03
32	3,533E-01	2,733E+01	2,587E+01	2,441E+00	1,580E+03
33	3,667E-01	2,775E+01	2,633E+01	2,438E+00	1,606E+03
34	3,728E-01	2,852E+01	2,712E+01	2,487E+00	1,651E+03
35	3,835E-01	2,948E+01	2,809E+01	2,569E+00	1,708E+03
36	3,969E-01	2,991E+01	2,856E+01	2,562E+00	1,734E+03
37	4,030E-01	3,067E+01	2,934E+01	2,608E+00	1,778E+03
38	4,136E-01	3,163E+01	3,032E+01	2,686E+00	1,835E+03
39	4,271E-01	3,205E+01	3,079E+01	2,677E+00	1,861E+03
40	4,332E-01	3,282E+01	3,158E+01	2,718E+00	1,906E+03
41	4,438E-01	3,377E+01	3,256E+01	2,794E+00	1,962E+03
42	4,572E-01	3,419E+01	3,303E+01	2,781E+00	1,988E+03
43	4,634E-01	3,495E+01	3,382E+01	2,821E+00	2,033E+03
44	4,740E-01	3,591E+01	3,480E+01	2,894E+00	2,089E+03
45	4,874E-01	3,632E+01	3,528E+01	2,878E+00	2,115E+03
46	4,936E-01	3,708E+01	3,607E+01	2,915E+00	2,160E+03
47	5,042E-01	3,803E+01	3,705E+01	2,985E+00	2,216E+03
48	5,176E-01	3,845E+01	3,753E+01	2,968E+00	2,241E+03
49	5,238E-01	3,921E+01	3,832E+01	3,002E+00	2,286E+03
50	5,344E-01	4,016E+01	3,931E+01	3,071E+00	2,341E+03
51	5,478E-01	4,057E+01	3,978E+01	3,051E+00	2,367E+03
52	5,540E-01	4,132E+01	4,058E+01	3,084E+00	2,411E+03
53	5,646E-01	4,227E+01	4,157E+01	3,150E+00	2,467E+03
54	5,780E-01	4,268E+01	4,205E+01	3,129E+00	2,493E+03
55	5,842E-01	4,343E+01	4,285E+01	3,159E+00	2,537E+03
56	5,948E-01	4,438E+01	4,384E+01	3,224E+00	2,593E+03
57	6,082E-01	4,478E+01	4,432E+01	3,201E+00	2,618E+03
58	6,144E-01	4,554E+01	4,512E+01	3,230E+00	2,663E+03
59	6,250E-01	4,648E+01	4,611E+01	3,293E+00	2,718E+03
60	6,384E-01	4,688E+01	4,659E+01	3,269E+00	2,744E+03
61	6,446E-01	4,764E+01	4,740E+01	3,296E+00	2,788E+03
62	6,552E-01	4,858E+01	4,839E+01	3,358E+00	2,844E+03
63	6,703E-01	4,898E+01	4,888E+01	3,332E+00	2,869E+03
64	6,837E-01	4,973E+01	4,968E+01	3,358E+00	2,914E+03
65	6,899E-01	5,080E+01	5,080E+01	3,439E+00	2,977E+03
66	7,005E-01	5,173E+01	5,180E+01	3,499E+00	3,032E+03
67	7,139E-01	5,213E+01	5,228E+01	3,471E+00	3,058E+03
68	7,201E-01	5,288E+01	5,309E+01	3,496E+00	3,102E+03
69	7,307E-01	5,382E+01	5,409E+01	3,556E+00	3,158E+03
70	7,441E-01	5,421E+01	5,458E+01	3,527E+00	3,184E+03
71	7,503E-01	5,496E+01	5,539E+01	3,551E+00	3,228E+03
72	7,609E-01	5,589E+01	5,639E+01	3,609E+00	3,284E+03
73	7,743E-01	5,628E+01	5,688E+01	3,580E+00	3,309E+03
74	7,804E-01	5,703E+01	5,769E+01	3,603E+00	3,353E+03
75	7,911E-01	5,796E+01	5,870E+01	3,660E+00	3,409E+03

76	8,045E-01	5,835E+01	5,919E+01	3,630E+00	3,435E+03
77	8,106E-01	5,909E+01	6,000E+01	3,652E+00	3,479E+03
78	8,213E-01	6,002E+01	6,101E+01	3,709E+00	3,535E+03
79	8,347E-01	6,041E+01	6,150E+01	3,678E+00	3,560E+03
80	8,408E-01	6,115E+01	6,232E+01	3,700E+00	3,605E+03
81	8,515E-01	6,208E+01	6,333E+01	3,756E+00	3,660E+03
82	8,649E-01	6,247E+01	6,382E+01	3,724E+00	3,686E+03
83	8,710E-01	6,320E+01	6,464E+01	3,745E+00	3,730E+03
84	8,817E-01	6,413E+01	6,565E+01	3,801E+00	3,786E+03
85	8,951E-01	6,451E+01	6,615E+01	3,769E+00	3,812E+03
86	9,012E-01	6,525E+01	6,697E+01	3,789E+00	3,856E+03
87	9,119E-01	6,617E+01	6,798E+01	3,844E+00	3,912E+03
88	9,253E-01	6,656E+01	6,848E+01	3,811E+00	3,937E+03
89	9,314E-01	6,729E+01	6,930E+01	3,831E+00	3,981E+03
90	9,421E-01	6,821E+01	7,031E+01	3,886E+00	4,037E+03
91	9,555E-01	6,859E+01	7,082E+01	3,853E+00	4,063E+03
92	9,616E-01	6,932E+01	7,164E+01	3,872E+00	4,107E+03
93	9,723E-01	7,024E+01	7,265E+01	3,926E+00	4,163E+03
94	9,857E-01	7,062E+01	7,316E+01	3,893E+00	4,188E+03
95	9,918E-01	7,135E+01	7,398E+01	3,912E+00	4,233E+03
96	1,002E+00	7,240E+01	7,512E+01	3,985E+00	4,295E+03
97	1,018E+00	7,331E+01	7,614E+01	4,039E+00	4,351E+03
98	1,031E+00	7,369E+01	7,665E+01	4,005E+00	4,377E+03
99	1,037E+00	7,442E+01	7,747E+01	4,024E+00	4,421E+03
100	1,048E+00	7,533E+01	7,849E+01	4,077E+00	4,477E+03
101	1,061E+00	7,571E+01	7,900E+01	4,043E+00	4,502E+03
102	1,067E+00	7,643E+01	7,983E+01	4,061E+00	4,547E+03
103	1,078E+00	7,734E+01	8,085E+01	4,114E+00	4,602E+03
104	1,091E+00	7,772E+01	8,137E+01	4,079E+00	4,628E+03
105	1,097E+00	7,844E+01	8,220E+01	4,097E+00	4,672E+03
106	1,108E+00	7,935E+01	8,322E+01	4,150E+00	4,728E+03
107	1,122E+00	7,972E+01	8,373E+01	4,115E+00	4,754E+03
108	1,128E+00	8,044E+01	8,456E+01	4,133E+00	4,798E+03
109	1,138E+00	8,135E+01	8,559E+01	4,186E+00	4,854E+03
110	1,152E+00	8,172E+01	8,611E+01	4,151E+00	4,879E+03
111	1,158E+00	8,244E+01	8,694E+01	4,168E+00	4,924E+03
112	1,169E+00	8,334E+01	8,797E+01	4,220E+00	4,979E+03
113	1,182E+00	8,371E+01	8,848E+01	4,185E+00	5,005E+03
114	1,188E+00	8,443E+01	8,932E+01	4,203E+00	5,049E+03
115	1,199E+00	8,533E+01	9,035E+01	4,255E+00	5,105E+03
116	1,212E+00	8,570E+01	9,087E+01	4,220E+00	5,130E+03
117	1,218E+00	8,641E+01	9,171E+01	4,237E+00	5,175E+03
118		8,665E+01	9,210E+01	4,183E+00	5,193E+03
119		8,656E+01	9,219E+01	4,078E+00	
120		8,647E+01	9,227E+01	3,977E+00	

Table 14: Wastes inventory for Pu, MAs and FPs produced by the Pu monorecycling scenario evolution.



YEAR	Rep. U inventory	U losses
	tons	tons
-2	0,000E+00	0,000E+00
-1	0,000E+00	0,000E+00
0	9,941E+02	2,680E-06
1	2,337E+03	5,410E-06
2	3,358E+03	7,311E-06
3	4,044E+03	1,010E-05
4	5,082E+03	1,289E-05
5	6,131E+03	1,485E-05
6	6,835E+03	1,766E-05
7	7,900E+03	2,048E-05
8	8,976E+03	2,250E-05
9	9,236E+03	2,513E-05
10	9,236E+03	2,563E-05
11	1,019E+04	2,672E-05
12	1,074E+04	2,884E-05
13	1,159E+04	3,117E-05
14	1,254E+04	3,283E-05
15	1,300E+04	3,503E-05
16	1,376E+04	3,760E-05
17	1,471E+04	3,934E-05
18	1,515E+04	4,171E-05
19	1,590E+04	4,452E-05
20	1,685E+04	4,649E-05
21	1,729E+04	4,911E-05
22	1,804E+04	5,216E-05
23	1,899E+04	5,437E-05
24	1,943E+04	5,724E-05
25	2,018E+04	6,053E-05
26	2,113E+04	6,300E-05
27	2,157E+04	6,611E-05
28	2,233E+04	6,966E-05
29	2,328E+04	7,238E-05
30	2,371E+04	7,575E-05
31	2,447E+04	7,977E-05
32	2,554E+04	8,367E-05
33	2,649E+04	8,674E-05
34	2,693E+04	9,046E-05
35	2,768E+04	9,463E-05
36	2,863E+04	9,797E-05
37	2,907E+04	1,020E-04
38	2,982E+04	1,064E-04
39	3,077E+04	1,100E-04
40	3,121E+04	1,143E-04
41	3,197E+04	1,190E-04
42	3,292E+04	1,229E-04
43	3,335E+04	1,274E-04



44	3,411E+04	1,324E-04
45	3,506E+04	1,366E-04
46	3,549E+04	1,415E-04
47	3,625E+04	1,468E-04
48	3,720E+04	1,512E-04
49	3,764E+04	1,564E-04
50	3,839E+04	1,620E-04
51	3,934E+04	1,667E-04
52	3,978E+04	1,722E-04
53	4,053E+04	1,780E-04
54	4,148E+04	1,831E-04
55	4,192E+04	1,889E-04
56	4,268E+04	1,951E-04
57	4,363E+04	2,004E-04
58	4,406E+04	2,065E-04
59	4,482E+04	2,130E-04
60	4,577E+04	2,187E-04
61	4,620E+04	2,250E-04
62	4,696E+04	2,319E-04
63	4,803E+04	2,379E-04
64	4,898E+04	2,446E-04
65	4,942E+04	2,519E-04
66	5,017E+04	2,592E-04
67	5,112E+04	2,656E-04
68	5,156E+04	2,728E-04
69	5,231E+04	2,803E-04
70	5,326E+04	2,871E-04
71	5,370E+04	2,946E-04
72	5,446E+04	3,025E-04
73	5,541E+04	3,096E-04
74	5,584E+04	3,174E-04
75	5,660E+04	3,257E-04
76	5,755E+04	3,331E-04
77	5,799E+04	3,413E-04
78	5,874E+04	3,499E-04
79	5,969E+04	3,577E-04
80	6,013E+04	3,662E-04
81	6,088E+04	3,752E-04
82	6,183E+04	3,833E-04
83	6,227E+04	3,922E-04
84	6,302E+04	4,015E-04
85	6,397E+04	4,100E-04
86	6,441E+04	4,192E-04
87	6,517E+04	4,289E-04
88	6,612E+04	4,378E-04
89	6,655E+04	4,474E-04
90	6,731E+04	4,574E-04
91	6,826E+04	4,667E-04
92	6,870E+04	4,766E-04

93	6,945E+04	4,870E-04
94	7,040E+04	4,967E-04
95	7,084E+04	5,070E-04
96	7,159E+04	5,180E-04
97	7,266E+04	5,289E-04
98	7,361E+04	5,391E-04
99	7,405E+04	5,499E-04
100	7,481E+04	5,612E-04
101	7,576E+04	5,717E-04
102	7,619E+04	5,830E-04
103	7,695E+04	5,947E-04
104	7,790E+04	6,056E-04
105	7,833E+04	6,172E-04
106	7,909E+04	6,293E-04
107	8,004E+04	6,406E-04
108	8,048E+04	6,527E-04
109	8,123E+04	6,652E-04
110	8,218E+04	6,769E-04
111	8,262E+04	6,893E-04
112	8,337E+04	7,022E-04
113	8,432E+04	7,144E-04
114	8,476E+04	7,272E-04
115	8,552E+04	7,405E-04
116	8,647E+04	7,531E-04
117	8,690E+04	7,663E-04
118		7,790E-04
119		
120		

Table 15: Reprocessed and lost U during the Pu monorecycling scenario.

### 5.2.3 Pu monorecycling towards Pu+MAs recycling in FRs

The third scenario is a futuristic hypothesis of full recycling of both Pu and MAs by means of Gen-IV FRs. Such hypothesis permits the elimination of NU need at regime, requiring only Depleted Uranium (DU) and a Pu+MAs mixture to grant the same electrical production assumed as reference for all the three cases. Table 16 reports both the annual NU and SWUs needs, clearly showing the reduction of NU mine sampling towards the independence from NU.

YEAR	Natural U needs	
	tons/year	SWU/year
-2	1,315E+04	1,007E+07
-1	1,282E+04	9,825E+06
0	1,216E+04	9,319E+00
1	0,000E+00	0,000E+00
2	1,183E+04	9,067E+00
3	1,183E+04	9,067E+00
4	0,000E+00	0,000E+00
5	1,183E+04	9,067E+00
6	1,183E+04	9,067E+00
7	0,000E+00	0,000E+00
8	1,183E+04	9,067E+00
9	1,183E+04	9,067E+00
10	0,000E+00	0,000E+00
11	1,183E+04	9,067E+00
12	1,183E+04	9,067E+00
13	0,000E+00	0,000E+00
14	1,183E+04	9,067E+00
15	1,183E+04	9,067E+00
16	0,000E+00	0,000E+00
17	1,183E+04	9,067E+00
18	1,183E+04	9,067E+00
19	0,000E+00	0,000E+00
20	1,183E+04	9,067E+00
21	1,183E+04	9,067E+00
22	0,000E+00	0,000E+00
23	1,183E+04	9,067E+00
24	1,183E+04	9,067E+00
25	0,000E+00	0,000E+00
26	1,183E+04	9,067E+00
27	1,183E+04	9,067E+00
28	0,000E+00	0,000E+00
29	1,183E+04	9,067E+00
30	1,183E+04	9,067E+00
31	1,183E+04	9,067E+00
32	0,000E+00	0,000E+00
33	1,183E+04	9,067E+00

	Centro Ricerche Bologna	<b>Sigla di identificazione</b>	Rev.	Distrib.	Pag.	di
		FPN – P9LU-034	0	L	42	60

34	1,183E+04	9,067E+00
35	0,000E+00	0,000E+00
36	1,183E+04	9,067E+00
37	1,183E+04	9,067E+00
38	0,000E+00	0,000E+00
39	1,183E+04	9,067E+00
40	1,183E+04	9,067E+00
41	0,000E+00	0,000E+00
42	1,183E+04	9,067E+00
43	1,183E+04	9,067E+00
44	0,000E+00	0,000E+00
45	1,183E+04	9,067E+00
46	1,183E+04	9,067E+00
47	0,000E+00	0,000E+00
48	1,183E+04	9,067E+00
49	1,183E+04	9,067E+00
50	0,000E+00	0,000E+00
51	1,183E+04	9,067E+00
52	1,183E+04	9,067E+00
53	0,000E+00	0,000E+00
54	1,183E+04	9,067E+00
55	1,183E+04	9,067E+00
56	0,000E+00	0,000E+00
57	1,183E+04	9,067E+00
58	1,183E+04	9,067E+00
59	0,000E+00	0,000E+00
60	1,183E+04	9,067E+00
61	1,183E+04	9,067E+00
62	1,183E+04	9,067E+00
63	0,000E+00	0,000E+00
64	1,183E+04	9,067E+00
65	1,183E+04	9,067E+00
66	0,000E+00	0,000E+00
67	1,183E+04	9,067E+00
68	1,183E+04	9,067E+00
69	3,287E+02	2,519E-01
70	1,282E+04	9,823E+00
71	1,315E+04	1,007E+01
72	9,862E+02	7,556E-01
73	1,249E+04	9,571E+00
74	1,282E+04	9,823E+00
75	9,862E+02	7,556E-01
76	1,249E+04	9,571E+00
77	1,282E+04	9,823E+00
78	9,862E+02	7,556E-01
79	1,216E+04	9,319E+00
80	1,183E+04	9,067E+00
81	9,862E+02	7,556E-01
82	1,085E+04	8,312E+00

83	1,052E+04	8,060E+00
84	9,862E+02	7,556E-01
85	9,533E+03	7,304E+00
86	9,204E+03	7,052E+00
87	9,862E+02	7,556E-01
88	8,218E+03	6,297E+00
89	7,889E+03	6,045E+00
90	9,862E+02	7,556E-01
91	6,903E+03	5,289E+00
92	6,575E+03	5,037E+00
93	9,862E+02	7,556E-01
94	5,588E+03	4,282E+00
95	5,260E+03	4,030E+00
96	4,931E+03	3,778E+00
97	6,575E+02	5,037E-01
98	3,945E+03	3,022E+00
99	3,616E+03	2,771E+00
100	6,575E+02	5,037E-01
101	2,630E+03	2,015E+00
102	2,630E+03	2,015E+00
103	9,862E+02	7,556E-01
104	9,862E+02	7,556E-01
105	9,862E+02	7,556E-01
106	9,862E+02	7,556E-01
107	3,287E+02	2,519E-01
108	0,000E+00	0,000E+00
109	0,000E+00	0,000E+00
110	0,000E+00	0,000E+00
111	0,000E+00	0,000E+00
112	0,000E+00	0,000E+00
113	0,000E+00	0,000E+00
114	0,000E+00	0,000E+00
115	0,000E+00	0,000E+00
116	0,000E+00	0,000E+00
117	0,000E+00	0,000E+00
118	0,000E+00	0,000E+00
119	0,000E+00	0,000E+00
120	0,000E+00	0,000E+00

Table 16: NU and SWUs annual needs for the third scenario.

The annual fluxes for the PWRs UOX and MOX, and for the FRs MOX fuel and UOX blankets fabrication plants are collected in Table 17.

<b>YEAR</b>	<b>UOX</b>	<b>MOX</b>	<b>FR Fuel</b>	<b>FR Blankets</b>
	tons/y	tons/y	tons/y	tons/y
-2	0,000E+00	0,000E+00	0,000E+00	0,000E+00
-1	0,000E+00	0,000E+00	0,000E+00	0,000E+00
0	1,289E+03	0,000E+00	0,000E+00	0,000E+00
1	1,257E+03	3,223E+01	0,000E+00	0,000E+00
2	1,192E+03	9,668E+01	0,000E+00	0,000E+00
3	0,000E+00	1,289E+02	0,000E+00	0,000E+00
4	1,160E+03	9,667E+01	0,000E+00	0,000E+00
5	1,160E+03	6,445E+01	0,000E+00	0,000E+00
6	0,000E+00	9,668E+01	0,000E+00	0,000E+00
7	1,160E+03	9,668E+01	0,000E+00	0,000E+00
8	1,160E+03	6,445E+01	0,000E+00	0,000E+00
9	0,000E+00	9,668E+01	0,000E+00	0,000E+00
10	1,160E+03	9,668E+01	0,000E+00	0,000E+00
11	1,160E+03	6,445E+01	0,000E+00	0,000E+00
12	0,000E+00	9,668E+01	0,000E+00	0,000E+00
13	1,160E+03	9,667E+01	0,000E+00	0,000E+00
14	1,160E+03	6,445E+01	0,000E+00	0,000E+00
15	0,000E+00	9,667E+01	0,000E+00	0,000E+00
16	1,160E+03	9,668E+01	0,000E+00	0,000E+00
17	1,160E+03	6,445E+01	0,000E+00	0,000E+00
18	0,000E+00	9,668E+01	0,000E+00	0,000E+00
19	1,160E+03	9,667E+01	0,000E+00	0,000E+00
20	1,160E+03	6,445E+01	0,000E+00	0,000E+00
21	0,000E+00	9,668E+01	0,000E+00	0,000E+00
22	1,160E+03	9,668E+01	0,000E+00	0,000E+00
23	1,160E+03	6,445E+01	0,000E+00	0,000E+00
24	0,000E+00	9,668E+01	0,000E+00	0,000E+00
25	1,160E+03	9,667E+01	0,000E+00	0,000E+00
26	1,160E+03	6,445E+01	0,000E+00	0,000E+00
27	0,000E+00	9,668E+01	0,000E+00	0,000E+00
28	1,160E+03	9,668E+01	0,000E+00	0,000E+00
29	1,160E+03	6,445E+01	0,000E+00	0,000E+00
30	0,000E+00	9,668E+01	0,000E+00	0,000E+00
31	1,160E+03	9,668E+01	0,000E+00	0,000E+00
32	1,160E+03	6,445E+01	0,000E+00	0,000E+00
33	1,160E+03	9,668E+01	0,000E+00	0,000E+00
34	0,000E+00	1,289E+02	0,000E+00	0,000E+00
35	1,160E+03	9,667E+01	0,000E+00	0,000E+00
36	1,160E+03	6,445E+01	0,000E+00	0,000E+00
37	0,000E+00	9,668E+01	0,000E+00	0,000E+00
38	1,160E+03	9,667E+01	0,000E+00	0,000E+00
39	1,160E+03	6,445E+01	0,000E+00	0,000E+00
40	0,000E+00	9,668E+01	0,000E+00	0,000E+00
41	1,160E+03	9,668E+01	0,000E+00	0,000E+00
42	1,160E+03	6,445E+01	0,000E+00	0,000E+00
43	0,000E+00	9,668E+01	0,000E+00	0,000E+00

44	1,160E+03	9,667E+01	0,000E+00	0,000E+00
45	1,160E+03	6,445E+01	0,000E+00	0,000E+00
46	0,000E+00	9,668E+01	0,000E+00	0,000E+00
47	1,160E+03	9,668E+01	0,000E+00	0,000E+00
48	1,160E+03	6,445E+01	0,000E+00	0,000E+00
49	0,000E+00	9,668E+01	0,000E+00	0,000E+00
50	1,160E+03	9,668E+01	0,000E+00	0,000E+00
51	1,160E+03	6,445E+01	0,000E+00	0,000E+00
52	0,000E+00	9,668E+01	0,000E+00	0,000E+00
53	1,160E+03	9,668E+01	0,000E+00	0,000E+00
54	1,160E+03	6,445E+01	0,000E+00	0,000E+00
55	0,000E+00	9,668E+01	0,000E+00	0,000E+00
56	1,160E+03	9,668E+01	0,000E+00	0,000E+00
57	1,160E+03	6,445E+01	0,000E+00	0,000E+00
58	0,000E+00	9,668E+01	0,000E+00	0,000E+00
59	1,160E+03	9,667E+01	0,000E+00	0,000E+00
60	1,160E+03	6,445E+01	0,000E+00	0,000E+00
61	0,000E+00	9,668E+01	0,000E+00	0,000E+00
62	1,160E+03	9,668E+01	0,000E+00	0,000E+00
63	1,160E+03	6,445E+01	0,000E+00	0,000E+00
64	1,160E+03	9,668E+01	0,000E+00	0,000E+00
65	0,000E+00	1,289E+02	0,000E+00	0,000E+00
66	1,160E+03	9,667E+01	0,000E+00	0,000E+00
67	1,160E+03	6,445E+01	0,000E+00	0,000E+00
68	0,000E+00	9,668E+01	0,000E+00	0,000E+00
69	1,160E+03	9,668E+01	0,000E+00	0,000E+00
70	1,160E+03	6,445E+01	0,000E+00	0,000E+00
71	3,222E+01	6,445E+01	0,000E+00	0,000E+00
72	1,257E+03	3,223E+01	0,000E+00	0,000E+00
73	1,289E+03	0,000E+00	0,000E+00	0,000E+00
74	9,668E+01	0,000E+00	0,000E+00	0,000E+00
75	1,225E+03	0,000E+00	0,000E+00	0,000E+00
76	1,257E+03	0,000E+00	0,000E+00	0,000E+00
77	9,668E+01	0,000E+00	0,000E+00	0,000E+00
78	1,225E+03	0,000E+00	0,000E+00	0,000E+00
79	1,257E+03	0,000E+00	0,000E+00	0,000E+00
80	9,668E+01	0,000E+00	0,000E+00	0,000E+00
81	1,192E+03	0,000E+00	8,280E+00	5,288E+00
82	1,160E+03	0,000E+00	2,484E+01	1,946E+01
83	9,668E+01	0,000E+00	3,312E+01	3,555E+01
84	1,063E+03	0,000E+00	4,140E+01	5,524E+01
85	1,031E+03	0,000E+00	5,796E+01	8,381E+01
86	9,668E+01	0,000E+00	5,796E+01	1,090E+02
87	9,345E+02	0,000E+00	5,796E+01	1,342E+02
88	9,023E+02	0,000E+00	8,280E+01	1,753E+02
89	9,668E+01	0,000E+00	9,108E+01	2,166E+02
90	8,056E+02	0,000E+00	9,108E+01	2,562E+02
91	7,734E+02	0,000E+00	1,076E+02	3,063E+02
92	9,668E+01	0,000E+00	1,076E+02	3,531E+02

93	6,767E+02	0,000E+00	1,159E+02	4,052E+02
94	6,445E+02	0,000E+00	1,408E+02	4,715E+02
95	9,668E+01	0,000E+00	1,490E+02	5,380E+02
96	5,478E+02	0,000E+00	1,573E+02	6,081E+02
97	5,156E+02	0,000E+00	1,739E+02	6,870E+02
98	4,834E+02	0,000E+00	1,656E+02	7,574E+02
99	6,445E+01	0,000E+00	1,822E+02	8,399E+02
100	3,867E+02	0,000E+00	1,987E+02	9,297E+02
101	3,545E+02	0,000E+00	1,987E+02	1,016E+03
102	6,445E+01	0,000E+00	2,070E+02	1,108E+03
103	2,578E+02	0,000E+00	2,236E+02	1,209E+03
104	2,578E+02	0,000E+00	2,236E+02	1,306E+03
105	9,668E+01	0,000E+00	2,318E+02	1,408E+03
106	9,668E+01	0,000E+00	2,567E+02	1,524E+03
107	9,668E+01	0,000E+00	2,567E+02	1,636E+03
108	9,668E+01	0,000E+00	2,650E+02	1,753E+03
109	3,222E+01	0,000E+00	2,732E+02	1,874E+03
110	0,000E+00	0,000E+00	2,815E+02	1,997E+03
111	0,000E+00	0,000E+00	2,815E+02	2,120E+03
112	0,000E+00	0,000E+00	2,815E+02	2,242E+03
113	0,000E+00	0,000E+00	2,732E+02	2,360E+03
114	0,000E+00	0,000E+00	2,732E+02	2,479E+03
115	0,000E+00	0,000E+00	2,732E+02	2,598E+03
116	0,000E+00	0,000E+00	2,732E+02	2,716E+03
117	0,000E+00	0,000E+00	2,898E+02	2,845E+03
118	0,000E+00	0,000E+00	2,815E+02	2,966E+03
119	0,000E+00	0,000E+00	2,732E+02	3,084E+03
120	0,000E+00	0,000E+00	0,000E+00	0,000E+00

Table 17: Fabricated PWR UOX and MOX and FR MOX (fuel) and UOXs (blankets) annual fluxes for the third scenario.

The corresponding irradiated fuel inventories are summarized in Table 18 referring to the status of the respective SF interim storages.

YEAR	UOX	MOX	FR MOX	FR Blanket
	tons	tons	tons	tons
-2	1,000E+04	0,000E+00	0,000E+00	0,000E+00
-1	9,594E+03	0,000E+00	0,000E+00	0,000E+00
0	8,363E+03	0,000E+00	0,000E+00	0,000E+00
1	6,702E+03	0,000E+00	0,000E+00	0,000E+00
2	5,442E+03	0,000E+00	0,000E+00	0,000E+00
3	4,595E+03	0,000E+00	0,000E+00	0,000E+00
4	3,317E+03	0,000E+00	0,000E+00	0,000E+00
5	3,315E+03	0,000E+00	0,000E+00	0,000E+00
6	2,448E+03	3,222E+01	0,000E+00	0,000E+00
7	2,546E+03	9,668E+01	0,000E+00	0,000E+00



8	3,738E+03	1,611E+02	0,000E+00	0,000E+00
9	3,738E+03	2,578E+02	0,000E+00	0,000E+00
10	4,898E+03	3,545E+02	0,000E+00	0,000E+00
11	4,936E+03	4,189E+02	0,000E+00	0,000E+00
12	4,396E+03	5,156E+02	0,000E+00	0,000E+00
13	4,673E+03	6,123E+02	0,000E+00	0,000E+00
14	4,711E+03	6,767E+02	0,000E+00	0,000E+00
15	4,268E+03	7,734E+02	0,000E+00	0,000E+00
16	4,640E+03	8,701E+02	0,000E+00	0,000E+00
17	4,678E+03	9,345E+02	0,000E+00	0,000E+00
18	4,268E+03	1,031E+03	0,000E+00	0,000E+00
19	4,640E+03	1,128E+03	0,000E+00	0,000E+00
20	4,678E+03	1,192E+03	0,000E+00	0,000E+00
21	4,268E+03	1,289E+03	0,000E+00	0,000E+00
22	4,640E+03	1,386E+03	0,000E+00	0,000E+00
23	4,678E+03	1,450E+03	0,000E+00	0,000E+00
24	4,268E+03	1,547E+03	0,000E+00	0,000E+00
25	4,640E+03	1,643E+03	0,000E+00	0,000E+00
26	4,678E+03	1,708E+03	0,000E+00	0,000E+00
27	4,268E+03	1,805E+03	0,000E+00	0,000E+00
28	4,640E+03	1,901E+03	0,000E+00	0,000E+00
29	4,678E+03	1,966E+03	0,000E+00	0,000E+00
30	4,268E+03	2,062E+03	0,000E+00	0,000E+00
31	4,640E+03	2,159E+03	0,000E+00	0,000E+00
32	4,640E+03	2,224E+03	0,000E+00	0,000E+00
33	4,678E+03	2,320E+03	0,000E+00	0,000E+00
34	4,268E+03	2,449E+03	0,000E+00	0,000E+00
35	4,640E+03	2,546E+03	0,000E+00	0,000E+00
36	4,678E+03	2,610E+03	0,000E+00	0,000E+00
37	4,268E+03	2,707E+03	0,000E+00	0,000E+00
38	4,640E+03	2,804E+03	0,000E+00	0,000E+00
39	4,678E+03	2,868E+03	0,000E+00	0,000E+00
40	4,268E+03	2,965E+03	0,000E+00	0,000E+00
41	4,640E+03	3,061E+03	0,000E+00	0,000E+00
42	4,678E+03	3,126E+03	0,000E+00	0,000E+00
43	4,268E+03	3,222E+03	0,000E+00	0,000E+00
44	4,640E+03	3,319E+03	0,000E+00	0,000E+00
45	4,678E+03	3,384E+03	0,000E+00	0,000E+00
46	4,268E+03	3,480E+03	0,000E+00	0,000E+00
47	4,640E+03	3,577E+03	0,000E+00	0,000E+00
48	4,678E+03	3,641E+03	0,000E+00	0,000E+00
49	4,268E+03	3,738E+03	0,000E+00	0,000E+00
50	4,640E+03	3,835E+03	0,000E+00	0,000E+00
51	4,678E+03	3,899E+03	0,000E+00	0,000E+00
52	4,268E+03	3,996E+03	0,000E+00	0,000E+00
53	4,640E+03	4,093E+03	0,000E+00	0,000E+00
54	4,678E+03	4,157E+03	0,000E+00	0,000E+00
55	4,268E+03	4,254E+03	0,000E+00	0,000E+00
56	4,640E+03	4,350E+03	0,000E+00	0,000E+00

	Centro Ricerche Bologna	<b>Sigla di identificazione</b>	Rev.	Distrib.	Pag.	di
		FPN – P9LU-034	0	L	48	60

57	4,678E+03	4,415E+03	0,000E+00	0,000E+00
58	4,268E+03	4,511E+03	0,000E+00	0,000E+00
59	4,640E+03	4,608E+03	0,000E+00	0,000E+00
60	4,678E+03	4,673E+03	0,000E+00	0,000E+00
61	4,268E+03	4,769E+03	0,000E+00	0,000E+00
62	4,640E+03	4,866E+03	0,000E+00	0,000E+00
63	4,640E+03	4,930E+03	0,000E+00	0,000E+00
64	4,678E+03	5,027E+03	0,000E+00	0,000E+00
65	4,268E+03	5,156E+03	0,000E+00	0,000E+00
66	4,640E+03	5,253E+03	0,000E+00	0,000E+00
67	4,678E+03	5,317E+03	0,000E+00	0,000E+00
68	4,268E+03	5,414E+03	0,000E+00	0,000E+00
69	4,678E+03	5,510E+03	0,000E+00	0,000E+00
70	5,465E+03	5,575E+03	0,000E+00	0,000E+00
71	5,465E+03	5,672E+03	0,000E+00	0,000E+00
72	6,625E+03	5,768E+03	0,000E+00	0,000E+00
73	7,785E+03	5,833E+03	0,000E+00	0,000E+00
74	7,785E+03	5,929E+03	0,000E+00	0,000E+00
75	8,945E+03	6,026E+03	0,000E+00	0,000E+00
76	1,014E+04	6,091E+03	0,000E+00	0,000E+00
77	1,020E+04	6,155E+03	0,000E+00	0,000E+00
78	1,143E+04	6,187E+03	0,000E+00	0,000E+00
79	1,260E+04	6,187E+03	0,000E+00	0,000E+00
80	1,246E+04	6,187E+03	0,000E+00	0,000E+00
81	1,335E+04	6,187E+03	0,000E+00	0,000E+00
82	1,420E+04	6,187E+03	0,000E+00	0,000E+00
83	1,372E+04	6,187E+03	0,000E+00	0,000E+00
84	1,436E+04	6,187E+03	0,000E+00	0,000E+00
85	1,504E+04	6,187E+03	0,000E+00	0,000E+00
86	1,431E+04	6,187E+03	0,000E+00	0,000E+00
87	1,459E+04	6,187E+03	8,280E+00	3,600E+00
88	1,484E+04	6,187E+03	3,312E+01	1,440E+01
89	1,387E+04	6,187E+03	6,624E+01	2,880E+01
90	1,386E+04	6,187E+03	1,076E+02	4,849E+01
91	1,374E+04	6,187E+03	1,573E+02	7,346E+01
92	1,245E+04	6,187E+03	2,070E+02	9,844E+01
93	1,193E+04	6,187E+03	2,732E+02	1,340E+02
94	1,129E+04	6,187E+03	3,560E+02	1,801E+02
95	9,707E+03	6,187E+03	4,388E+02	2,262E+02
96	8,920E+03	6,187E+03	5,382E+02	2,829E+02
97	7,956E+03	6,187E+03	6,458E+02	3,449E+02
98	6,789E+03	6,187E+03	7,452E+02	4,016E+02
99	5,001E+03	6,187E+03	8,694E+02	4,742E+02
100	3,746E+03	6,187E+03	1,010E+03	5,573E+02
101	2,771E+03	6,093E+03	1,151E+03	6,388E+02
102	2,062E+03	5,844E+03	1,308E+03	7,308E+02
103	2,481E+03	5,451E+03	1,474E+03	8,281E+02
104	2,320E+03	5,113E+03	1,639E+03	9,271E+02
105	1,772E+03	4,762E+03	1,822E+03	1,037E+03



	Centro Ricerche Bologna	Sigla di identificazione			Rev.	Distrib.	Pag.	di
		FPN – P9LU-034			0	L	50	60

10	0,000E+00	0,000E+00	0,000E+00	0,000E+00	0,000E+00	0,000E+00
11	1,123E+03	0,000E+00	0,000E+00	0,000E+00	1,461E+01	0,000E+00
12	5,394E+02	0,000E+00	0,000E+00	0,000E+00	7,027E+00	0,000E+00
13	8,838E+02	0,000E+00	0,000E+00	0,000E+00	1,149E+01	0,000E+00
14	1,123E+03	0,000E+00	0,000E+00	0,000E+00	1,461E+01	0,000E+00
15	4,428E+02	0,000E+00	0,000E+00	0,000E+00	5,773E+00	0,000E+00
16	7,872E+02	0,000E+00	0,000E+00	0,000E+00	1,024E+01	0,000E+00
17	1,123E+03	0,000E+00	0,000E+00	0,000E+00	1,461E+01	0,000E+00
18	4,105E+02	0,000E+00	0,000E+00	0,000E+00	5,355E+00	0,000E+00
19	7,872E+02	0,000E+00	0,000E+00	0,000E+00	1,024E+01	0,000E+00
20	1,123E+03	0,000E+00	0,000E+00	0,000E+00	1,461E+01	0,000E+00
21	4,105E+02	0,000E+00	0,000E+00	0,000E+00	5,355E+00	0,000E+00
22	7,872E+02	0,000E+00	0,000E+00	0,000E+00	1,024E+01	0,000E+00
23	1,123E+03	0,000E+00	0,000E+00	0,000E+00	1,461E+01	0,000E+00
24	4,105E+02	0,000E+00	0,000E+00	0,000E+00	5,355E+00	0,000E+00
25	7,872E+02	0,000E+00	0,000E+00	0,000E+00	1,024E+01	0,000E+00
26	1,123E+03	0,000E+00	0,000E+00	0,000E+00	1,461E+01	0,000E+00
27	4,105E+02	0,000E+00	0,000E+00	0,000E+00	5,355E+00	0,000E+00
28	7,872E+02	0,000E+00	0,000E+00	0,000E+00	1,024E+01	0,000E+00
29	1,123E+03	0,000E+00	0,000E+00	0,000E+00	1,461E+01	0,000E+00
30	4,105E+02	0,000E+00	0,000E+00	0,000E+00	5,355E+00	0,000E+00
31	7,872E+02	0,000E+00	0,000E+00	0,000E+00	1,024E+01	0,000E+00
32	1,160E+03	0,000E+00	0,000E+00	0,000E+00	1,510E+01	0,000E+00
33	1,123E+03	0,000E+00	0,000E+00	0,000E+00	1,461E+01	0,000E+00
34	4,105E+02	0,000E+00	0,000E+00	0,000E+00	5,355E+00	0,000E+00
35	7,872E+02	0,000E+00	0,000E+00	0,000E+00	1,024E+01	0,000E+00
36	1,123E+03	0,000E+00	0,000E+00	0,000E+00	1,461E+01	0,000E+00
37	4,105E+02	0,000E+00	0,000E+00	0,000E+00	5,355E+00	0,000E+00
38	7,872E+02	0,000E+00	0,000E+00	0,000E+00	1,024E+01	0,000E+00
39	1,123E+03	0,000E+00	0,000E+00	0,000E+00	1,461E+01	0,000E+00
40	4,105E+02	0,000E+00	0,000E+00	0,000E+00	5,355E+00	0,000E+00
41	7,872E+02	0,000E+00	0,000E+00	0,000E+00	1,024E+01	0,000E+00
42	1,123E+03	0,000E+00	0,000E+00	0,000E+00	1,461E+01	0,000E+00
43	4,105E+02	0,000E+00	0,000E+00	0,000E+00	5,355E+00	0,000E+00
44	7,872E+02	0,000E+00	0,000E+00	0,000E+00	1,024E+01	0,000E+00
45	1,123E+03	0,000E+00	0,000E+00	0,000E+00	1,461E+01	0,000E+00
46	4,105E+02	0,000E+00	0,000E+00	0,000E+00	5,355E+00	0,000E+00
47	7,872E+02	0,000E+00	0,000E+00	0,000E+00	1,024E+01	0,000E+00
48	1,123E+03	0,000E+00	0,000E+00	0,000E+00	1,461E+01	0,000E+00
49	4,105E+02	0,000E+00	0,000E+00	0,000E+00	5,355E+00	0,000E+00
50	7,872E+02	0,000E+00	0,000E+00	0,000E+00	1,024E+01	0,000E+00
51	1,123E+03	0,000E+00	0,000E+00	0,000E+00	1,461E+01	0,000E+00
52	4,105E+02	0,000E+00	0,000E+00	0,000E+00	5,355E+00	0,000E+00
53	7,872E+02	0,000E+00	0,000E+00	0,000E+00	1,024E+01	0,000E+00
54	1,123E+03	0,000E+00	0,000E+00	0,000E+00	1,461E+01	0,000E+00
55	4,105E+02	0,000E+00	0,000E+00	0,000E+00	5,355E+00	0,000E+00
56	7,872E+02	0,000E+00	0,000E+00	0,000E+00	1,024E+01	0,000E+00
57	1,123E+03	0,000E+00	0,000E+00	0,000E+00	1,461E+01	0,000E+00
58	4,105E+02	0,000E+00	0,000E+00	0,000E+00	5,355E+00	0,000E+00

59	7,872E+02	0,000E+00	0,000E+00	0,000E+00	1,024E+01	0,000E+00
60	1,123E+03	0,000E+00	0,000E+00	0,000E+00	1,461E+01	0,000E+00
61	4,105E+02	0,000E+00	0,000E+00	0,000E+00	5,355E+00	0,000E+00
62	7,872E+02	0,000E+00	0,000E+00	0,000E+00	1,024E+01	0,000E+00
63	1,160E+03	0,000E+00	0,000E+00	0,000E+00	1,510E+01	0,000E+00
64	1,123E+03	0,000E+00	0,000E+00	0,000E+00	1,461E+01	0,000E+00
65	4,105E+02	0,000E+00	0,000E+00	0,000E+00	5,355E+00	0,000E+00
66	7,872E+02	0,000E+00	0,000E+00	0,000E+00	1,024E+01	0,000E+00
67	1,123E+03	0,000E+00	0,000E+00	0,000E+00	1,461E+01	0,000E+00
68	4,105E+02	0,000E+00	0,000E+00	0,000E+00	5,355E+00	0,000E+00
69	7,496E+02	0,000E+00	0,000E+00	0,000E+00	9,748E+00	0,000E+00
70	3,735E+02	0,000E+00	0,000E+00	0,000E+00	4,867E+00	0,000E+00
71	0,000E+00	0,000E+00	0,000E+00	0,000E+00	0,000E+00	0,000E+00
72	0,000E+00	0,000E+00	0,000E+00	0,000E+00	0,000E+00	0,000E+00
73	0,000E+00	0,000E+00	0,000E+00	0,000E+00	0,000E+00	0,000E+00
74	0,000E+00	0,000E+00	0,000E+00	0,000E+00	0,000E+00	0,000E+00
75	0,000E+00	0,000E+00	0,000E+00	0,000E+00	0,000E+00	0,000E+00
76	0,000E+00	0,000E+00	0,000E+00	0,000E+00	0,000E+00	0,000E+00
77	0,000E+00	0,000E+00	0,000E+00	0,000E+00	0,000E+00	0,000E+00
78	0,000E+00	0,000E+00	0,000E+00	0,000E+00	0,000E+00	0,000E+00
79	8,059E+01	0,000E+00	0,000E+00	0,000E+00	0,000E+00	1,214E+00
80	2,439E+02	0,000E+00	0,000E+00	0,000E+00	0,000E+00	3,655E+00
81	3,281E+02	0,000E+00	0,000E+00	0,000E+00	0,000E+00	4,891E+00
82	4,109E+02	0,000E+00	0,000E+00	0,000E+00	0,000E+00	6,119E+00
83	5,771E+02	0,000E+00	0,000E+00	0,000E+00	0,000E+00	8,578E+00
84	5,791E+02	0,000E+00	0,000E+00	0,000E+00	0,000E+00	8,590E+00
85	5,793E+02	0,000E+00	0,000E+00	0,000E+00	0,000E+00	8,591E+00
86	8,280E+02	0,000E+00	0,000E+00	0,000E+00	0,000E+00	1,228E+01
87	9,114E+02	0,000E+00	0,000E+00	0,000E+00	0,000E+00	1,350E+01
88	9,110E+02	0,000E+00	0,000E+00	0,000E+00	0,000E+00	1,350E+01
89	1,073E+03	0,000E+00	0,000E+00	0,000E+00	0,000E+00	1,594E+01
90	1,070E+03	0,000E+00	0,000E+00	0,000E+00	0,000E+00	1,592E+01
91	1,149E+03	0,000E+00	0,000E+00	0,000E+00	0,000E+00	2,572E+01
92	1,390E+03	0,000E+00	0,000E+00	0,000E+00	0,000E+00	4,392E+01
93	1,462E+03	0,000E+00	0,000E+00	0,000E+00	0,000E+00	5,932E+01
94	1,535E+03	0,000E+00	0,000E+00	0,000E+00	0,000E+00	5,304E+01
95	1,685E+03	0,000E+00	0,000E+00	0,000E+00	0,000E+00	5,606E+01
96	1,594E+03	0,000E+00	0,000E+00	0,000E+00	0,000E+00	6,217E+01
97	1,738E+03	0,000E+00	0,000E+00	0,000E+00	0,000E+00	6,564E+01
98	1,877E+03	0,000E+00	0,000E+00	0,000E+00	0,000E+00	6,570E+01
99	1,853E+03	0,000E+00	0,000E+00	0,000E+00	0,000E+00	6,776E+01
100	1,900E+03	0,000E+00	0,000E+00	0,000E+00	0,000E+00	7,299E+01
101	1,539E+03	9,411E+01	0,000E+00	0,000E+00	0,000E+00	6,343E+01
102	7,734E+02	2,495E+02	0,000E+00	0,000E+00	0,000E+00	5,314E+01
103	9,668E+01	3,922E+02	0,000E+00	0,000E+00	0,000E+00	4,963E+01
104	6,767E+02	3,387E+02	0,000E+00	0,000E+00	0,000E+00	5,522E+01
105	6,445E+02	3,511E+02	0,000E+00	0,000E+00	0,000E+00	5,717E+01
106	3,182E+02	4,352E+02	0,000E+00	0,000E+00	0,000E+00	4,689E+01
107	3,263E+02	4,471E+02	0,000E+00	0,000E+00	0,000E+00	3,597E+01

108	5,156E+02	4,208E+02	0,000E+00	0,000E+00	0,000E+00	1,380E+01
109	3,922E+02	4,449E+02	0,000E+00	0,000E+00	0,000E+00	1,218E+01
110	1,557E+02	4,912E+02	0,000E+00	0,000E+00	0,000E+00	9,098E+00
111	3,867E+02	4,247E+02	0,000E+00	0,000E+00	0,000E+00	1,191E+01
112	3,867E+02	4,210E+02	0,000E+00	0,000E+00	0,000E+00	1,191E+01
113	9,668E+01	4,770E+02	0,000E+00	0,000E+00	0,000E+00	8,116E+00
114	2,256E+02	4,451E+02	0,000E+00	0,000E+00	0,000E+00	9,801E+00
115	2,256E+02	4,691E+02	0,000E+00	0,000E+00	0,000E+00	1,022E+01
116	9,668E+01	2,854E+02	0,000E+00	1,958E+02	0,000E+00	8,324E+00
117	9,668E+01	0,000E+00	0,000E+00	4,763E+02	0,000E+00	8,116E+00
118	0,000E+00	0,000E+00	0,000E+00	0,000E+00	0,000E+00	0,000E+00
119	0,000E+00	0,000E+00	0,000E+00	0,000E+00	0,000E+00	0,000E+00
120	0,000E+00	0,000E+00	0,000E+00	0,000E+00	0,000E+00	0,000E+00

Table 19: Reprocessed PWR UOX and MOX, FR MOX (fuel) and UOXs (blankets) and recycled Pu and Pu+MAAs annual fluxes for the third scenario.

Finally, the chemical composition of the wastes (Pu and MAAs from reprocessing and treatment losses, together with FPs) and both the reprocessed U inventory and the U losses are shown in Tables 20-21.

YEAR	Pu losses	Am losses	Np losses	Cm losses	Waste (FP)
	tons	tons	tons	tons	tons
-2	0,000E+00	0,000E+00	0,000E+00	0,000E+00	0,000E+00
-1	5,011E-03	1,216E-05	4,876E-09	0,000E+00	2,514E+01
0	2,011E-02	5,954E-05	5,268E-08	0,000E+00	1,014E+02
1	3,522E-02	1,620E-04	2,253E-07	0,000E+00	2,042E+02
2	4,524E-02	3,254E-04	6,117E-07	0,000E+00	2,822E+02
3	6,035E-02	5,351E-04	1,292E-06	0,000E+00	3,346E+02
4	7,549E-02	7,856E-04	2,345E-06	0,000E+00	4,137E+02
5	8,548E-02	1,082E-03	3,837E-06	0,000E+00	4,936E+02
6	1,006E-01	1,412E-03	5,826E-06	0,000E+00	5,473E+02
7	1,159E-01	1,772E-03	8,370E-06	0,000E+00	6,190E+02
8	1,189E-01	2,158E-03	1,152E-05	0,000E+00	6,190E+02
9	1,184E-01	2,530E-03	1,527E-05	0,000E+00	6,190E+02
10	1,180E-01	2,883E-03	1,961E-05	0,000E+00	6,190E+02
11	1,225E-01	3,224E-03	2,449E-05	0,000E+00	6,883E+02
12	1,340E-01	3,612E-03	2,996E-05	0,000E+00	7,216E+02
13	1,481E-01	4,039E-03	3,607E-05	0,000E+00	7,762E+02
14	1,542E-01	4,510E-03	4,291E-05	0,000E+00	8,455E+02
15	1,643E-01	5,024E-03	5,054E-05	0,000E+00	8,728E+02
16	1,783E-01	5,567E-03	5,900E-05	0,000E+00	9,214E+02
17	1,830E-01	6,141E-03	6,837E-05	0,000E+00	9,907E+02
18	1,926E-01	6,751E-03	7,869E-05	0,000E+00	1,016E+03
19	2,065E-01	7,385E-03	8,999E-05	0,000E+00	1,065E+03
20	2,111E-01	8,043E-03	1,023E-04	0,000E+00	1,134E+03
21	2,206E-01	8,734E-03	1,158E-04	0,000E+00	1,159E+03
22	2,344E-01	9,446E-03	1,303E-04	0,000E+00	1,208E+03

23	2,389E-01	1,018E-02	1,460E-04	0,000E+00	1,277E+03
24	2,483E-01	1,094E-02	1,629E-04	0,000E+00	1,303E+03
25	2,620E-01	1,171E-02	1,810E-04	0,000E+00	1,351E+03
26	2,665E-01	1,251E-02	2,004E-04	0,000E+00	1,420E+03
27	2,758E-01	1,333E-02	2,211E-04	0,000E+00	1,446E+03
28	2,895E-01	1,416E-02	2,431E-04	0,000E+00	1,494E+03
29	2,939E-01	1,500E-02	2,664E-04	0,000E+00	1,564E+03
30	3,031E-01	1,587E-02	2,911E-04	0,000E+00	1,589E+03
31	3,172E-01	1,676E-02	3,173E-04	0,000E+00	1,638E+03
32	3,308E-01	1,765E-02	3,448E-04	0,000E+00	1,709E+03
33	3,351E-01	1,856E-02	3,738E-04	0,000E+00	1,779E+03
34	3,442E-01	1,949E-02	4,042E-04	0,000E+00	1,804E+03
35	3,578E-01	2,041E-02	4,362E-04	0,000E+00	1,853E+03
36	3,620E-01	2,136E-02	4,696E-04	0,000E+00	1,922E+03
37	3,711E-01	2,232E-02	5,046E-04	0,000E+00	1,947E+03
38	3,846E-01	2,328E-02	5,411E-04	0,000E+00	1,996E+03
39	3,888E-01	2,426E-02	5,791E-04	0,000E+00	2,065E+03
40	3,979E-01	2,525E-02	6,188E-04	0,000E+00	2,090E+03
41	4,114E-01	2,624E-02	6,600E-04	0,000E+00	2,139E+03
42	4,155E-01	2,724E-02	7,028E-04	0,000E+00	2,208E+03
43	4,246E-01	2,826E-02	7,472E-04	0,000E+00	2,234E+03
44	4,380E-01	2,927E-02	7,932E-04	0,000E+00	2,282E+03
45	4,421E-01	3,029E-02	8,409E-04	0,000E+00	2,352E+03
46	4,511E-01	3,133E-02	8,902E-04	0,000E+00	2,377E+03
47	4,645E-01	3,236E-02	9,412E-04	0,000E+00	2,426E+03
48	4,686E-01	3,340E-02	9,938E-04	0,000E+00	2,495E+03
49	4,775E-01	3,445E-02	1,048E-03	0,000E+00	2,520E+03
50	4,909E-01	3,550E-02	1,104E-03	0,000E+00	2,569E+03
51	4,950E-01	3,656E-02	1,162E-03	0,000E+00	2,638E+03
52	5,039E-01	3,762E-02	1,221E-03	0,000E+00	2,663E+03
53	5,172E-01	3,869E-02	1,282E-03	0,000E+00	2,712E+03
54	5,213E-01	3,975E-02	1,345E-03	0,000E+00	2,781E+03
55	5,302E-01	4,083E-02	1,410E-03	0,000E+00	2,807E+03
56	5,435E-01	4,190E-02	1,476E-03	0,000E+00	2,855E+03
57	5,475E-01	4,297E-02	1,544E-03	0,000E+00	2,925E+03
58	5,564E-01	4,406E-02	1,613E-03	0,000E+00	2,950E+03
59	5,697E-01	4,515E-02	1,685E-03	0,000E+00	2,999E+03
60	5,737E-01	4,622E-02	1,758E-03	0,000E+00	3,068E+03
61	5,825E-01	4,732E-02	1,833E-03	0,000E+00	3,093E+03
62	5,958E-01	4,841E-02	1,909E-03	0,000E+00	3,142E+03
63	5,998E-01	4,949E-02	1,988E-03	0,000E+00	3,213E+03
64	6,086E-01	5,059E-02	2,068E-03	0,000E+00	3,283E+03
65	6,223E-01	5,169E-02	2,150E-03	0,000E+00	3,308E+03
66	6,356E-01	5,278E-02	2,233E-03	0,000E+00	3,357E+03
67	6,395E-01	5,388E-02	2,319E-03	0,000E+00	3,426E+03
68	6,484E-01	5,498E-02	2,406E-03	0,000E+00	3,451E+03
69	6,616E-01	5,608E-02	2,495E-03	0,000E+00	3,498E+03
70	6,650E-01	5,718E-02	2,585E-03	0,000E+00	3,521E+03
71	6,636E-01	5,824E-02	2,678E-03	0,000E+00	3,521E+03
72	6,623E-01	5,926E-02	2,772E-03	0,000E+00	3,521E+03



73	6,610E-01	6,022E-02	2,867E-03	0,000E+00	3,521E+03
74	6,598E-01	6,112E-02	2,965E-03	0,000E+00	3,521E+03
75	6,586E-01	6,198E-02	3,063E-03	0,000E+00	3,521E+03
76	6,575E-01	6,280E-02	3,163E-03	0,000E+00	3,521E+03
77	6,564E-01	6,356E-02	3,264E-03	0,000E+00	3,521E+03
78	6,553E-01	6,429E-02	3,366E-03	0,000E+00	3,521E+03
79	6,553E-01	6,498E-02	3,470E-03	0,000E+00	3,526E+03
80	6,574E-01	6,564E-02	3,574E-03	0,000E+00	3,541E+03
81	6,605E-01	6,627E-02	3,680E-03	0,000E+00	3,561E+03
82	6,636E-01	6,688E-02	3,787E-03	0,000E+00	3,586E+03
83	6,678E-01	6,747E-02	3,894E-03	0,000E+00	3,622E+03
84	6,740E-01	6,805E-02	4,003E-03	0,000E+00	3,658E+03
85	6,813E-01	6,863E-02	4,112E-03	0,000E+00	3,693E+03
86	6,896E-01	6,919E-02	4,222E-03	0,000E+00	3,744E+03
87	6,989E-01	6,976E-02	4,334E-03	0,000E+00	3,801E+03
88	7,082E-01	7,034E-02	4,446E-03	0,000E+00	3,857E+03
89	7,195E-01	7,092E-02	4,559E-03	0,000E+00	3,923E+03
90	7,328E-01	7,151E-02	4,673E-03	0,000E+00	3,989E+03
91	7,461E-01	7,211E-02	4,788E-03	0,000E+00	4,060E+03
92	7,613E-01	7,274E-02	4,904E-03	0,000E+00	4,146E+03
93	7,785E-01	7,339E-02	5,021E-03	0,000E+00	4,236E+03
94	7,947E-01	7,408E-02	5,139E-03	0,000E+00	4,331E+03
95	8,137E-01	7,480E-02	5,258E-03	0,000E+00	4,435E+03
96	8,336E-01	7,556E-02	5,378E-03	0,000E+00	4,533E+03
97	8,534E-01	7,637E-02	5,500E-03	0,000E+00	4,640E+03
98	8,750E-01	7,723E-02	5,623E-03	0,000E+00	4,756E+03
99	8,974E-01	7,815E-02	5,747E-03	0,000E+00	4,870E+03
100	9,196E-01	7,914E-02	5,873E-03	0,000E+00	4,988E+03
101	9,434E-01	8,021E-02	6,000E-03	0,000E+00	5,089E+03
102	9,782E-01	8,132E-02	6,130E-03	0,000E+00	5,152E+03
103	1,012E+00	8,243E-02	6,261E-03	0,000E+00	5,182E+03
104	1,048E+00	8,351E-02	6,394E-03	0,000E+00	5,245E+03
105	1,085E+00	8,458E-02	6,528E-03	0,000E+00	5,306E+03
106	1,124E+00	8,564E-02	6,664E-03	0,000E+00	5,352E+03
107	1,165E+00	8,668E-02	6,802E-03	0,000E+00	5,399E+03
108	1,207E+00	8,769E-02	6,942E-03	0,000E+00	5,457E+03
109	1,250E+00	8,870E-02	7,083E-03	0,000E+00	5,508E+03
110	1,291E+00	8,969E-02	7,226E-03	0,000E+00	5,547E+03
111	1,332E+00	9,066E-02	7,370E-03	0,000E+00	5,597E+03
112	1,375E+00	9,162E-02	7,516E-03	0,000E+00	5,647E+03
113	1,419E+00	9,258E-02	7,663E-03	0,000E+00	5,682E+03
114	1,460E+00	9,353E-02	7,812E-03	0,000E+00	5,723E+03
115	1,501E+00	9,447E-02	7,963E-03	0,000E+00	5,765E+03
116	1,543E+00	9,543E-02	8,115E-03	0,000E+00	5,791E+03
117	1,570E+00	9,637E-02	8,268E-03	0,000E+00	5,805E+03
118	1,581E+00	9,727E-02	8,423E-03	0,000E+00	
119	1,579E+00	9,812E-02	8,580E-03	0,000E+00	
120	1,578E+00	9,892E-02	8,738E-03	0,000E+00	
	1,577E+00	9,967E-02	8,896E-03		
	1,575E+00	1,004E-01	9,057E-03		



	1,574E+00	1,011E-01	9,218E-03		
	1,573E+00	1,017E-01	9,380E-03		
	1,571E+00	1,023E-01	9,543E-03		
	1,570E+00	1,028E-01	9,708E-03		
	1,569E+00	1,033E-01	9,873E-03		
	1,568E+00	1,038E-01	1,004E-02		
	1,567E+00	1,043E-01	1,020E-02		

Table 20: Wastes inventory for Pu, MAs and FPs produced by the third scenario evolution.

<b>YEAR</b>	<b>Rep U</b>	<b>U losses</b>
	tons	tons
-2	0,000E+00	0,000E+00
-1	3,751E+02	8,953E-07
0	1,512E+03	4,514E-06
1	3,047E+03	1,264E-05
2	4,210E+03	2,615E-05
3	4,992E+03	4,425E-05
4	6,173E+03	6,677E-05
5	7,365E+03	9,453E-05
6	8,166E+03	1,269E-04
7	9,236E+03	1,636E-04
8	9,236E+03	2,047E-04
9	9,236E+03	2,460E-04
10	9,236E+03	2,870E-04
11	1,027E+04	3,281E-04
12	1,077E+04	3,734E-04
13	1,159E+04	4,226E-04
14	1,262E+04	4,761E-04
15	1,303E+04	5,341E-04
16	1,376E+04	5,955E-04
17	1,479E+04	6,606E-04
18	1,517E+04	7,300E-04
19	1,590E+04	8,026E-04
20	1,694E+04	8,787E-04
21	1,732E+04	9,591E-04
22	1,804E+04	1,043E-03
23	1,908E+04	1,130E-03
24	1,946E+04	1,221E-03
25	2,018E+04	1,315E-03
26	2,122E+04	1,413E-03
27	2,160E+04	1,515E-03
28	2,233E+04	1,620E-03
29	2,336E+04	1,727E-03
30	2,374E+04	1,840E-03
31	2,447E+04	1,955E-03
32	2,554E+04	2,073E-03
33	2,658E+04	2,195E-03

34	2,695E+04	2,321E-03
35	2,768E+04	2,449E-03
36	2,872E+04	2,581E-03
37	2,910E+04	2,716E-03
38	2,982E+04	2,854E-03
39	3,086E+04	2,996E-03
40	3,124E+04	3,141E-03
41	3,197E+04	3,289E-03
42	3,300E+04	3,440E-03
43	3,338E+04	3,594E-03
44	3,411E+04	3,751E-03
45	3,514E+04	3,912E-03
46	3,552E+04	4,076E-03
47	3,625E+04	4,242E-03
48	3,729E+04	4,411E-03
49	3,766E+04	4,584E-03
50	3,839E+04	4,760E-03
51	3,943E+04	4,938E-03
52	3,981E+04	5,120E-03
53	4,053E+04	5,304E-03
54	4,157E+04	5,491E-03
55	4,195E+04	5,682E-03
56	4,268E+04	5,875E-03
57	4,371E+04	6,070E-03
58	4,409E+04	6,269E-03
59	4,482E+04	6,471E-03
60	4,585E+04	6,675E-03
61	4,623E+04	6,882E-03
62	4,696E+04	7,092E-03
63	4,803E+04	7,304E-03
64	4,907E+04	7,520E-03
65	4,945E+04	7,738E-03
66	5,017E+04	7,958E-03
67	5,121E+04	8,182E-03
68	5,159E+04	8,408E-03
69	5,228E+04	8,636E-03
70	5,262E+04	8,867E-03
71	5,262E+04	9,099E-03
72	5,262E+04	9,329E-03
73	5,262E+04	9,557E-03
74	5,262E+04	9,784E-03
75	5,262E+04	1,001E-02
76	5,262E+04	1,023E-02
77	5,262E+04	1,045E-02
78	5,262E+04	1,068E-02
79	5,270E+04	1,089E-02
80	5,292E+04	1,111E-02
81	5,323E+04	1,133E-02
82	5,360E+04	1,155E-02

83	5,414E+04	1,177E-02
84	5,467E+04	1,199E-02
85	5,521E+04	1,221E-02
86	5,597E+04	1,243E-02
87	5,681E+04	1,266E-02
88	5,765E+04	1,289E-02
89	5,864E+04	1,312E-02
90	5,963E+04	1,335E-02
91	6,069E+04	1,359E-02
92	6,197E+04	1,383E-02
93	6,332E+04	1,408E-02
94	6,473E+04	1,434E-02
95	6,629E+04	1,460E-02
96	6,776E+04	1,486E-02
97	6,936E+04	1,513E-02
98	7,110E+04	1,541E-02
99	7,281E+04	1,570E-02
100	7,456E+04	1,600E-02
101	7,607E+04	1,630E-02
102	7,699E+04	1,661E-02
103	7,740E+04	1,693E-02
104	7,831E+04	1,726E-02
105	7,919E+04	1,760E-02
106	7,985E+04	1,796E-02
107	8,052E+04	1,833E-02
108	8,134E+04	1,871E-02
109	8,207E+04	1,910E-02
110	8,262E+04	1,951E-02
111	8,333E+04	1,994E-02
112	8,404E+04	2,038E-02
113	8,452E+04	2,084E-02
114	8,510E+04	2,131E-02
115	8,569E+04	2,180E-02
116	8,620E+04	2,231E-02
117	8,674E+04	2,282E-02
118		2,334E-02
119		
120		

Table 21: Reprocessed and lost U during the third scenario.

	<b>Centro Ricerche Bologna</b>	<b>Sigla di identificazione</b> FPN – P9LU-034	Rev. 0	Distrib. L	Pag. 58	di 60
---	--------------------------------	---	-----------	---------------	------------	----------

## 6 CONCLUDING REMARKS

The results obtained with the COSI6 code for the six benchmark cases are here presented, in order to initialize the ENEA WPFC-FCTS participation with a tools knowledge alignment.

As far as main isotopes, the ENEA results of the three depletion calculations agree within several percent with the ones published by the WPFC-FCTS.

The remaining three scenario simulations, which have no reference data to compare with, are here extensively reported to be examined by other WPFC-FCTS members.

## 7 ACKNOWLEDGEMENTS

The authors would like to thank the CEA for having provided ENEA with the COSI6 code, and in particular prof. Lionel Boucher and dr. Maryan Meyer of CEA-Cadarache for the initial training course and the continuous support in the use of the code.

	<b>Centro Ricerche Bologna</b>	<b>Sigla di identificazione</b> FPN – P9LU-034	Rev. 0	Distrib. L	Pag. 59	di 60
---	--------------------------------	---	-----------	---------------	------------	----------

## A LIST OF ACRONYMS

ADS:	Accelerator Driven System
BBL:	BiBLiothèque de sections efficaces (effective cross sections library)
BU:	Burn Up
DU:	Depleted Uranium
EFIT:	European Facility for Industrial Transmutation
EFPD:	Effective Full-Power Day
ELSY:	European Lead SYstem
FIFO:	First In-First Out
FP:	Fission Product
FR:	Fast Reactor
HM:	Heavy Metal
MA:	Minor Actinide
MOX:	Mixed OXide
NU:	Natural Uranium
PWR:	Pressurized Water Reactor
SF:	Spent Fuel
SWU:	Separative Working Unit
UOX:	Uranium OXide

	<b>Centro Ricerche Bologna</b>	<b>Sigla di identificazione</b> FPN – P9LU-034	Rev. 0	Distrib. L	Pag. 60	di 60
---	--------------------------------	---	-----------	---------------	------------	----------

## REFERENCES

- [1] J. P. Grouiller *et al.* COSI, A Simulation Software for a Pool of Reactors and Fuel Cycle Plants: Application to the Study of the Deployment of Fast Breeder Reactors. In *Proceedings of Fast Reactors and Related Fuel Cycles*, KYOTO/Japan, October 1991.
- [2] Expert Group on Fuel Cycle Transition Scenarios Studies Working Party on Scientific Issues of the Fuel Cycle (WPFC). Specification for the benchmark devoted to scenario codes. Technical Report NEA/NSC/DOC(2007)13, OECD/NEA Nuclear Science Committee, July 2007.
- [3] L. Boucher. *COSI6: user manual*. CEA, June 2006.
- [4] M. Meyer. Equivalence reactivity coefficients. Private communication, January 2008.