



Agenzia Nazionale per le Nuove Tecnologie,
l'Energia e lo Sviluppo Economico Sostenibile



Ministero dello Sviluppo Economico

RICERCA DI SISTEMA ELETTRICO

Safety of evolutionary reactors: feasibility study for the experimental program of SPES facility

A. Kovtonyuk, M. Cherubini, M. Adorni, B. Bianucci, F. D'Auria

Report RdS/2011/53

SAFETY OF EVOLUTIONARY REACTORS: FEASIBILITY STUDY FOR THE EXPERIMENTAL
PROGRAM OF SPES FACILITY

A. Kovtonyuk, M. Cherubini, M. Adorni, B. Bianucci, F. D'auria - CIRTEN

Settembre 2011

Report Ricerca di Sistema Elettrico

Accordo di Programma Ministero dello Sviluppo Economico – ENEA

Area: Governo, Gestione e sviluppo del sistema elettrico nazionale

Progetto: Nuovo nucleare da fissione: collaborazioni internazionali e sviluppo competenze in
materia nucleare

Responsabile Progetto: Paride Meloni, ENEA



CIRTEN

Consorzio Interuniversitario per la Ricerca TEcnologica Nucleare

UNIVERSITY OF PISA

San Piero a Grado Nuclear Research Group

**Safety of evolutionary reactors:
feasibility study for the experimental program
of SPES facility**

A. Kovtonyuk

M. Cherubini

M. Adorni

B. Bianucci

F. D'Auria

CERSE-UNUPI RL 1097/2011

PISA, AGOSTO 2011

Lavoro svolto in esecuzione della linea progettuale LP2 punto E3
AdP MSE - ENEA "Ricerca di Sistema Elettrico" - PAR2008-09
Progetto 1.3 – "Nuovo Nucleare da Fissione".

(This page has been intentionally left blank)

Abstract

Il presente lavoro è svolto nell'ambito dell'Accordo di Programma MSE-ENEA sulla Ricerca di Sistema Elettrico, Piano Annuale di Realizzazione 2008-2009, per quanto attiene all'Area "Governance, gestione e Sviluppo del Sistema Elettrico Nazionale", tematica di ricerca "Energia Nucleare"; nello specifico, si riferisce agli obiettivi del progetto 1.3 "Nuovo Nucleare da Fissione: collaborazioni internazionali e sviluppo competenze in materia nucleare".

Il rapporto è preparato allo scopo di documentare le attività svolte per la seconda linea progettuale in cui è suddiviso l'accordo stesso: "reattori evolutivi". Nello specifico è preparato come deliverable della sezione LP2-E: "Sviluppo e validazione codici di calcolo" così suddiviso:

- LP2-E.1 Sviluppo e validazione dell'accoppiamento di un codice d'impianto e di un codice di contenimento per l'analisi incidentale di reattori modulari.
- LP2-E.2 Partecipazione alle attività svolte presso il CEA a supporto della realizzazione del reattore Jules Horowitz Reactor.
- LP2-E.3 Definizione di un programma sperimentale da eseguire sulla facility SPES2 per studio tematiche rilevanti per la sicurezza dei reattori evolutivi (in particolare EPR e AP1000) e validazione dei relativi strumenti di calcolo.

In particolare questo documento è preparato come deliverable della sezione LP2-E3.

Il presente documento riguarda lo studio di fattibilità per un programma sperimentale da svolgersi presso l'impianto SPES. A causa della rilevanza dell'argomento della diluizione del boro relativamente alla sicurezza dei reattori nucleari, si è deciso di esaminare la possibilità di effettuare un tale esperimento nell'apparecchiatura SPES. In particolare, l'obiettivo dell'attività è quello di investigare la distribuzione di diluizione boro in condizione di quantità massa ridotta, ad esempio, durante un evento di "Small Break LOCA" (SB-LOCA). La diluizione del boro avviene quando le condizioni per il fenomeno del "reflux-condenser" vengono stabilite nell'impianto. Questo fenomeno produce un tappo di acqua de-borata nel circuito primario, in particolare nel "loop seal".

Lo SPES (Simulatore PWR per Esperienze di Sicurezza) è un'apparecchiatura sperimentale integrale situata a Piacenza (Italia). È stata progettata per simulare l'intero circuito primario, le parti principali del circuito secondario, ed i sistemi più significativi ausiliari e di emergenza e fa riferimento all'impianto standard nucleare italiano (PWR-PUN, Westinghouse tipo 312, 3 loop, 2775 MWth di potenza termica).

È stato scelto come riferimento per eseguire lo studio di fattibilità, il test OECD-PKL E2.2. Il test studia la distribuzione di boro all'interno dell'apparecchiatura sperimentale PKL durante l'iniezione asimmetrica degli ECCS (HPIS e LPIS nei loop 1 e 2) e il seguente riempimento dell'apparecchiatura

stessa. L'aspetto più rilevanti del test è costituito dalla distribuzione boro nell'apparecchiatura durante la transizione dalla condizione "*reflux-condenser*" alla condizione di circolazione naturale, con particolare attenzione ai tappi di acqua poco borata accumulata nei "*loop seals*".

Per realizzare l'obiettivo di riprodurre le condizioni del test PKL selezionato, è stata utilizzata una nodalization dell'apparecchiatura SPES disponibile presso l'Università di Pisa.

I risultati dei calcoli dimostrano che i principali aspetti termo-idraulici, che sono stati osservati nel test E2.2 presso l'apparecchiatura PKL, sono presenti anche nel test eseguito sullo SPES: modalità "*reflux-condenser*" e riempimento dell'impianto tramite l'intervento del sistema ECC, circolazione naturale in tutti i loop durante l'iniezione asimmetrica degli ECC e cambiamento della distribuzione boro nell'apparecchiatura stessa. Così, si può concludere che il test di diluizione di boro è fattibile nell'impianto SPES, con le condizioni al contorno specificate.

Inoltre, alcuni requisiti per il sistema di misura SPES sono stati identificati: l'impianto deve essere dotato di dispositivi di misurazione della concentrazione e della portata di boro allo scopo di eseguire la prova sperimentale e fornire informazioni significative per le successive analisi.

Il rapporto contiene la descrizione dell'apparecchiatura sperimentale PKL e del test selezionato e la descrizione dell'apparecchiatura sperimentale SPES. La sezione 4 è dedicata alla descrizione del codice adottato e della nodalizzazione ed è seguito dalla descrizione del test da effettuare in SPES e il suo obiettivo. I risultati dei calcoli sono riportati nella sezione 6. L'attività comprende anche alcuni suggerimenti per migliorare il sistema di misurazione dell'apparecchiatura SPES. Infine, le conclusioni sono riportate nell'ultima sezione.

Contents

Abstract	3
Contents	5
List of Abbreviations.....	6
List of Figures.....	8
List of Tables.....	9
1. Introduction	10
2. Description of the PKL facility and the experiment	12
2.1. PKL facility.....	12
2.2. Test E2.2 description	17
3. Description of the SPES facility	19
4. Adopted code and nodalization.....	21
4.1. RELAP5/Mod3.3 code.....	21
4.2. SPES nodalization description	22
5. SPES test description and objectives	29
5.1. Conditioning phase.....	29
5.2. Test phase.....	31
6. Analysis of calculation results.....	34
6.1. Conditioning phase.....	34
6.2. Test phase.....	39
7. Requirements to facility measurement system.....	45
8. Conclusions	49
References.....	50

List of Abbreviations

ACC	Accumulator
AFW	Auxiliary Feed-Water
BAF	Bottom of Active Fuel
BIC	Boundary and Initial Conditions
BL	Broken Loop
CCFL	Counter-Current Flow Limitation
CIRTEN	Consorzio Interuniversitario per la Ricerca Tecnologica Nucleare
CL	Cold Leg
DC	Down-Comer
DIMNP	Dipartimento Ingegneria Meccanica, Nucleare e della Produzione
DP	Differential Pressure
ECC	Emergency Core Cooling
ECCS	Emergency Core Cooling Systems
EFW	Emergency Feed-Water
FW	Feed Water
HL	Hot Leg
HPIS	High Pressure Injection System
HPSI	High Pressure Safety Injection
HTC	Heat Transfer Coefficient
IL	Intact Loop
INEL	Idaho National Engineering Laboratory
ITF	Integral Test Facility
KWU	Kraft Werks Union
LBLOCA	Large Break Loss Of Coolant Accident
LOBI	LWR Off-normal Behavior Investigation
LOCA	Loss Of Coolant Accident
LP	Lower Plenum
LPIS	Low Pressure Injection System
LPSI	High Pressure Safety Injection
LWR	Light Water Reactor
MCP	Main Coolant Pump
NC	Natural Circulation
NCFM	Natural Circulation Flow Map
NCP	Natural Circulation Performance
NPP	Nuclear Power Plant
PKL	German acronym for "Primary System"
PORV	Pressurizer Operated Relief Valve
PRZ	Pressurizer
PS	Primary System
PWR	Pressure Water Reactor
RCNC	Reflux Condensation NC
RCS	Reactor Coolant System
RELAP	Reactor Excursion and Leak Analysis Program

RPV	Reactor Pressure Vessel
SBLOCA	Small Break Loss Of Coolant Accident
SCNC	Siphon Condensation NC
SCRAM	Safety Cut Rope Axe Man
SG	Steam Generator
SOT	Start of Test
SPES	Simulatore PWR per Esperienze di Sicurezza
SPNC	Single-Phase NC
SRV	Steam Relief Valve
SS	Secondary Side
SSCS	Secondary Side Cool-down System
TAF	Top of Active Fuel
TH	Thermal-Hydraulic
TPNC	Two-Phase NC
UH	Upper Head
UP	Upper Plenum
UNIFI	University of Pisa

List of Figures

Figure 1. PKL: general view of the facility	15
Figure 2. SPES system configuration	20
Figure 3. SPES facility nodalization for RELAP5 code	27
Figure 4. Test phase secondary side pressure	32
Figure 5. Test phase core power	32
Figure 6. Test phase HPSI injection flowrate	33
Figure 7. Test phase LPSI injection flowrate	33
Figure 8. Conditioning phase: Primary side pressure	35
Figure 9. Conditioning phase: Pressurizer level	35
Figure 10. Conditioning phase: Primary side and secondary side pressure	36
Figure 11. Conditioning phase: Mass flowrates in loop 1 and 2	36
Figure 12. Conditioning phase: Pressure drop across U-tubes loops 1 and 2	37
Figure 13. Conditioning phase: Primary side mass inventory	37
Figure 14. Conditioning phase: Boron concentration at loop seal bottom	38
Figure 15. Conditioning phase: Fluid temperatures in primary system.....	38
Figure 16. Test phase: Primary side and secondary side pressure	40
Figure 17. Test phase: Primary side mass inventory.....	40
Figure 18. Test phase: Pressurizer level	41
Figure 19. Test phase: Pressure drop across U-tubes	41
Figure 20. Test phase: Mass flowrate in the loops at the SG outlet	42
Figure 21. Test phase: Boron concentration at loop seal bottom	42
Figure 22. Test phase: Boron concentration in cold legs	43
Figure 23. Test phase: Boron concentration inside power channel	43
Figure 24. Test phase: Fluid temperatures in cold legs and lower plenum	44
Figure 25. COMBO device arrangement scheme	45
Figure 26. Conductivity sensors scheme	47
Figure 27. Mechanical interface between the probe and the coolant	48

List of Tables

Table 1. General data on PKL, LOBI, SPES, BETHSY and LSTF facilities	16
Table 2. SPES nodalization: Correspondences Between Nodes and Hydraulic Zones (part1).....	24
Table 3. SPES nodalization: Correspondences Between Nodes and Hydraulic Zones (part2).....	25
Table 4. SPES Nodalization Code Resources	26
Table 5. Baseline conditions of SOT state	29
Table 6. SPES initial conditions prior to conditioning phase.....	30
Table 7. Conditioning phase boundary conditions	30
Table 8. Test phase boundary conditions	31

1. Introduction

The present document is related to the feasibility study for an experimental program to be performed at the SPES facility. Due to the relevance of the boron dilution issue in the nuclear reactor safety, it has been decided to investigate the possibility to carry out such an experiment in the SPES facility. In particular, the objective of the activity is to investigate the boron dilution distribution in condition of reduced mass inventory, e.g. the SB-LOCA event. The boron dilution takes place when conditions for reflux-condenser phenomenon are established in the plant. This phenomenon produces de-borated water plug in the primary circuit namely in the loop seals.

The SPES (Simulatore PWR per Esperienze di Sicurezza) Integral Test Facility is an experimental facility located in Piacenza (Italy). It is designed to simulate the whole primary circuit, the relevant parts of the secondary circuit (steam generator secondary sides, main feed water lines up to the isolation valves, main steam lines upstream the turbine valves), and the most significant auxiliary and emergency systems (charging and let-down system, safety injection system, including high pressure and low pressure system, accumulators, emergency feed water system, steam dump and so on) of the Italian Standard Nuclear power plant (PWR-PUN, Westinghouse 312 type, 3 loops, 2775 MWth core power).

The test OECD-PKL E2.2 has been selected as a counterpart to perform the feasibility study. The test investigates the boron distribution inside the facility during the asymmetric ECCS injection (HPIS and LPIS in loop 1 and 2) and the following filling up of the facility. The main relevant aspect of the test is constituted by boron distribution in the facility during the transition between the reflux-condenser conditions to natural circulation conditions particularly paying attention to the low borated slug of water accumulated in the loop seals.

To fulfill the objective, a nodalization of SPES experimental facility available at UNIPI has been adopted to reproduce the conditions of the PKL selected test.

The calculation results demonstrated that the main thermal-hydraulic aspects, which have been observed in the test E2.2 at PKL facility, are present in the test phase in SPES facility: reflux-condenser mode, facility refill by ECC system intervention, natural circulation in all loops during asymmetric ECC injection and change of boron distribution in the facility. Thus, it may be concluded that boron dilution distribution test is feasible in SPES facility, with the boundary conditions specified.

In addition, some requirements for the SPES measurement system have been identified: the facility must be equipped with boron concentration and mass flow rate measurement devices in order to conduct the experimental test and provide meaningful information for the subsequent analysis.

The report contains the description of the PKL test facility and of the selected test, the description of the SPES test facility. Section 4 is dedicated to the description of the adopted code and

nodalization and it is followed by the description of the test to be carried out in SPES and its objective. The results of the calculations are reported in section 6. The activity includes also some suggestion to improve the measurement system of the SPES facility. Finally, conclusions are reported in the last section.

2. Description of the PKL facility and the experiment

2.1. PKL facility

The PKL facility is full high ITF (elevations scaled 1:1), shown in Figure 1 that models the entire primary system and most of the secondary system (except turbine and condenser) of a 1300-MW PWR NPP. It has been used for extensive experimental investigations on the study of the integral behavior of PWR NPP accident conditions (PKL is a German acronym for "Primary System"). Different test programs have been carried out with the PKL facility: PKL I and II test programs (1977 - 1986) focused on LBLOCA and SBLOCA and the PKL III test program (starting from 1986) addressed on the simulation of accident sequences, mainly on the BDBA and the issues related to the day-to-day operation of Siemens-built PWR [1].

The PKL facility has been designed using the specific data of Philippsburg NPP unit 2, and the scaling concepts to simulate overall thermal hydraulic behavior of the full-scale power plant.

The following features can be highlighted:

- full-scale hydrostatic head;
- power, volume, and cross-sectional area scaling factor of 1:145;
- full-scale frictional pressure loss for single-phase flow;
- simulation of all four loops;
- core and SG have full-scale rod and U-tube dimensions, spacers, heat storage capacity but the numbers of rods and tubes are scaled down;
- the simulation of phenomena are priority objective compared with the consistent simulation of the geometry, (e.g., in order to account for important phenomena in the hot legs such as flow separation and countercurrent flow limitation – CCFL -, the geometry of the hot legs is based on conservation of the Froude number and was finally designed on the basis of experiments at the full scale UPTF);
- the configuration of the RPV DC, modeled as two stand pipes connected to the lower plenum and as an annulus in the upper region, allows the frictional pressure losses preservation and a reasonable volume/surface ratio distortion;
- the operating pressure of the PKL facility is limited to 45 bar on the primary side and to 56 bar on the secondary side. This allows simulation over a wide temperature range (250°C to 50°C) that is particularly applicable to the cool-down procedures investigated.

Table 1 gives general information concerning the involved system and support the facility description hereafter. For sake of completeness the data of other PWR test facilities (LOBI, SPES, BETHSY and LSTF) are also reported.

The PKL test facility is subdivided into RCS, SG SS, the interfacing systems on the primary and secondary side and the break.

RCS comprises the vessel, the four loops (pipes, pumps and steam generators), and the pressurizer (PRZ) connected via the surge line to the loop #2.

The vessel models the following:

- The upper head plenum is a cylinder, full scale in height and 1:145 in volume. It contains the shaft of the RPV liquid level detector and in the bottom houses the top plate, the upper core support and the control rod guide assemblies.
- The upper plenum is full scale in height and scaled down in volume. The internals are simulated by means of seal-welded tube.
- The upper head bypass is modeled by four lines associated with the respective loops to enable detection of asymmetric flow phenomena in the RCS (e.g., single-loop operation).
- The reactor core model consists of 314 electrically heated fuel rods (diameter 10.75 mm and pitch 14.3 mm) and 26 control rod guide thimbles (diameter 13.6 mm). Three concentric zones can be heated independently and simulate a radially variable power profile. The maximum electrical power of the test bundle is 2512 kW distributed as follows: 504 kW in the inner zone (63 rods with 8 kW each one); 944 kW in the central zone (118 rods with 8 kW each one) and 1064 in the outer zone (133 rods with 8 kW each one). Thermocouples are located in the rod bundle for measuring the rod temperatures.
- The reflector gap is between the rod bundle vessel and the bundle wrapper (the barrel in the real plant). Following the reference plant, the flow resistance has been designed in order to have 1% of the total primary side mass flow (with MCP in operation) across the reflector gap. In this zone are also located 2 concentric 1.5 mm thick nickel sheets with the function to protect the rod bundle vessel against overheating (max allowable temperature is 300°C).
- The lower plenum contains the 314 extension tubes connected with the heated rods. The down-comer pipes are welded on the lower plenum bottom in diametrically opposite position. Two plates are located in this zone: the Fuel Assembly Bottom Fitting and the Flow Distribution Plate.
- The down-comer is modeled as an annulus in the upper region and continues as two stand pipes connected to the lower plenum. This configuration, as already mentioned above, permits symmetrical connection of the 4 CL to the RPV, preserves the frictional pressure losses and does not unacceptably distort the volume/surface ratio. The hydraulic diameter of the down-comer vessel is equal to that of the reactor down-comer. The down-comer pipes simulate the lower portion of the reactor down-comer and the diameter is equal to the hydraulic diameter of the annular down-comer in the prototype reactor.

The facility has four loops; each one is constituted by a hot leg, a U-tube SG (primary side), a loop seal, a main circulation pump and a cold leg. The hot legs have been designed taking into account the relevance of an accurate simulation of the two phase flow phenomena, in particular CCFL, in the hot leg piping as in the reactor. For these reason the hot leg has the scaled diameter in the part flanged to the upper plenum and then a concentric increase from 80.8 mm to 154 mm upstream the connection to the SG inlet plenum. The cold legs connect the SG to the MCP through the loop seal and the MCP to the DC vessel. The hydrostatic elevations of the loop seals are 1:1 compared with the prototype NPP. The cold legs have also nozzles located between thee MCP and the DC vessel for the ECCS injection and two seats in CL 1 and 2 for the break simulation.

The PKL MCP are vertical single-stage centrifugal pumps, driven by variable-speed motors provided with anti-reverse rotation devices.

The PKL PRZ has full height and it is connected through the surge line to the hot leg #2. The electrical heaters and the water spray have been modeled in the water and steam plenum respectively.

The four SG (primary side) of the PKL Test Facility are vertical U-tube bundle heat exchangers like in the prototype NPP. The scaling factor has been preserved by reducing the number of tubes: 28 tubes with outside diameter of 22 mm and wall thickness of 1.2 mm. Seven different lengths are modeled with the shortest and the longest tubes that have the same height of the reactor SG.

The SG (secondary side) is constituted by the tube bundle zone where the interface between the RCS and secondary side occurs. Below the shortest tubes, seal welded hollow fillers allow to achieve the correct volumetric scaling of the SG secondary side. The DC model can be divided into three parts: the upper, located above the U-tube zone, is annular and contains the FW ring; the central, in the tube bundle zone, is modeled by two tubes outside of the SG housing; the lower has annular shape formed by a cylindrical shroud within the vessel. The flow distribution plate has been attached to the bottom of the shroud.

The uppermost part of the SG, the larger part of the SG vessel, models the steam plenum. The SG outlet nozzle has a restriction, like the prototype system, in order to reduce the blow-down rate in the MSLB events. Finally the moisture separator, the dryer and the perforate plate of the reactor SG have been simulated with a perforate plate, with appropriate flow resistance, located below the SG outlet nozzle. The condensate, formed in this plate, returns to the SG DC through a funnel place in the uppermost part of the SG below the perforate plate.

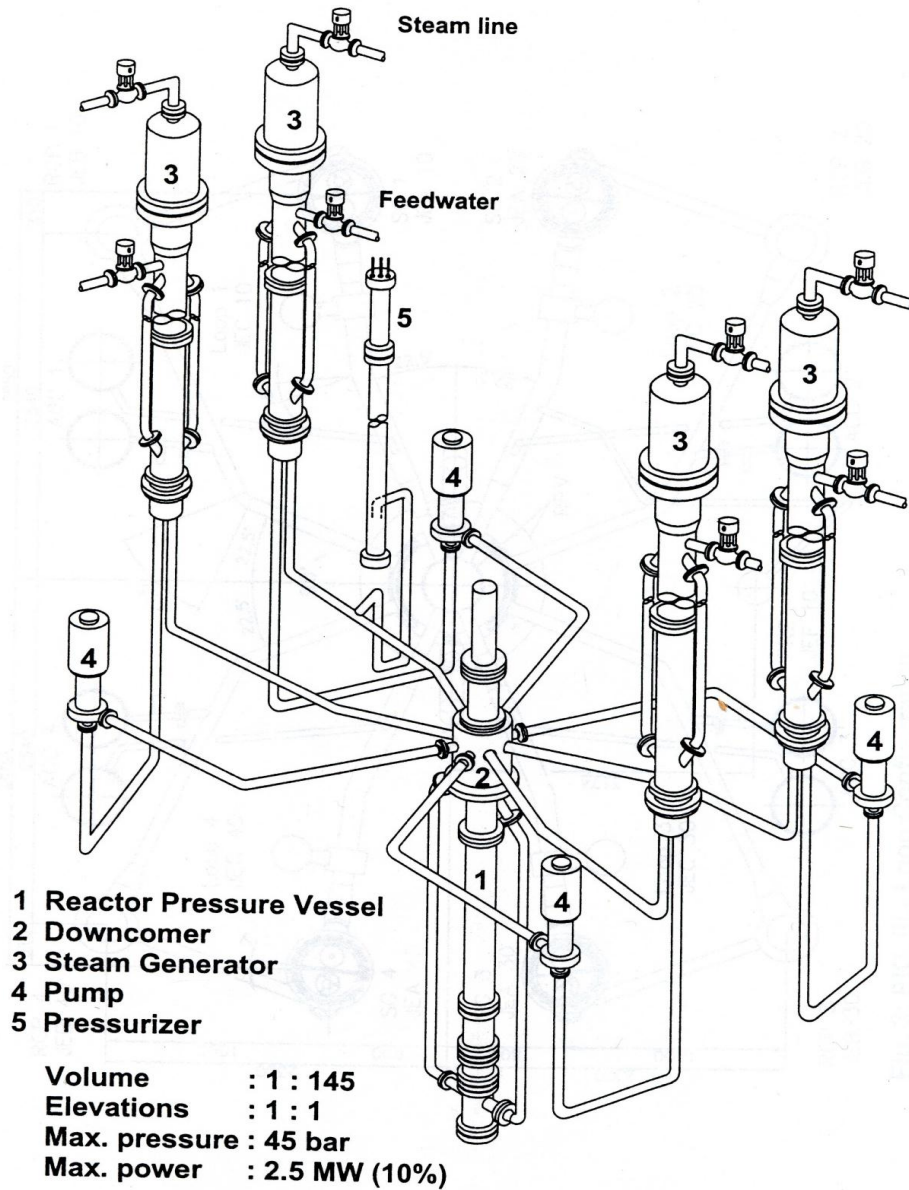

Fig. 2: PKL III - Test Facility (RCS)

Figure 1. PKL: general view of the facility

Parameters	Unit	PKL	LOBI	SPES	BETHSY	LSTF
Reference reactor or reactor		Siemens PWR 4-loop	KWU-PWR 4 loops	W-PWR 3 loops	FRA-PWR 3 loops	W-PWR 4 loops
Power of the reference reactor or reactor power	MWth	3765	3900	2775	2775	3423
Reported Kv		1/145	1/712	1/427	1/100	1/48
ITF number of loops		4	2	3	3	2
ITF nominal power	MWth	2.512	5.28	6.49	2.86	10.0
ITF volume (with PRZ)	m ³	3.282 ^(***)	0.648	0.624	2.88	7.952
ITF volume (without PRZ)	m ³	2.766 ^(***)	0.561	0.5286	2.473	6.805
Primary side fluid total mass (*) (^)	kg	-	436	423	1984	5404
Pressurizer nominal pressure	MPa	4.5 (**)	15.7	15.5	15.5	15.55
Inlet core mass flow rate (^)	Kg/s	-	3.5	4.25 *	17.5 **	48.4
Outlet core temperature (^)	K	-	589	589	588	589
Steam generator secondary side volume	m ³	5.824 ^(***)	il 0.7307 Bl 0.1648	1.163	1.952	4.842 4.742
Steam generator secondary side total mass (^)	Kg	-	Il 325 *** bl 115	182 *** 183 185.5	780.6 ***	2569.5 ***
Secondary side operating pressure	MPa	5.6 (**)	il 6.94 bl 6.91	6.94	6.80 6.84 6.84	7.0
PS Heat Losses	kW	90 ^(^^)	110	150	54.2	167

* value obtained from figure.

** calculated value.

*** value obtained from pre-test calculations

(*) excluding pressurizer

(**) Limit on the operator pressure

(***) Reference [2]

(^) This data is referred to the SBLOCA counterpart test (see reference [3])

(^^) Reference [4]

Note : all reported values refer to the experiments mentioned in the bottom line

Table 1. General data on PKL, LOBI, SPES, BETHSY and LSTF facilities

2.2. Test E2.2 description

The performed test investigates the boron dilution distribution in condition of reduced mass inventory (e.g. SB-LOCA event). The boron dilution takes place when conditions for reflux-condenser phenomenon are established in the plant. This phenomenon produces de-borated water plug in the primary circuit namely in the loop seals. The test OECD-PKL E2.2 [5] has been designed to investigate the boron distribution inside the facility during the asymmetric ECCS injection (HPIS and LPIS in loop 1 and 2) and the following filling up of the facility.

The main relevant aspect of the test is constituted by boron distribution in the facility during the transition between the reflux-condenser conditions to natural circulation conditions particularly paying attention to the low borated slug of water accumulated in the loop seals.

The baseline conditions for test E2.2 (reflux-condenser conditions at high primary-side filling levels with condensate accumulations in the SG inlet channels and in the loop seals) are established in a conditioning phase.

Before the start of the conditioning phase, the test set-up except for the PRZ is completely filled with water with a homogenous boron concentration of 1000 ppm. The heater rod bundle power is 530 kW (decay heat level of 1.8%). At an RCS pressure of 42 bar, the core outlet temperature is 250°C. Heat is removed to the secondary side by sub-cooled natural circulation in all four loops. The main steam generator pressure is 28 bar. After building up the pressure in the secondary side, and having a RCS pressure of 44 bar, the break in cold leg 1 was opened (without feeding into the RCS) initiating TPNC. During this time, the RPV upper head voided rapidly; the PRZ and the SG drained. The main steam pressure is controlled so that the RCS pressure can be held at about 40 bar. However, the transportation of coolant, from the SG inlet side to the outlet side, does not stop up to the time of the fluid levels in the SG outlet dropped below the tube-sheets. At this time the break is closed again. A reflux-condenser condition prevails.

This condition is maintained for a period of time until the loop seals boron concentrations are < 50 ppm. An ECC injection (at a reduced rate) onset into cold legs 1 and 2 occurs even before SOT.

Thus, the initial state for test E2.2 is a partially drained reactor coolant system with symmetrical energy removal in the reflux-condenser mode via all four SG at a primary-side pressure of 40 bar. The boron concentration in the loop seals is less than 50 ppm, at the top edge of the core it is about 3600 ppm.

The test is initiated by opening the break (32 cm²/145) in CL 1 between the RCP and the RPV and commencing cool-down of the four SG at 100 K/h. At the same time, the core power is reduced from initially 530 kW (corresponding to a decay heat of 1.8 %) and the injection rates of the SIP on the cold sides of loops 1 and 2 are increased.

The RCS inventory initially drops at SOT: it passes through a minimum at which the SG tubes are completely drained for a time, before climbing again. At RCS pressure < 10 bar the low pressure safety injection (LPSI) pumps are activated and injection occurs (with boron concentration of 2200 ppm) into cold legs 1 and 2. The primary system is refilled. When the RCS pressure rises above 10 bar, the LPSI pumps are switched off. At ~6000 s the SIP are switched off. The test is concluded ~8000 s after SOT.

During refill by cold-side ECC injection, the hot-side coolant present (in the region of the core, the UP and the HL) has to be displaced towards the SG. Since very high boron concentrations are present, particularly in the core region, this displacement process is bound to raise the boron concentration in the components closer to the SG, too. The additional ECC injection accelerated the rise in the filling level. In all SG, the short U-tubes are refilled faster than the longer ones and the steam still being produced and flowing from the core to the SG tubes made the filling level in the SG swell.

In loop 1 with the cold-side break, a slow-moving through flow in forward direction through the SG has already started at time ~3300 s, however the mass flow initially remained below the detection threshold of the mass flow instrumentation. In loop 2, a slow-moving through flow has likewise set in at about the same time, which, however, alternated between forward and backward flow. The onset of circulation occurs in the unfed loops and it affects the boron concentration at the RPV inlet.

Between 4000 s and 5000 s after SOT, quasi-steady-state conditions have been observed in RCS. In 3 loops there is natural circulation, the steam in the RPV upper head is condensing slowly, the filling level in the PRZ is 5 m, and the RCS pressure is about 21 bar.

The boron concentration at the RPV inlet in CL 2 rises. Water with boron concentration of 2500 ppm is already present at the SG outlet and in the SG tubes. The under-borated water originally in loop 2 has been so thoroughly mixed with higher-borated water as a result of the alternating flow processes prevailing in loop 2 that by 6500 s at the latest there are no longer any measurable accumulations of low-borated water present. A similar rise in the boron concentration is also observed in loops 4 and 3. This rise can be explained by the fact that the water that has been in the core region and has been enriched with boron in the reflux-condenser phase is distributed to the hot legs during refill and then displaced further toward the SG, in some cases entering the U-tubes. The resumption of natural circulation then flushed these higher-borated water masses out of the SG and transported them through the loop seals and the cold legs into the RPV.

3. Description of the SPES facility

The SPES (Simulatore PWR per Esperienze di Sicurezza) Integral Test Facility, [6], is designed to simulate the whole primary circuit, the relevant parts of the secondary circuit (steam generator secondary sides, main feed water lines up to the isolation valves, main steam lines upstream the turbine valves), and the most significant auxiliary and emergency systems (charging and let-down system, safety injection system, including high pressure and low pressure system, accumulators, emergency feed water system, steam dump and so on) of the Italian Standard Nuclear power plant (PWR-PUN, Westinghouse 312 type, 3 loops, 2775 MWth core power).

The basic design choices of the facility are the following:

- three active loops to simulate a three loops reactor;
- design pressure 20 MPa, design temperature 910 K; this choice allows the execution of tests with primary pressure over the reactor design pressure (17.2 MPa);
- electrical heating of the power channel: 97 electrically heated rods, with uniform flux (local hot spots can be simulated by means of three rods with a peaking factor of 1.19);
- maximum channel power corresponding to about 140% of the reactor nominal power; this choice allows the simulation of reactor power excursions;
- volume scaling factor and power scaling factor (nominal power about 6.5 MW) equal to 1:427;
- height of all the components is the same as in real plant, except for the pressurizer which is shorter, in order to preserve the volume scaling ratio and to maintain at the same time an acceptable flow area.

A sketch of the primary and secondary loops is reported in Figure 2.

In the SPES rig 375 measurement points are available, providing a large set of both direct physical quantities (absolute and differential pressure, temperature, voltage, etc.) and derived physical quantities (void fraction, mass velocity, quality, etc.).

Various kinds of transducers are located in the SPES facility (thermocouples, heated thermocouples, pressure transmitters, differential pressure transmitters, densitometers, void fraction probes, Venturi tubes, turbines, catch tank), supplying the following parameters:

- temperature
- pressure
- differential pressure
- liquid level
- density
- void fraction

- velocity
- flow pattern
- fluid mass

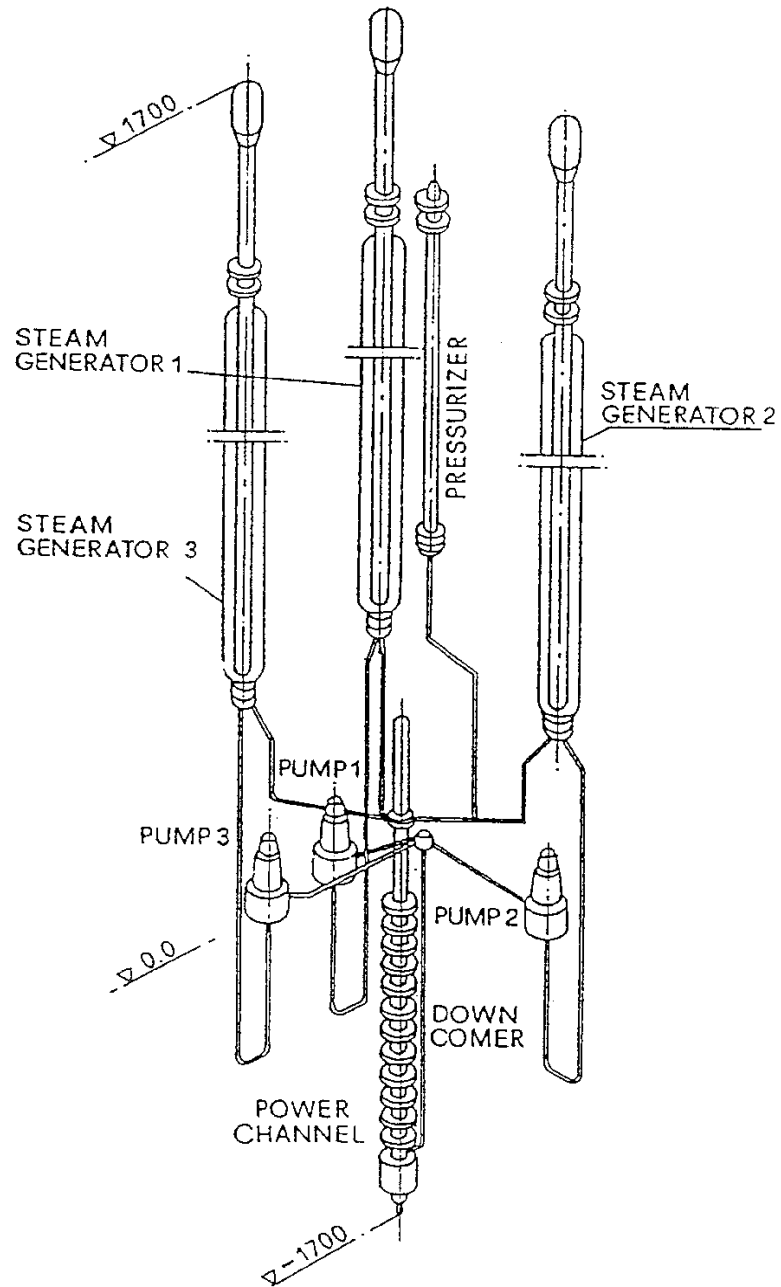

Figure 2. SPES system configuration

4. Adopted code and nodalization

4.1. RELAP5/Mod3.3 code

The light water reactor transient analysis code, RELAP5, was developed at the Idaho National Engineering Laboratory (INEL) for the U.S. Nuclear Regulatory Commission (NRC). Specific applications of the code have included simulations of transients in LWR system such as loss of coolant, anticipated transients without Scram (ATWS) and operational transients, such as loss of feed water, loss of offsite power, station blackout and turbine trip.

The Mod3 version of RELAP5 has been developed jointly by the NRC and a consortium consisted of several countries and domestic organizations that were members of the International Code Assessment and Application Program (ICAP) and its successor organization, Code Application and Maintenance Program (CAMP).

RELAP5/Mod3.3 code, [7], is based on a non-homogeneous, non-equilibrium set of six partial derivative balance equations for the steam and the liquid phase. A non-condensable component in the steam phase and a non-volatile component (boron) in the liquid phase can be treated by the code. A fast, partially implicit numeric scheme is used to solve the equations inside control volumes connected by junctions.

In particular, the control volume has a direction associated with it that is positive from the inlet to the outlet. The fluid scalar properties, such as pressure, energy, density and void fraction, are represented by the average fluid condition and are viewed as being located at the control volume center. The fluid vector properties, i.e. velocities, are located at the junctions and are associated with mass and energy flow between control volumes. Control volumes are connected in series using junctions to represents flow paths.

Heat flow paths are also modeled in a one-dimensional sense, using a staggered mesh to calculate temperatures and heat flux vectors. The heat structure is thermally connected to the hydrodynamic control volumes through heat flux that is calculated using a boiling heat transfer formulation. The heat structures are used to simulate pipe walls, heater elements, nuclear fuel pills and heat exchanger surfaces.

Two limits have fixed for the linear dimensions of nodes: all the volumes should have their flow lengths comprised between 0.5 and 1.0 m (with the exception of core stack, much more detailed, of the descending zone of the SG U-tubes and of the pressurizer and accumulator surge line, nodalized by 2.0 m length nodes). With regard to conduction heat transfer, the distance between neighboring mesh points inside structures must be less than 5 mm in each case, up to the lower limit of few tenths of mm used for heated rods and steam generator U-tubes. In the subdivision of volumes and slabs the position of instrumentation has been considered.

4.2. SPES nodalization description

For the present study the nodalization of SPES facility has been adopted which has been previously applied and qualified for the simulation of test SP-SB-04 performed at SPES facility [8].

The RELAP5/Mod3 nodalization for the SPES facility is shown in Figure 3. The correspondence between the zones of the facility and the nodes of the code model is presented in Table 2 and Table 3. In this table the facility is divided in zones, composed by various hydraulic elements. These components are reported in the table according to flow paths in nominal conditions. Number and type of the hydraulic nodes are indicated in the table itself.

The utilized code resources for the SPES nodalization are summarized in Table 4. In particular, the numbers of hydraulic components and of heat structure are reported.

Hereafter some significant aspects of the developed nodalization are summarized.

The vessel model consists of 45 hydraulic components which are connected through 48 junctions. The heat structures used in the vessel model are made up of 78 heat slabs subdivided in:

- 24 active structures for the heaters exchanging heat with the pipe component 130 (composed by 12 volumes), where the overall power is dissipated: two stacks of 12 slabs simulate the three hot rods and the remaining 94 rods of the core bundle;
- 4 internal non-active structures simulate the connection zones (in the lower part and in the upper part of the bundle) exchanging heat with the branch components 100-01, 110-01, 120-01 and 140-01, where no power is assumed to be dissipated;
- 50 heat slabs simulate the vessel structures; in 19 over 50 slabs the heat exchange with the environment is imposed.

In the vessel model all the bypass flow paths reported in the facility description have been modeled:

- bypass from lower plenum to upper plenum simulated by the pipe components 112 and 114 connected through the single junction 113;
- bypass from downcomer top to upper head simulated by the pipe component 145 and the single junction 155.

The three loops are almost equal in the nodalization (33 volumes, 32 junctions and 42 slabs) and are differentiated for the pressurizer (placed in loop 2). For simplicity the loop 3 is not shown in Figure 3, it has the same features of the loop 1.

The steam generator U-tubes are modeled asymmetrically, assuming that the largest portion of the exchanged power between primary and secondary side occurs across the slabs of the rising part of the package.

The pumps in the three loops are considered equal; different working conditions are achieved by changing the shaft velocity. The related input two phase curve differences, which for completeness have been considered in the nodalization, have been set equal to ones related to the LOBI/Mod2 pumps.

Two additional systems can be noted in the pressurizer nodalization:

- a time dependent volume and related trip valve (component 60-01 and 65-01 respectively);
- a time dependent junction and related time dependent volume (components 45-01 and 40-01 respectively).

Both are control systems. The former system allows the primary side pressure to remain constant in the steady-state period. The latter system maintains at an assigned value the liquid level inside the pressurizer. The temperature of the fluid possibly injected by this system corresponds to the saturation conditions inside the pressurizer.

Still, the block structures inside the pressurizer model represent the internal heaters; they simulate in the code model also the external heaters installed in the facility. The motor valve 75 and the related time dependent volume 70-01, connected to the top of the pressurizer, simulate the PORV system.

The secondary side nodalization of the three steam generators are equal both concerning the hardware of the facility and the control systems (33 nodes, 34 junctions and 25 head slabs): in particular the volume identification number can be obtained by changing the first digit in the loop 1 related one (6 in place of 5 for loop 2 and 7 for loop 3). Thus, only one nodalization will be described hereafter. Five zones can be recognized in each steam generator:

- the downcomer, consisting of a single stack of nodes (the two external downcomers are gathered in a single pipe component);
- the riser zone, essentially including the U-tubes;
- the top of the vessel, including the separator, the dryer and the steam dome regions;
- the steam line downstream the dome of each SG, simulated with the pipe component 525-01, the motor valve 580 and the time dependent volume 581. This last component is also utilized like a pressure control volume imposing constant pressure in the volume itself;
- the feedwater line connected to the top the downcomer, simulated with the pipe component 565-01, the time dependent junction 591 and the time dependent volume 590.

GENERAL ZONE	NAME	NUMBER	TYPE
PRESSURE VESSEL	DOWNCOMER REGION	135	BRANCH
		125	BRANCH
		115	PIPE
		105	BRANCH
	LOWER PLENUM	100	BRANCH
		110	BRANCH
		120	BRANCH
	LP-UP BYPASS	112	PIPE
		113	SNGLJUN
		114	PIPE
	CORE REGION	130	PIPE
		140	BRANCH
	UPPER PLENUM	150	BRANCH
		160	BRANCH
	UPPER HEAD	170	BRANCH
		180	BRANCH
		190	PIPE
	DC-UH BYPASS	155	SNGLJUN
		145	PIPE
	LOOP 1	VESSEL NOZZLE	200 (300) [400]
HOTLEG		210 (310) [410]	BRANCH
SG INLET PIPE		220 (320) [420]	PIPE
SG INLET JUNCTION		225 (325) [425]	SNGLJUN
SG OUTLET JUNCTION		235(335)[435]	SNGLJUN
SG OUTLET PIPE		240 (340) [440]	PIPE
LOOP		250 (350) [450]	BRANCH
		260 (360) [460]	PIPE
PRIM. COOLANT PUMP		270 (370) [470]	PUMP
COLD LEG		280 (380) [480]	BRANCH
	290 (390) [490]	BRANCH	
PRESSURIZER	SURGE LINE	010	PIPE
	PRESSURIZER VESSEL	015	BRANCH
		020	BRANCH
		025	PIPE
		030	BRANCH
		035	BRANCH
	PRZ LEVEL	045	TMDPJUN
		040	TMDPVOL
	PRZ PRESSURE CONTROL	065	TRPVLV
		060	TMDPVOL
	PORV	075	MTRVLV
		070	TMDPVOL
	PRESSURIZER LEAK	085	TMDPJUN
		080	TMDPVOL

Table 2. SPES nodalization: Correspondences Between Nodes and Hydraulic Zones (part1)

GENERAL ZONE	NAME	NUMBER	TYPE
SG1 (2) [3] SECONDARY SIDE	U -TUBE	230 (330) [430]	PIPE
	RISER	500 (600) [700]	PIPE
	UPPER PLENUM	505 (605) [705]	BRANCH
	SEPARATORS	510 (610) [710]	SEPARATR
	STEAM DOME	520 (620) [700]	BRANCH
	DOWNCOMER	530 (630) [730]	BRANCH
		540 (640) [700]	BRANCH
		560 (660) [760]	BRANCH
		570 (670) [770]	PIPE
	DC-RISER CONNECTION	575 (675) [775]	SNGLJUN
	FEEDWATER LINE	590 (690) [790]	TMDPVOL
		591 (691) [791]	TMDPJUN
		565 (665) [765]	PIPE
	EFW SYSTEM	592 (692) [792]	TMDPVOL
		593 (693) [793]	TMDPJUN
	TRANSIENT STEAM LINE	581 (681) [781]	TMDPVOL
		580 (680) [780]	MTRVLV
		525 (625) [725]	PIPE
	STEADY - STATE STEAM LINE	582 (682) [782]	TMDPJUN
		583 (683) [783]	TMDPVOL
	LEVEL CONTROL SYSTEM	594 (694) [794]	TMDPVOL
		595 (695) [795]	TMDPJUN
		596 (696) [796]	TMDPVOL
		597 (697) [797]	TMDPJUN
	SAFETY RELIEF VALVE	585 (685) [785]	TMDPVOL
		584 (684) [784]	MTRVLV
	SG LEAK	586 (686) [786]	TMDPVOL
587 (687) [787]		MTRVLV	
BREAK	BREAK VALVE	(383)	TRPVLV
	BREAK VOLUME	(384)	TMDPVOL
LPIS	LPIS JUNCTION	278 [478]	TMDPJUN
	LPIS TANK	277 [477]	TMDPVOL
ACCUMULATOR	ACCUMULATOR VALVE	281 [481]	MTRVLV
	ACCUMULATOR INJ LINE	282 [482]	PIPE
	ACCUMULATOR	284 [484]	ACC

Table 3. SPES nodalization: Correspondences Between Nodes and Hydraulic Zones (part2)

PARAMETER	VALUE
1. Number of Nodes	
- primary side	165
- secondary side	99
- total	264
2. Number of Junctions	
- primary side	169
- secondary side	102
- total	271
3. Number of Slabs	
- primary side	224
- secondary side	75
- total	299
4. Overall Number of Mesh Points	1615
5. Number of Core Active Structures	24
6. Heat Transfer Area (m ²)	
- core region	10.596
- steam generator U-tubes	35.417
7. Number of Mesh Points	
- core slabs	240
- steam generator slabs	351
8. Bypass Flow Paths	
Lower Plenum - Upper Plenum	
- area (m ²)	$1.441 \cdot 10^{-3}$
- total energy loss coefficient [$\sum K_i$ (forward)/ $\sum K_i$ (reverse)]	82/13.5
Downcomer - Upper Head	
- area (m ²)	$4.638 \cdot 10^{-3}$
- total energy loss coefficient [$\sum K_i$ (forward)/ $\sum K_i$ (reverse)]	3.5/3.5
9. Overall Volume (m ³)	0.622

Table 4. SPES Nodalization Code Resources

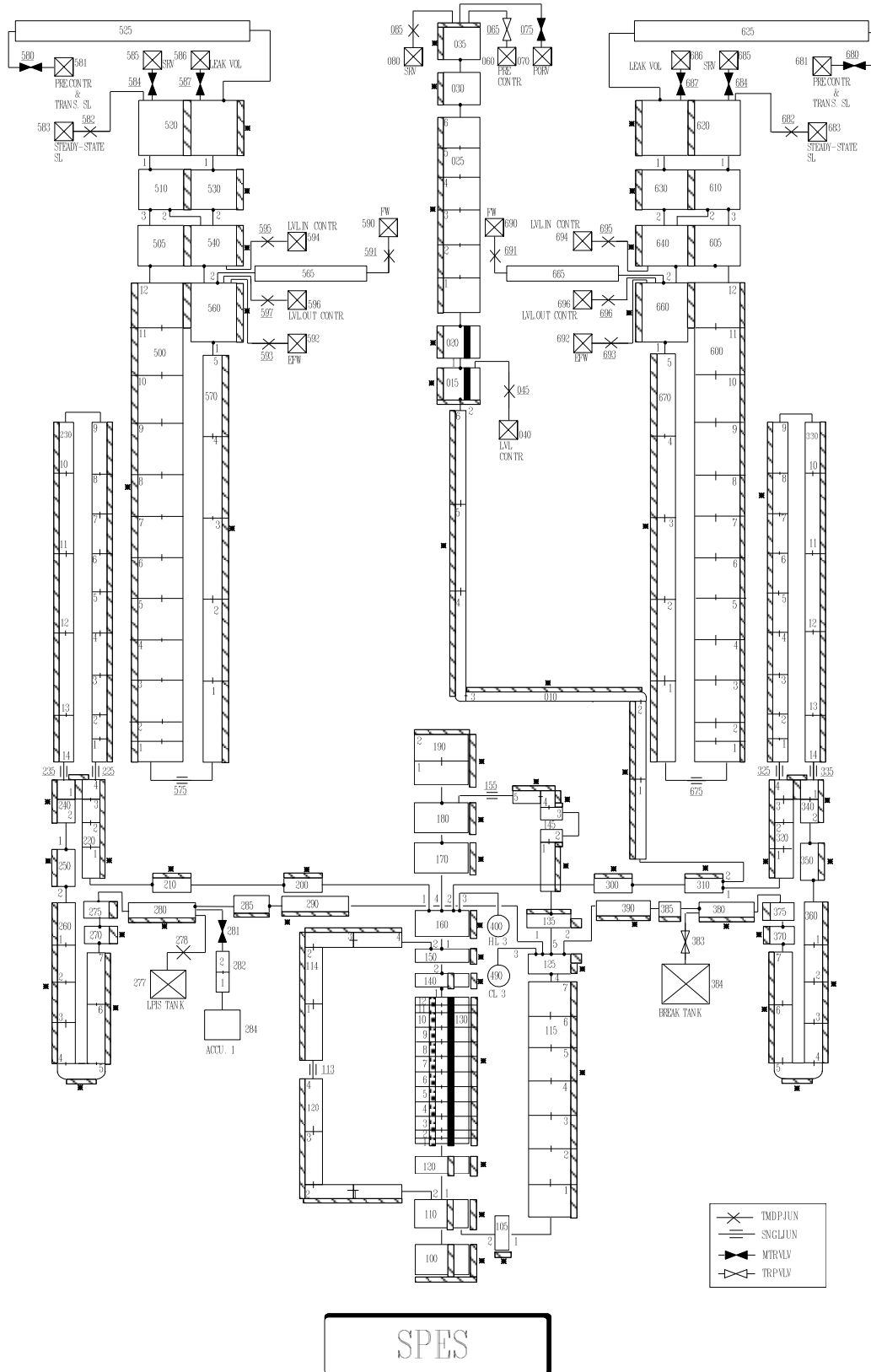

Figure 3. SPES facility nodalization for RELAP5 code

The degree of detail of the nodalization is commensurate to what considered in the primary loop. In particular, the heights of the riser volumes are the same as the minimum between the heights of the rising and descending corresponding nodes of the primary side U-tubes.

The component 510-01 simulates the separator that is necessary in the code model in order to achieve quality equal to one in the steam dome.

The pre-heaters are not simulated in the code model.

A relatively large number of control volumes are connected with the steam generators; the following functions are accomplished:

- feedwater injection and steam line previously described;
- EFW injection: simulated with the time dependent volume 592 and with the time dependent junction 593 (used only in the steam generator of the loop 1);
- SRV safety system: simulated with the time dependent volume 585 (safety tank) and with the motor valve 584 (safety valve);
- liquid level control system: realized through two time dependent volume components (596 and 594), each one connected with one time dependent junction (597 and 595 respectively). This system assures constant value for steam generator downcomer liquid level during the steady-state period.

5. SPES test description and objectives

5.1. Conditioning phase

The objective of the conditioning phase to be performed at SPES facility is to obtain conditions corresponding to the SOT of test E2.2 of PKL: partially drained primary side with energy removal in the reflux-condenser mode at a primary-side pressure of 40.5 bar and condensate accumulations in the loop seals. The parameters describing the SOT state to be achieved are provided in the Table 5.

The proposed conditions in SPES prior to start of conditioning phase are the completely filled primary side at nominal pressure, reduced core power, low-flow in the loops (at reduced main circulating pumps velocity) and low pressure at the secondary side. Facility initial conditions are presented in the Table 6.

In order to reach the conditions of SOT, a 4.156 mm² break is opened in the CL of loop 2. After the primary pressure reaches 13 MPa setpoint, the scram is activated, thus reducing the core power to the decay heat level of 95.6 kW, and the MCP are tripped and followed by a short coastdown. Once the primary side mass inventory is reduced to 50% of its initial value, the break is closed and the facility is let to operate in reflux-condenser mode, building up the condensate in the loop seals. Once the boron concentration in the loop seals reached 50 ppm, the SOT is considered to be achieved and the conditioning phase is terminated. During entire conditioning phase the secondary side pressure and levels in SG are maintained constant. No ECC systems are put into operation. The boundary conditions are listed in Table 7.

#	CONDITION	VALUE	NOTE
1	U-Tubes filled with steam		reflux condenser conditions
2	Coolant inventory	50 %	
3	Boron concentration	< 50 ppm in LS > 4000 ppm in core outlet	
4	Core power	95.6 kW	
5	Primary side pressure	40.5 bar	
6	Coolant temperature at core outlet	251 °C	
7	Subcooling at core inlet	0 °C	
8	Flow rate in loops	-	No circulation in all the loops MCP stopped
9	Main steam pressure in SG secondary side	39.0 bar	maintained constant
10	Main steam temperature in SG secondary side	249 °C	
11	Collapsed level in SG secondary side	11.5 m	maintained constant

Table 5. Baseline conditions of SOT state

#	CONDITION	VALUE	NOTE
1	Core power	768 kW	reduced with respect to nominal
2	Primary side pressure	152 bar	
3	Coolant temperature at reactor inlet	243 °C	
4	Coolant temperature at reactor outlet	284 °C	
5	Boron concentration	1000 ppm	
6	Flow rate in loops	1.75 kg/s	
7	MCP velocity	389 rpm	reduced with respect to nominal
8	Pressurizer level	3.15 m	
9	Main steam pressure in SG secondary side	39 bar	
10	Collapsed level in SG secondary side	11.5 m	
11	Feedwater temperature	164 °C	

Table 6. SPES initial conditions prior to conditioning phase

#	CONDITION	VALUE	NOTE
1	Break Area	4.156 mm ²	CL loop 2
2	SCRAM occurrence	PS pressure < 13 MPa	setpoint
3	MCP trip	PS pressure < 13 MPa	setpoint
4	Break closure	PS Mass < 50%	setpoint
4	HPSI/LPSI/Accumulators intervention	NO	
5	Secondary side pressure	39 bar	maintained constant

Table 7. Conditioning phase boundary conditions

5.2. Test phase

Once the SOT conditions are achieved, the test phase procedure is started by

- reopening of the break in the CL of loop 2 (4.156 mm²);
- start of 100 K/h cooldown of all 3 SG-secondaries;
- start of the core power decrease (see below for details);
- start of HPSI injection into CL loop 1 (with boron concentration of 2200 ppm).

Further measures taken throughout the test are:

- start of LPSI to inject water (with boron concentration of 2200 ppm) into cold leg of loop 1 when primary side pressure is below 10 bar;
- stop of the HPSI at a secondary pressure lower than 2 bar.

The list of boundary conditions for the test phase is provided in the Table 8.

The secondary side pressure at cooldown measured in PKL facility has been applied as a boundary condition for the test phase in SPES facility (Figure 4). Core power, HPSI and LPSI injection rates measured in PKL facility has been scaled following the power-to-volume scaling approach [9], using the ratio of facilities volumes K_v as a scaling factor, and applied to the SPES test phase (Figure 5, Figure 6 and Figure 7).

#	CONDITION	VALUE	NOTE
1	Break Area	4.156 mm ²	CL loop 2
2	Secondary side pressure	100 K/h cooldown	PKL values applied. Figure 4
3	Core power	decay curve	PKL values scaled and applied. Figure 5
4	HPSI intervention	start at SOT	PKL values scaled and applied. Figure 6
4	LPSI intervention	at PS pressure < 10 bar	PKL values scaled and applied. Figure 7
5	SG collapsed level	11.5 m	maintained constant
6	End of transient	7500 s	

Table 8. Test phase boundary conditions

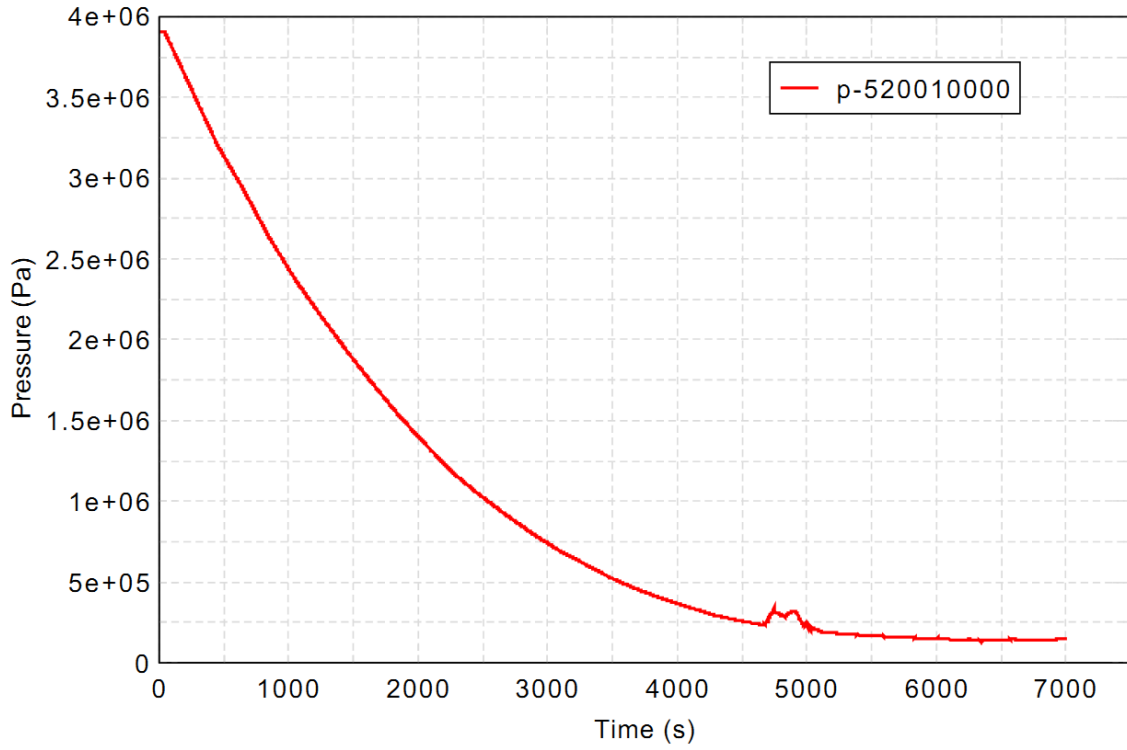

Figure 4. Test phase secondary side pressure

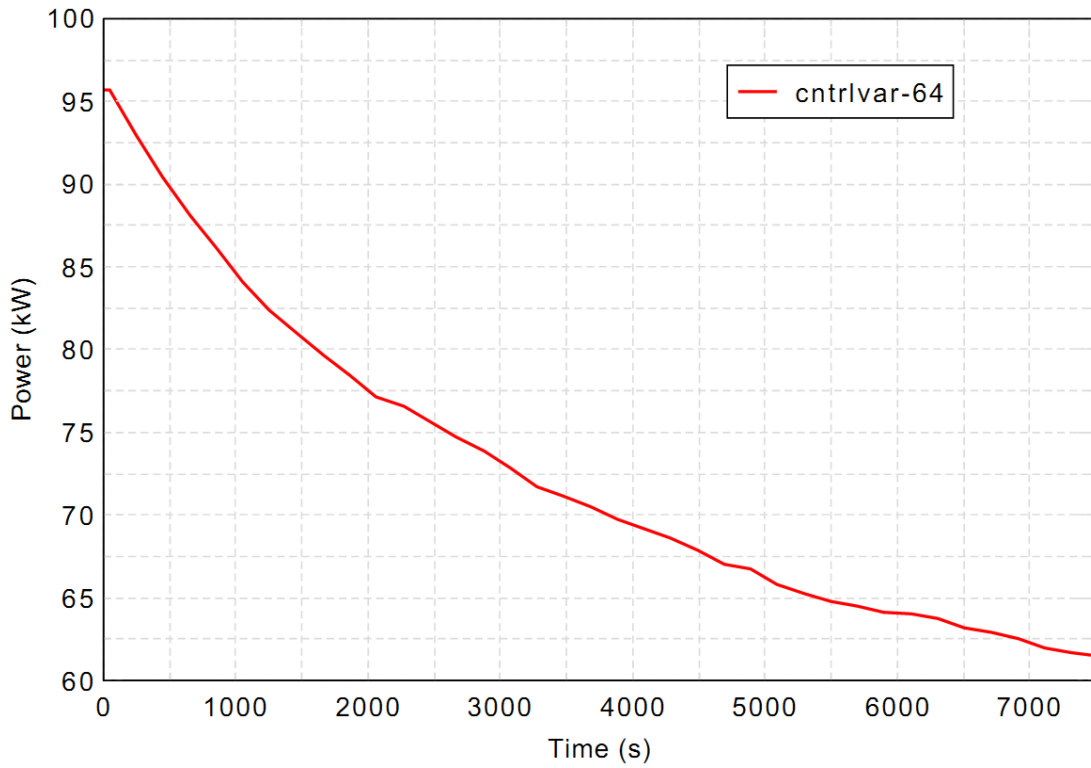

Figure 5. Test phase core power

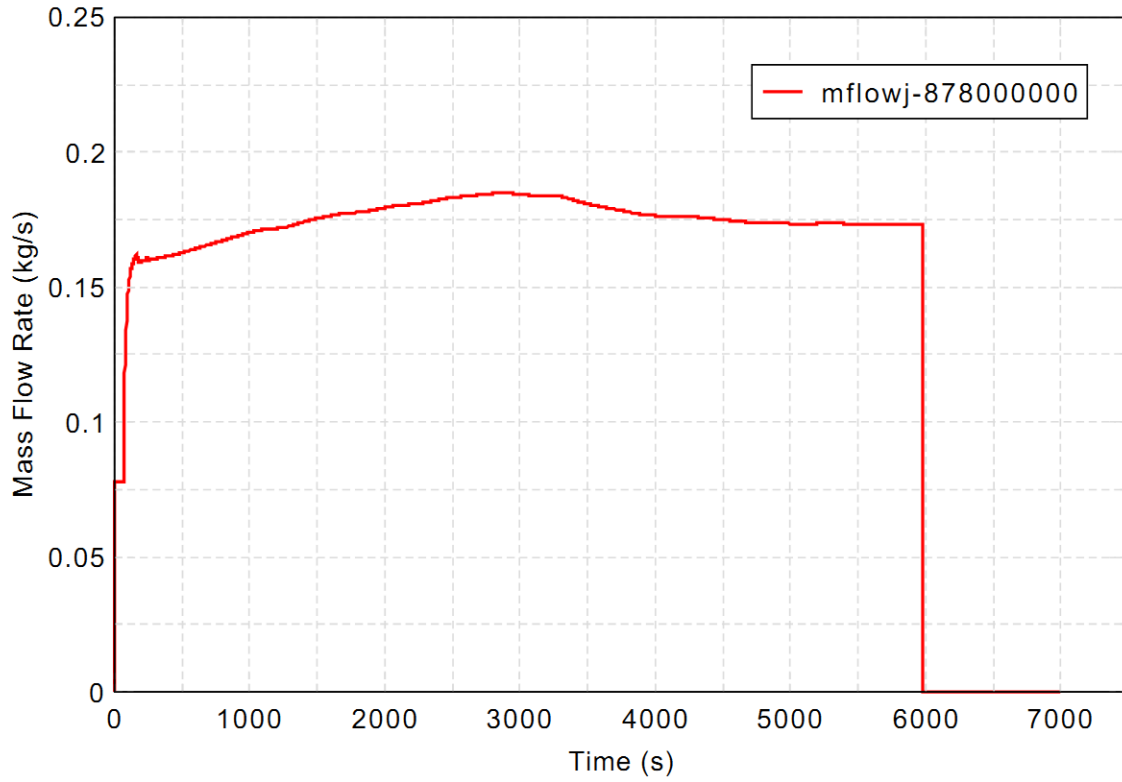

Figure 6. Test phase HPSI injection flowrate

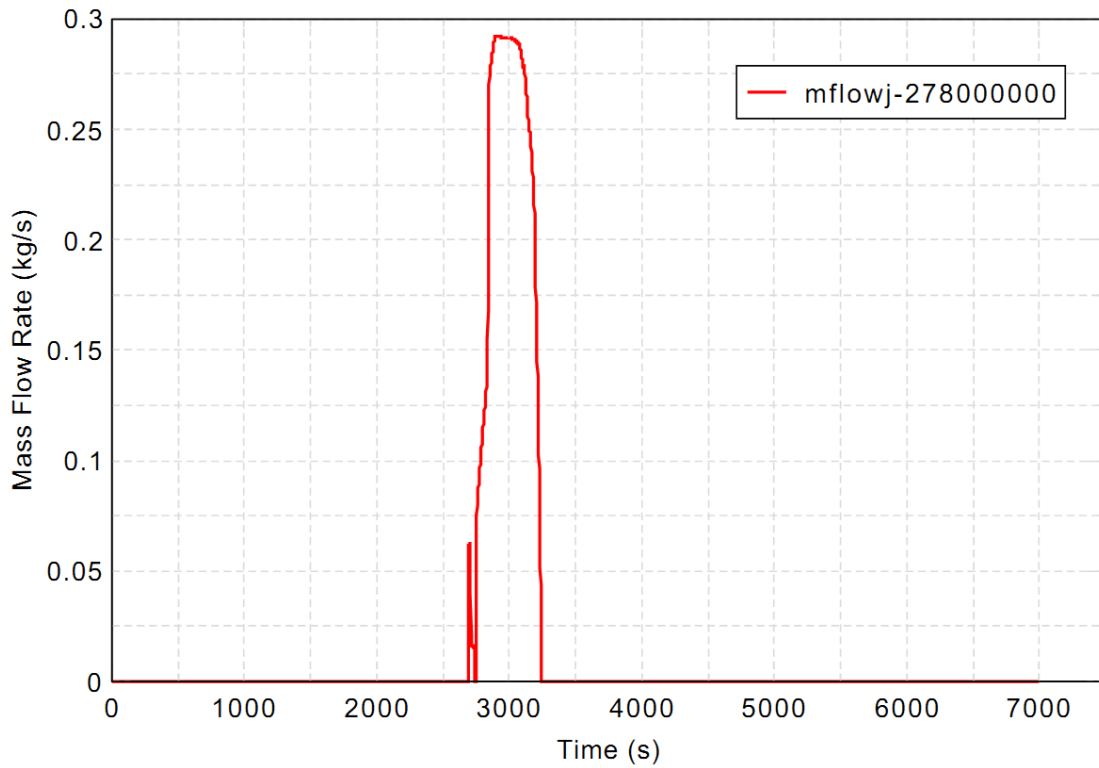

Figure 7. Test phase LPSI injection flowrate

6. Analysis of calculation results

6.1. Conditioning phase

Before commencing the calculation of conditioning phase, a steady-state has been achieved by running a 'null transient' of 100 s with parameters specified in Table 6. SPES initial conditions prior to conditioning phase. The model parameters were stable, i.e. solutions are stable with an inherent drift $< 1\% / 100$ s.

The break has been opened at -3300 s (the reference time 0.0 s has been assigned to SOT instant). The facility experienced an expected depressurization (Figure 8) which triggered the SCRAM and MCP trip at -3253 s. The PRZ is drained within 100 s after the opening of the break (Figure 9). The primary pressure continued to decrease until it is leveled with the constantly maintained secondary side pressure (Figure 10).

After the end of imposed MCP coastdown at -3240 s, the hot leg started to void, indicating the transition to the two-phase natural circulation in the loops which lasted until -2600 s. From that moment until the SOT the facility has been in the state of reflux-condenser mode with gradual build-up of deborated condensate in the loop seals.

At -2250 s the SG U-tubes are completely emptied, The break has been closed at -2175 s (1125 s after the start of conditioning phase) once the primary side mass decreased to 50% of its initial value (Figure 13).

Being in the reflux-condenser mode and, thus, building-up the condensate in the loop seals the boron concentration reaches 50 ppm by the time 0 s (Figure 14). The conditions of the SOT (Table 5) are met at the conditioning phase considered terminated.

It should be noted that although the obtained core inlet temperature matches the objective for SOT (0 °C subcooling), the fluid temperature at the inlet to the downcomer are rather low comparing to the PKL results. This may be caused by the effect that at stagnant conditions the fluid is overcooled by the overestimated/uncompensated heat losses. In the present study this is of no importance, although a detailed analysis of heat losses may be performed during the experiment technical specification program.

During the conditioning phase no dryout conditions and no increase of the heater rod temperature were observed in the core region.

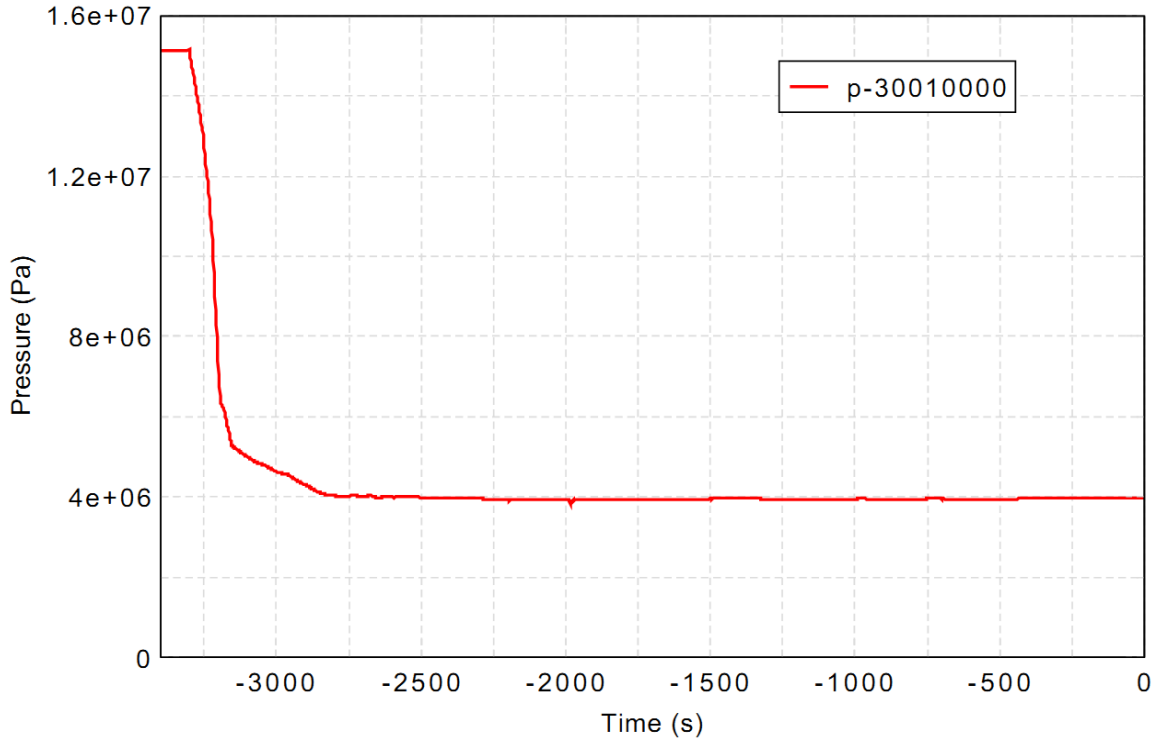

Figure 8. Conditioning phase: Primary side pressure

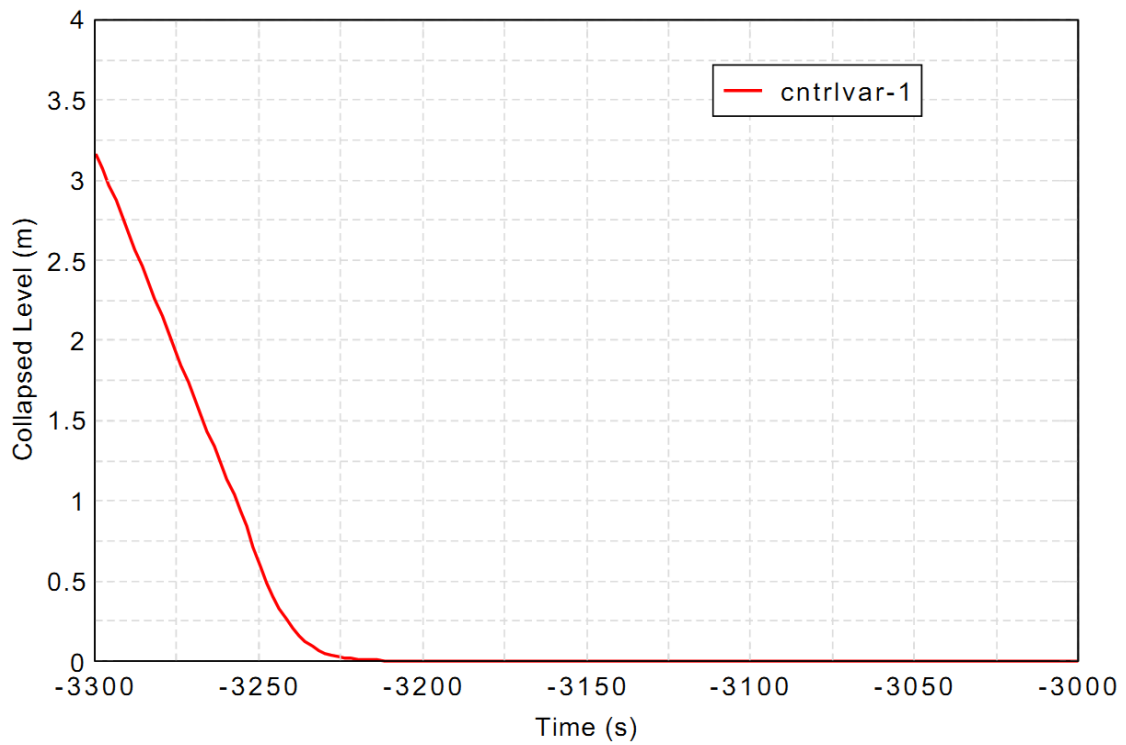

Figure 9. Conditioning phase: Pressurizer level

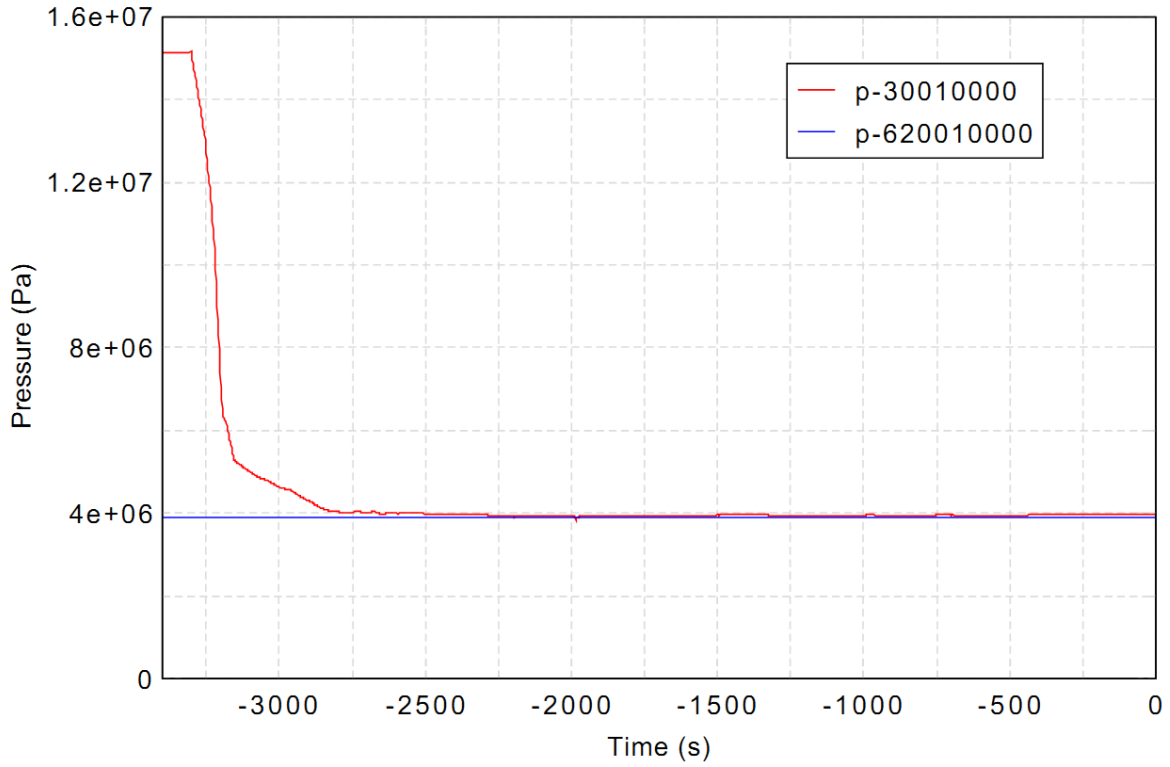

Figure 10. Conditioning phase: Primary side and secondary side pressure

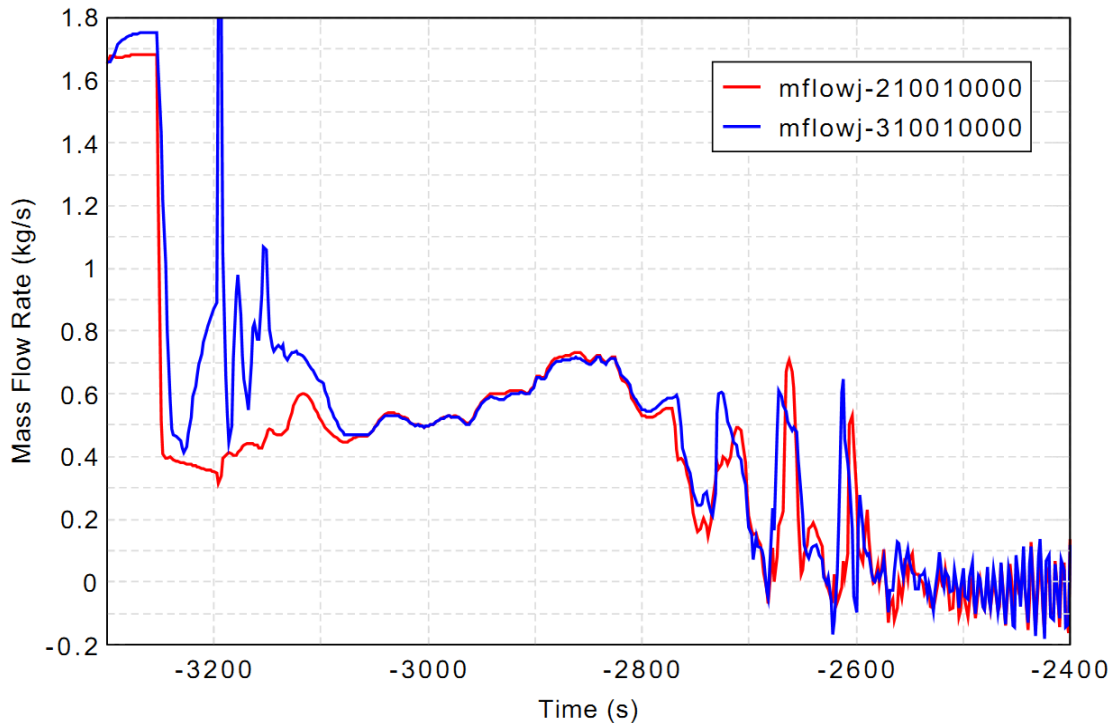

Figure 11. Conditioning phase: Mass flowrates in loop 1 and 2

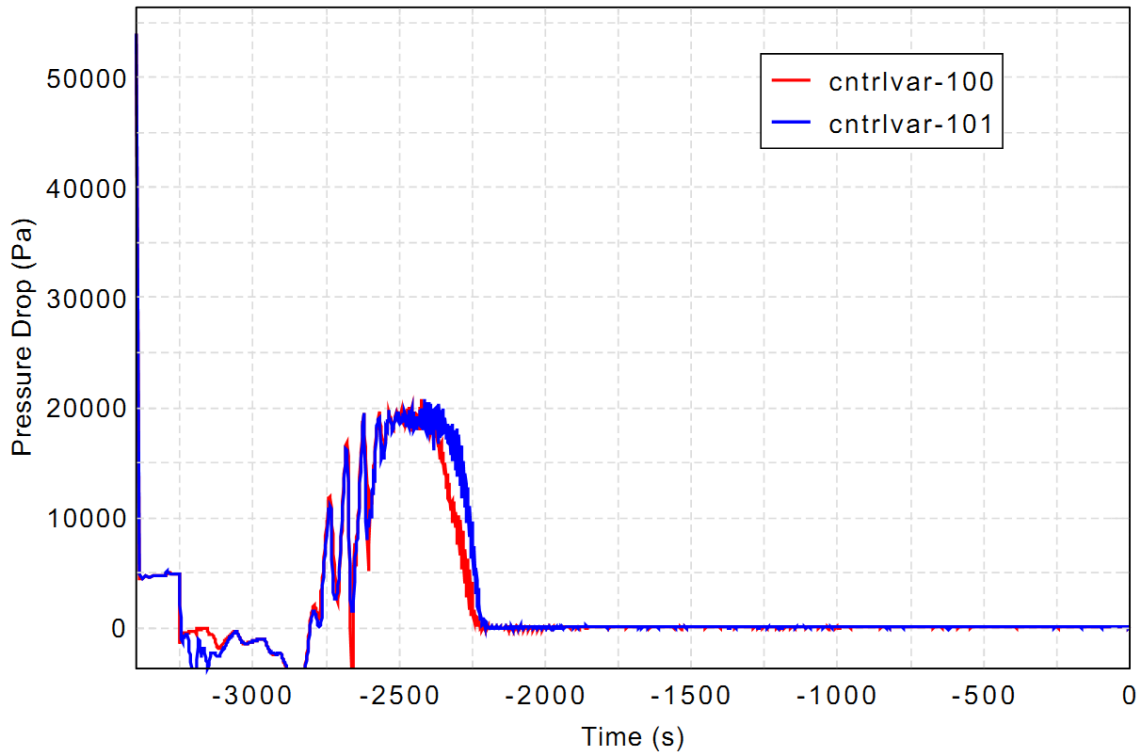

Figure 12. Conditioning phase: Pressure drop across U-tubes loops 1 and 2

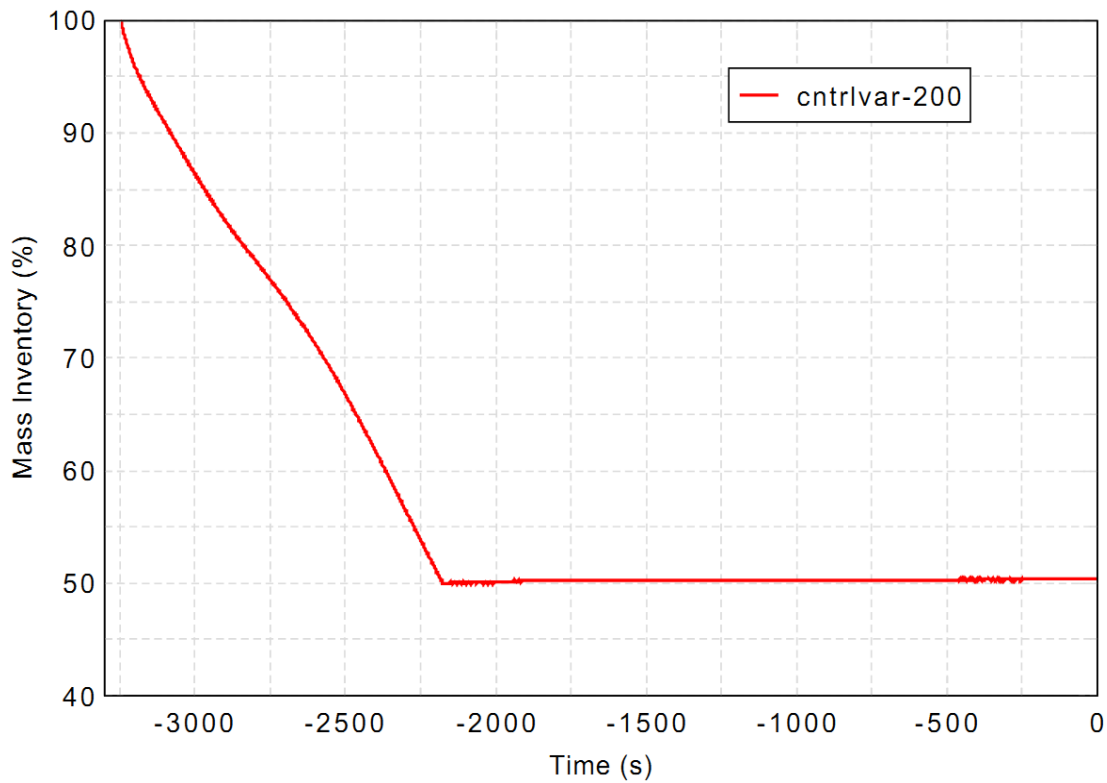

Figure 13. Conditioning phase: Primary side mass inventory

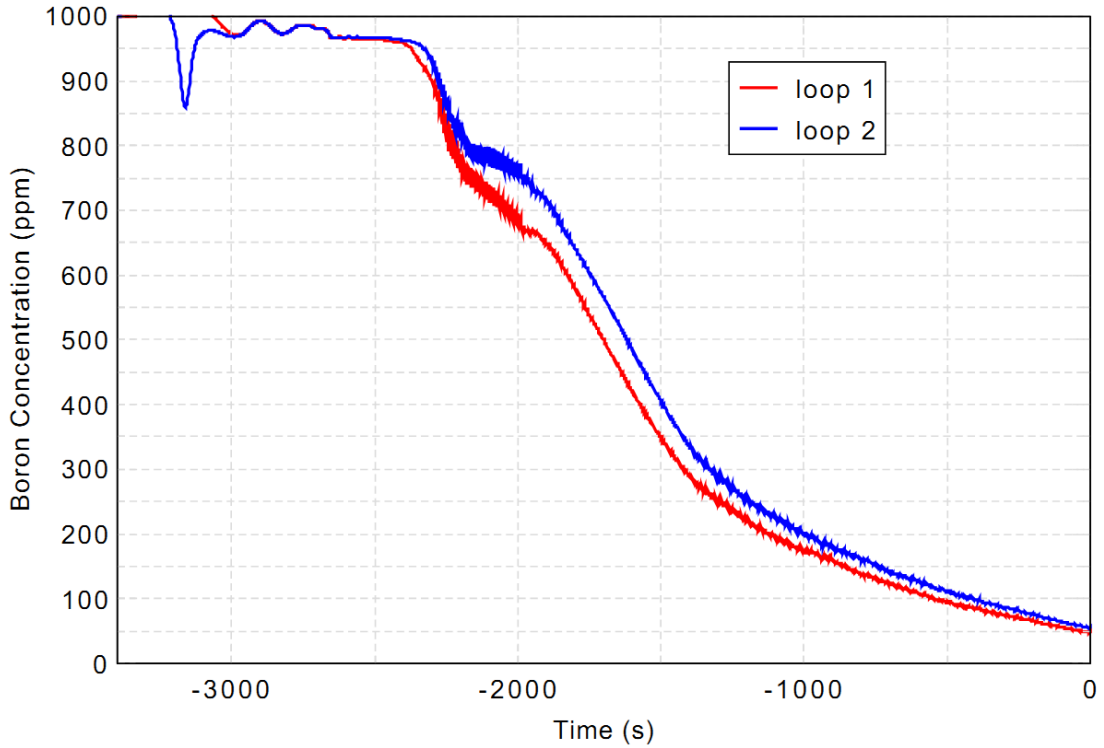

Figure 14. Conditioning phase: Boron concentration at loop seal bottom

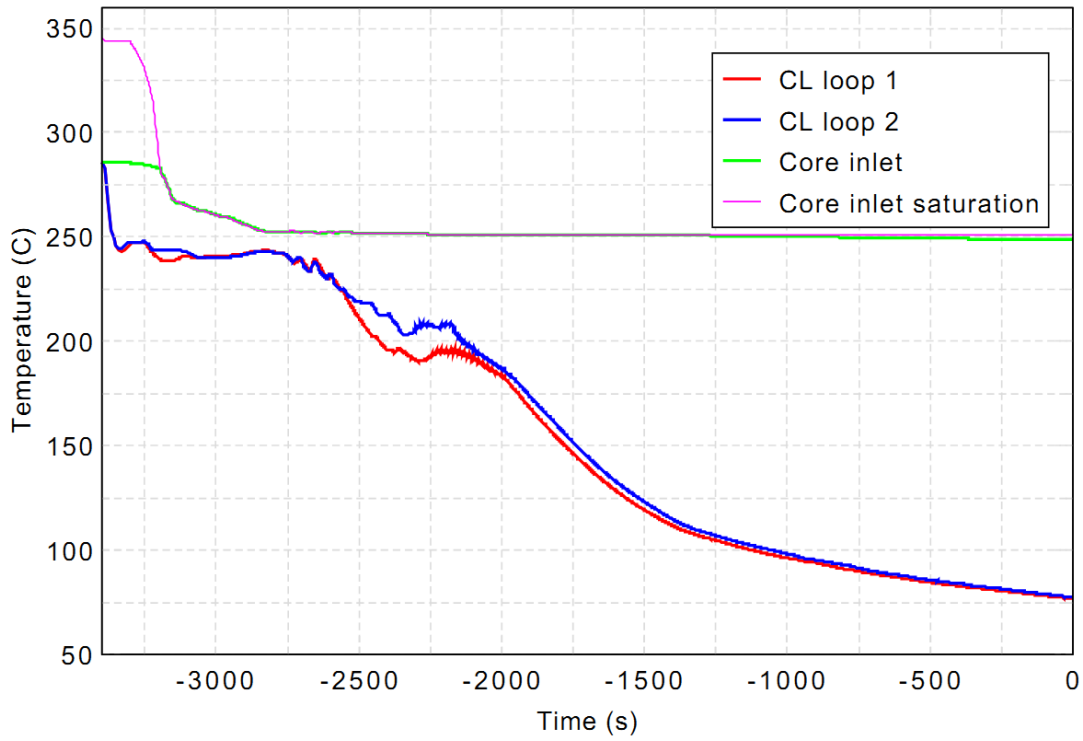

Figure 15. Conditioning phase: Fluid temperatures in primary system

6.2. Test phase

After the SOT conditions have been reached, the test phase is commenced by reopening the break in the cold leg of loop 2. The other boundary conditions have been implemented in the input deck using the following approach:

- Cooldown pressure curve (Figure 4) has been imposed at the outlet from SG by means of *time-dependent volume* component;
- The power trend (Figure 5) has been supplied in a form of tabular data;
- HPSI injection has been imposed as a mass flow rate through the *time-dependent junction* component in the loop 1 and has started from the time 0 s;
- LPSI injection has been imposed as a mass flow rate through the *time-dependent junction* component in the loop 1 with the onset of injection at primary pressure < 10 bar, which has effectively started at 2690 s;

After the opening of the break the primary side pressure started to decrease, following the cooldown curve of the secondary side, thus remaining coupled (Figure 16). The primary side continued to lose its mass inventory until it reached its minimum value 42% at 570 s (Figure 17). From then on, the primary mass was being recovered by ECC injection until the stop of HPSI at 5980 s.

The refill of the system led to the partial refill of the pressurizer (Figure 18) that caused the increase in primary pressure. As the ECC injection stopped, the PRZ emptied again and the primary pressure aligned with the secondary side pressure again.

The gradual recovery of the primary mass inventory led to the refill of SG U-tubes which was completed by 3600 s (Figure 19) and allowed the restart of the natural circulation in the loops at 3900 s (Figure 20). It should be noted that after the stop of ECC injection at 5980 s the natural circulation in broken loop 2 has ceased.

After the start of HPSI injection at 0 s into the CL loop 1 the boron concentration in the loops 1 and 2 started to increase - gradually in the loop seal (Figure 21) and sharply in the cold leg (Figure 22): in loop 1 due to the injected water and in loop 2 due to the reverse flow in the cold leg caused by open break. The unfed loop 3 shortly after the start of the test phase experiences the loop seal clearance and remains empty from 650 s until 1920 s. After the refill of this loop, the boron concentration in this loop levels up with the other loops at about 2000 ppm. The boron concentration in the lower plenum and lower part of the core inside the power channel increases initially after start of the test phase: partially due to the water delivery by HPSI and partially due to the reverse flow of the highly-borated water from top part of the core and hot legs.

The test phase considered terminated at 7000 s with refilled facility at natural circulation conditions and average boron concentration 2200 ppm and secondary side pressure about 1.4 bar.

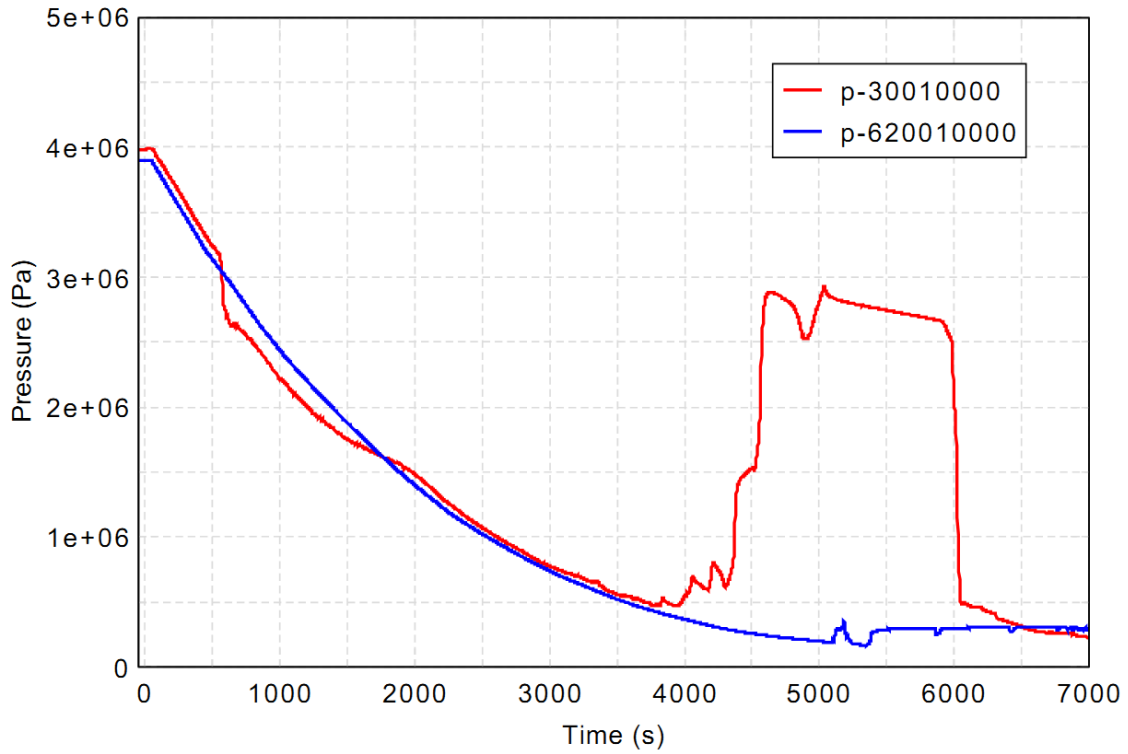

Figure 16. Test phase: Primary side and secondary side pressure

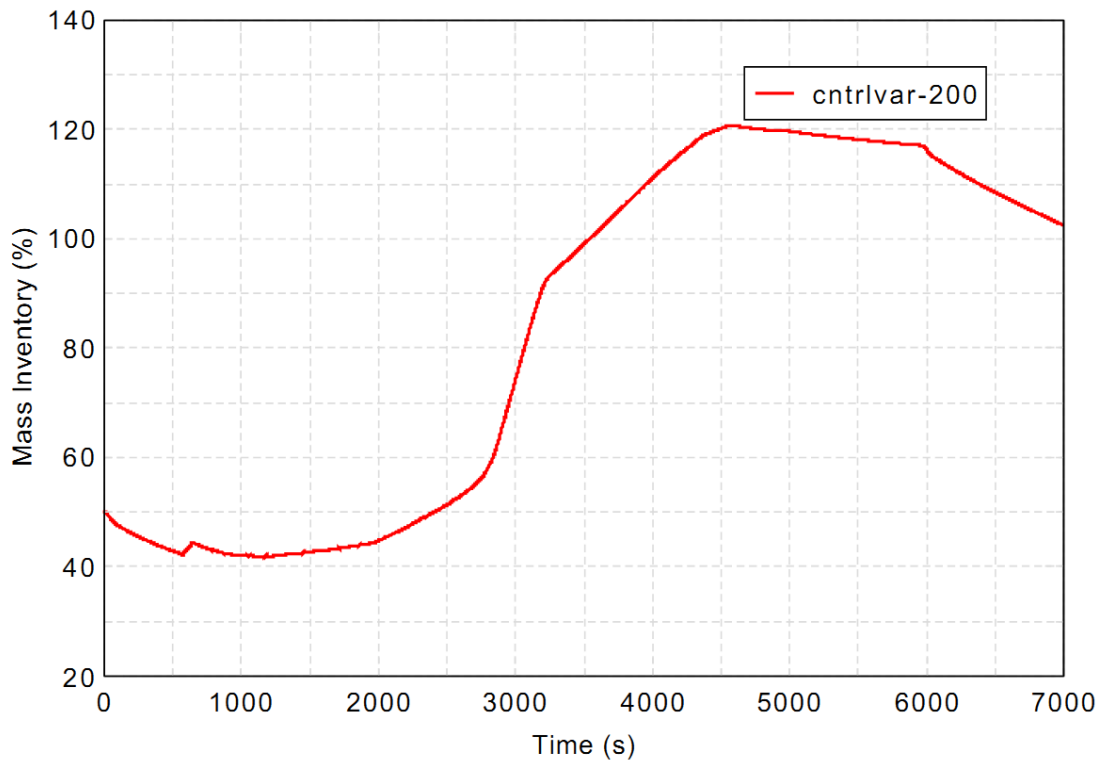

Figure 17. Test phase: Primary side mass inventory

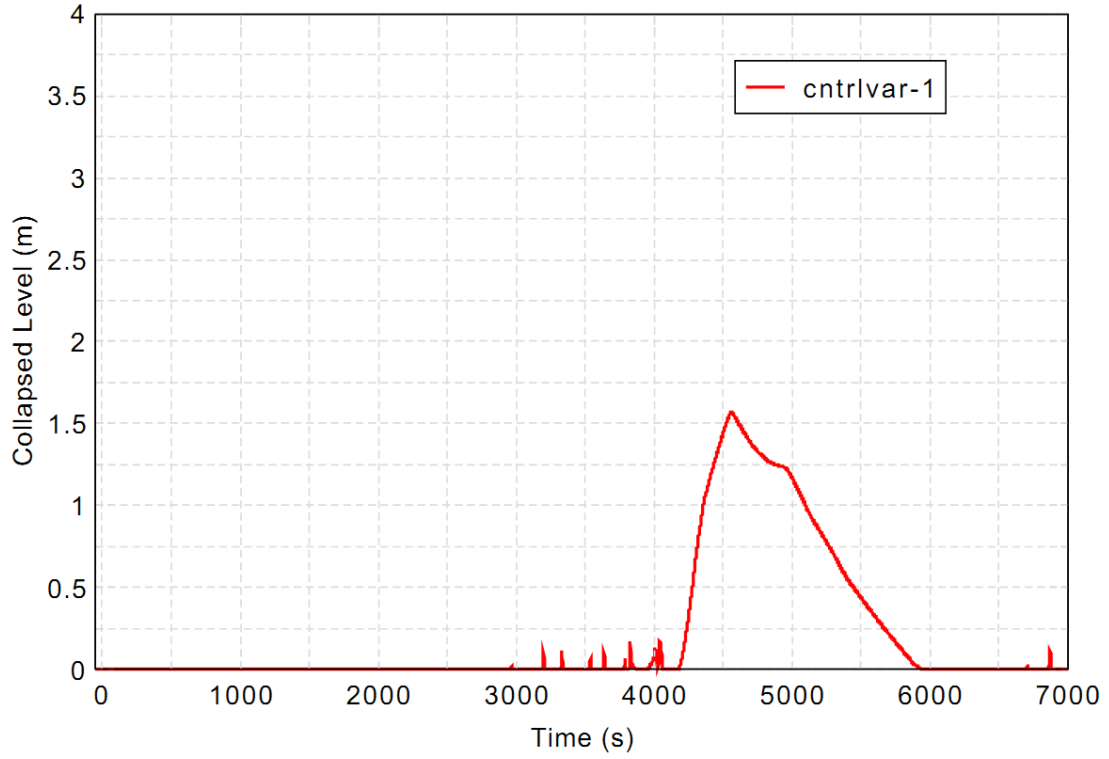

Figure 18. Test phase: Pressurizer level

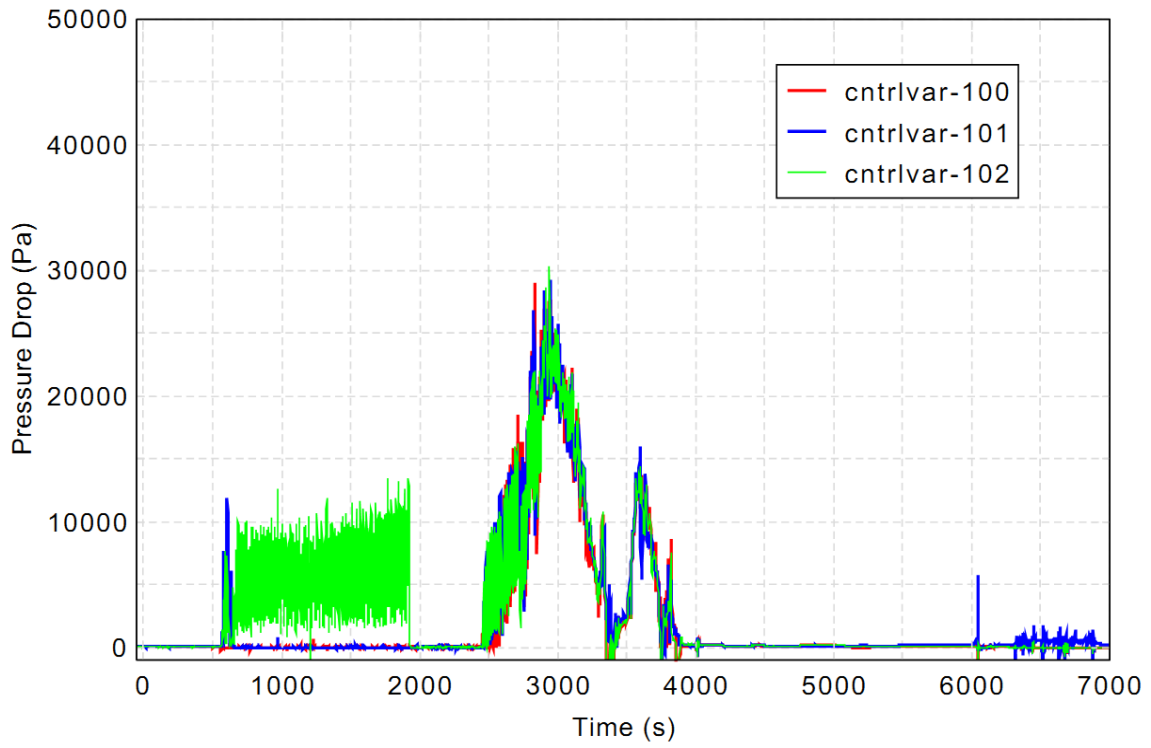

Figure 19. Test phase: Pressure drop across U-tubes

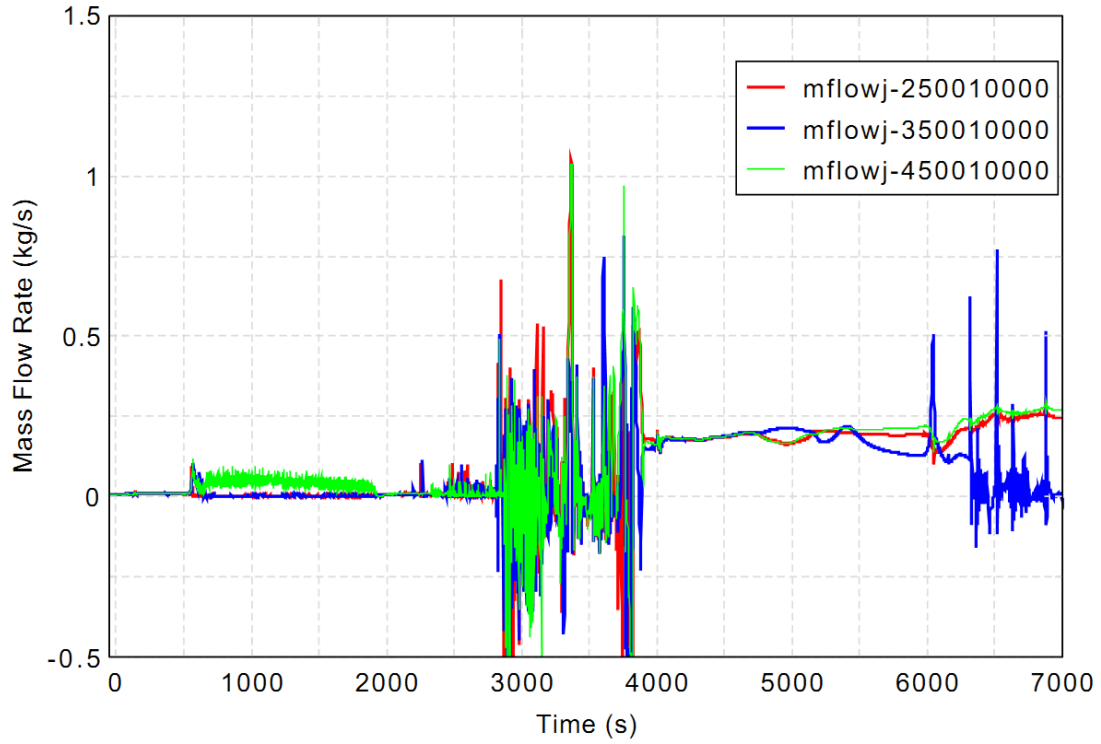

Figure 20. Test phase: Mass flowrate in the loops at the SG outlet

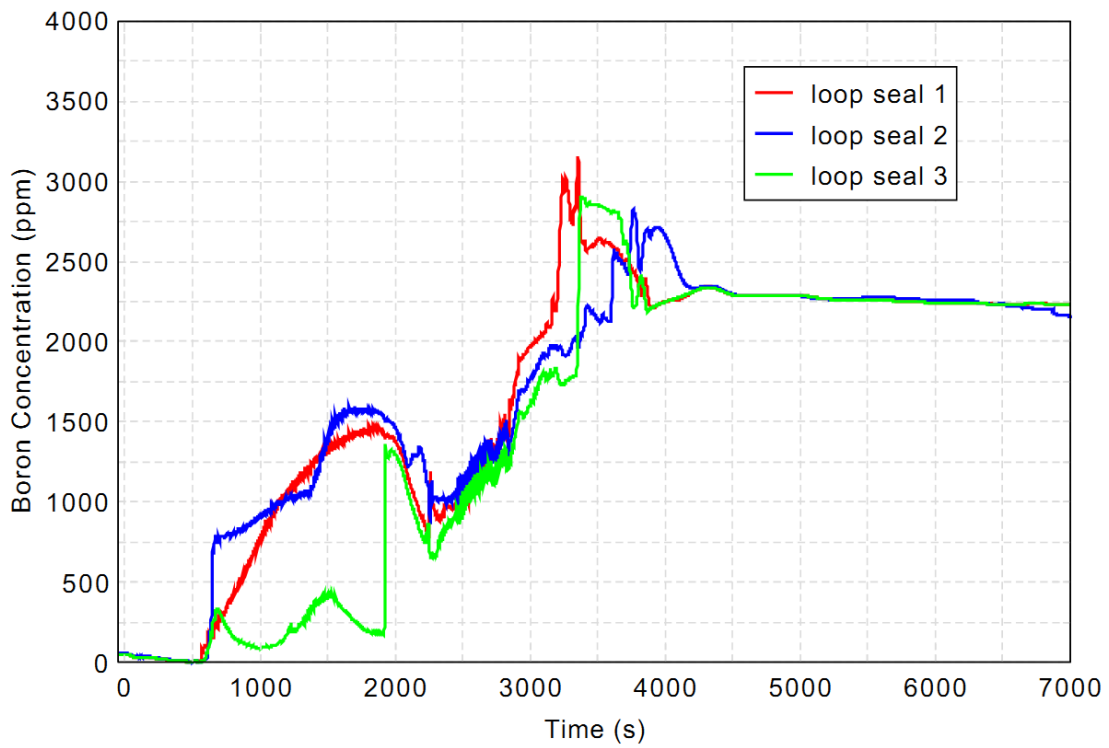

Figure 21. Test phase: Boron concentration at loop seal bottom

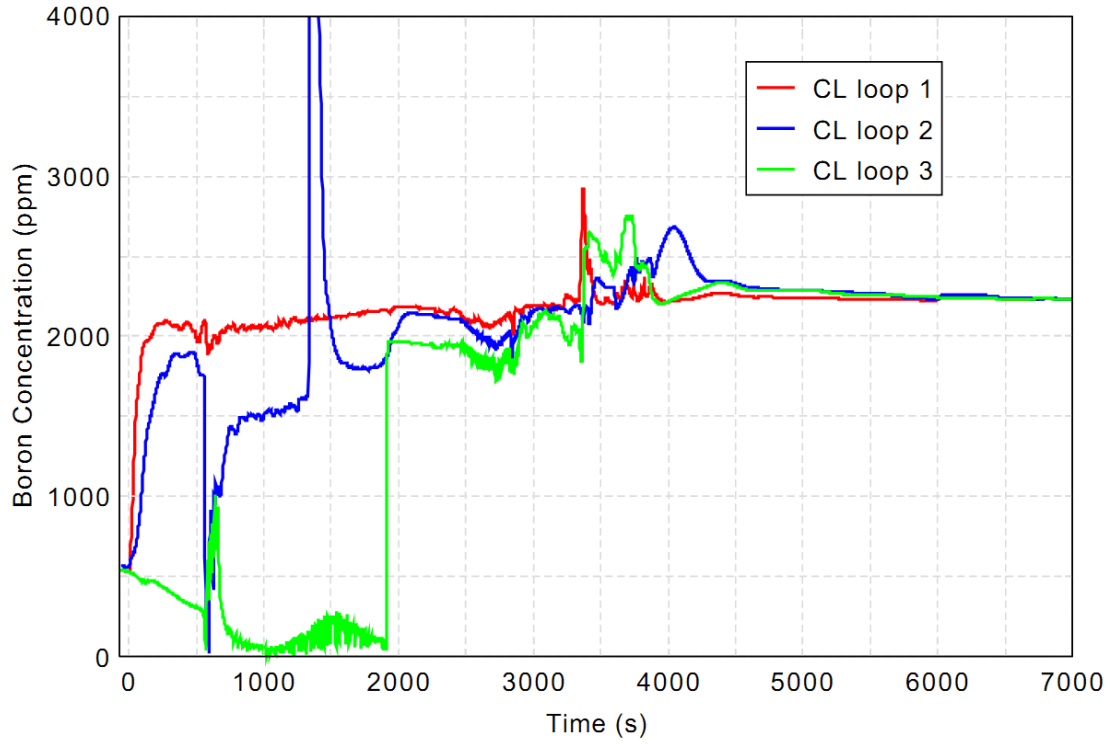

Figure 22. Test phase: Boron concentration in cold legs

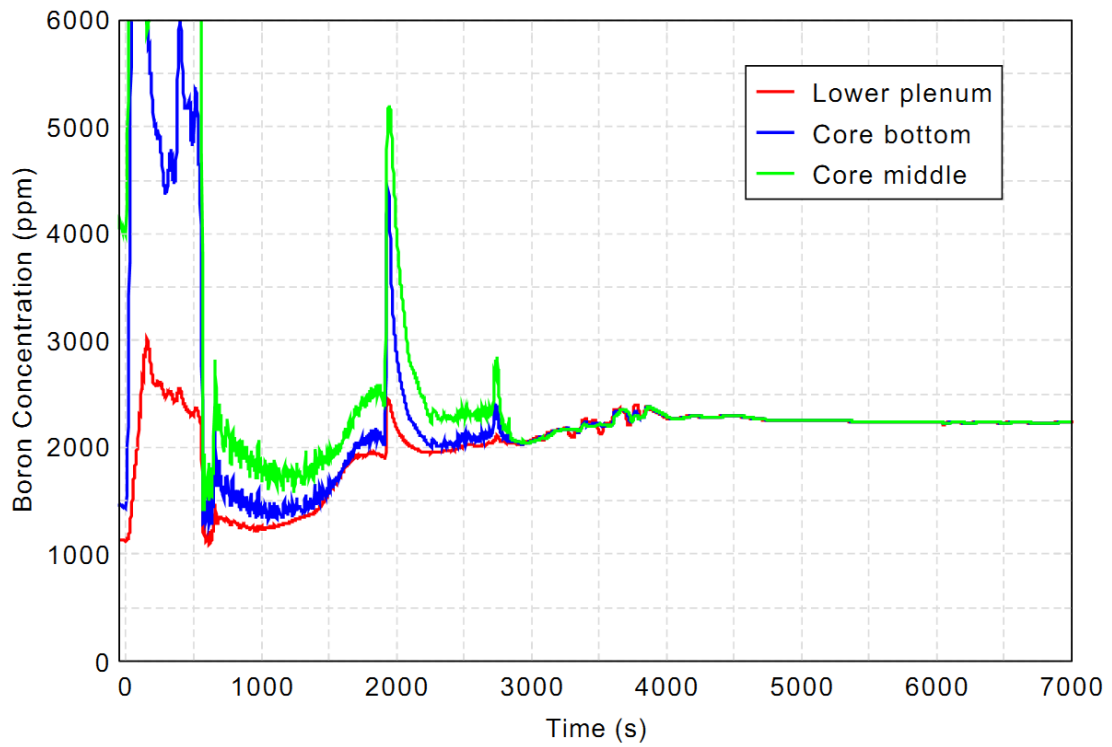

Figure 23. Test phase: Boron concentration inside power channel

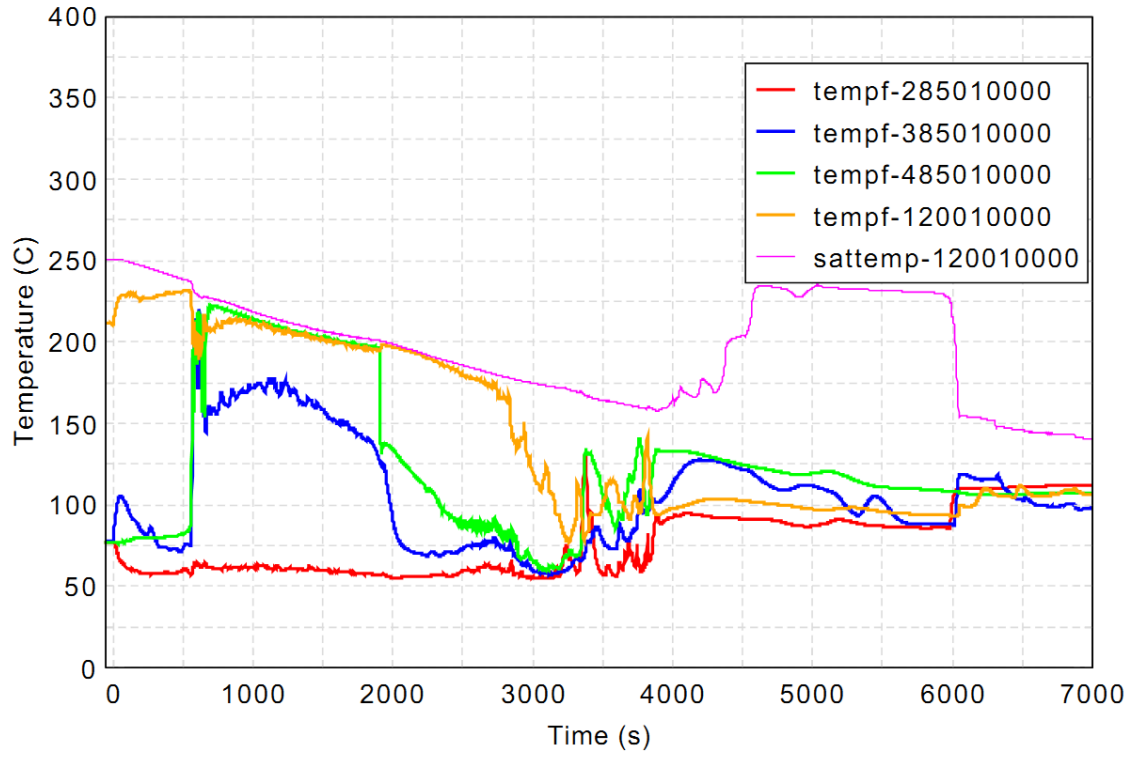

Figure 24. Test phase: Fluid temperatures in cold legs and lower plenum

7. Requirements to facility measurement system

Apart from the typical measurement system of an ITF which is already available at SPES facility, certain specific requirements are posed for the current experimental test:

- boron concentration measurements;
- mass flow and flow direction measurements;
- pressure drop measurements.

The instrumentation for the boron measurements is required of two different types:

1. the COMBO (Continuous Measurement of Boron Concentration) devices or similar;
2. sampling points.

The COMBO (Continuous Measurement of Boron Concentration) devices are suitable for the continuously measuring of the boron concentration and they are operating according to the principle of neutron absorption. The COMBO system was originally developed by Siemens (now Framatome-ANP) for use in real PWR. The measuring principle is based on the absorption of neutrons by the isotope B-10, which varies according to the boron content of the coolant. The COMBO system, which basically consists of a neutron source (positioned on one side of the reactor coolant line - RCL) and two counter tubes (installed close together on the opposite side of the RCL) can be mounted on the outer wall of the RCL so that it has no effect on the fluid being measured. A scheme of the COMBO device arrangement is reported in Figure 25. The result of using this neutron transmission method is a measurement averaging over the entire flow cross section in the pipe.

The test facility has to be also retrofitted with sampling points for taking grab samples at several locations in the primary system, such as in the loop seals, in the steam generator inlet and outlet plena, in the downcomer and in the region of the core.

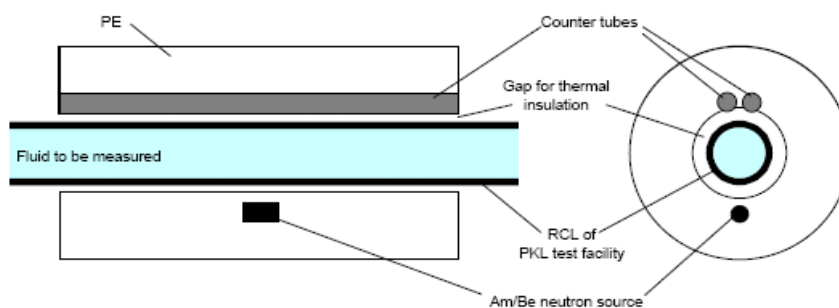

Figure 25. COMBO device arrangement scheme

The proposed locations for the installation of boron measurement devices are the following:

- COMBO devices
 - Cold legs at the inlet to the downcomer (trends of Figure 22 substantiate the present proposal)
- Sampling
 - Hot legs
 - Loop seal descending leg
 - Loop seal bottom
 - Loop seal ascending leg
 - Downcomer top
 - Downcomer bottom
 - Core bottom
 - Core top

Due to high cost of the COMBO devices, it has been investigated the possibility to perform the measurement of boron concentration by electrical conductivity probes to be installed at the SPES facility. The electrical conductivity measurements performed with those probes are intended to detect the arrival of the injected boric acid solution at specified key locations and thus indirectly provide a precise quantification of the overall boron affecting the selected transient, which can be exactly defined only experimentally. Conductivity probes can be used in the SPES facility to measure the conductivity of the water (which is altered by the presence of boric acid) and then to obtain the boric acid concentration as a function of time during the experiment. In this way they allow to detect the passage of the solution and to measure the injection time sequence, defined as the span time between the starting of the typical considered event and the entrance of the first infinitesimal volume of boron into the moderator tank.

The proposed conductivity sensors are custom-made needle probes designed and manufactured according to the following technical specification:

- Measurements of local electrical conductivity in water (maximum conductivity 40 $\mu\text{S}/\text{cm}$) for operation with 10 kHz fast conductivity signal sampling electronics;
- Coaxial electrode design;
- Temperature range: 5 °C to 80 °C;
- Maximum static differential pressure between probe head and probe body: 12 MPa;
- Probe shaft diameter: 10 mm.

The selected probe is supported by a steel tube mounted onto a tank replacing the moderator by a Swagelok-type fitting, which in turn will be screwed on the tank, Figure 26. Owing to the adoption of Swagelok connections, each probe can be inserted into the tank to the needed extent. The

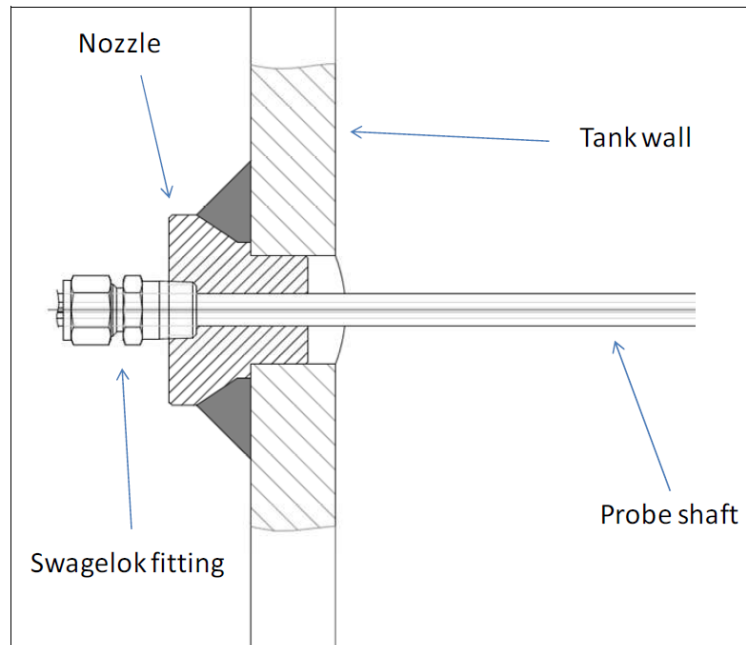

Figure 27. Mechanical interface between the probe and the coolant

8. Conclusions

The feasibility study of a boron dilution distribution test in condition of reduced mass inventory (e.g. SB-LOCA event) in the SPES experimental facility has been performed. The conditions of the analysed test have been selected to constitute the counterpart to test E2.2 performed at PKL facility.

The test initiates with a partially drained reactor coolant system with symmetrical energy removal in the reflux-condenser mode via all SG at a primary-side pressure of 40 bar and boron concentration in the loop seals less than 50 ppm. In order to predict the SPES performance during the proposed test, the system thermal-hydraulic computer code RELAP5/Mod3.3 has been used and a nodalization for the SPES facility has been updated, starting from an input previously developed, qualified and applied by University of Pisa for simulation and analysis of the experimental test SP-SB-04. Two phases of boron dilution distribution test have been simulated:

- Conditioning phase, required to achieve the conditions of the facility corresponding to the “start-of-test” state;
- Test phase, actually simulating the facility refill and boron re-distribution in the facility under conditions of asymmetric ECC injection.

It has been demonstrated that it is feasible to achieve SOT conditions in SPES in about 3300 s, starting from full-pressure low-power low-flow conditions in the primary side, by opening the break in the CL loop 2, closing it when the primary mass inventory decreases to 50% and operating in reflux-condenser mode conditions until the boron concentration in loop seals reaches 50 ppm.

In order to constitute a counterpart to test E2.2 in PKL facility, the boundary conditions for the test phase in SPES facility have been derived from PKL experimental measured data following the power-to-volume scaling approach: the PKL secondary side pressure has been imposed at the outlet from SG in SPES nodalization; break area, power, HPSI and LPSI mass flow rates have been scaled down using the ratio of primary side volume of two facilities.

The calculation results demonstrated that the main thermal-hydraulic aspects, which have been observed in the test E2.2 at PKL facility, are present in the test phase in SPES facility: reflux-condenser mode, facility refill by ECC system intervention, natural circulation in all loops during asymmetric ECC injection and change of boron distribution in the facility. Thus, it may be concluded that boron dilution distribution test is feasible in SPES facility, with the boundary conditions specified.

In addition, some requirements for the SPES measurement system have been identified: the facility must be equipped with boron concentration and mass flow rate measurement devices in order to conduct the experimental test and provide meaningful information for the subsequent analysis.

References

- [1] D'Auria F., Galassi G.M., *"Code assessment methodology and results"*, IAEA Technical Workshop/Committee on Computer Aided Safety Analyses, Moscow, May 14-17, 1990
- [2] H. Kremin, et al.; *"Determination of Individual Volumes and of Total Volume in the PKL Test Facility"*; FANP NT31/01/e33, Technical Centre of FRAMATOME-ANP Erlangen, Germany, August 2001
- [3] F. D'Auria, et al.; *"Evaluation of the Data Base from High Power and Low Power Small Break LOCA Counterpart Tests Performed in LOBI, SPES, BETHSY and LSTF Facilities"*; Università di Pisa, DCMN NT 237 (94), Pisa, November 1994
- [4] H. Kremin, et al.; *"Determination of Thermal Losses in the PKL Test Facility"*; FANP NT31/01/e36, Technical Centre of FRAMATOME-ANP Erlangen, Germany, September 2001
- [5] OECD/SETH: PKL III E2.2, CD-ROM, FRAMATOME-ANP GmbH TGT1, 11 November 2002
- [6] Bolognini C, Gandolfi S., Medich C, Rigamonti M., Vescovi O., Visconti G., Boiardi A., *"Experimental data report - SPES test SP-SB-04"*, SIET, Sviluppo e Qualifica di Componenti Termomeccanici, Piacenza (ITALY), March 1992.
- [7] *"RELAP5/Mod3.3 Code Manual Volume I: Code structure, system models, and solution methods"*, NUREG/CR-5535/Rev P3-Vol I, Information Systems Laboratories, Inc., Idaho Falls, March 2003
- [8] F. D'Auria, M. Frogheri, W. Gianotti *"RELAP5/MOD3.2 Post Test Analysis and Accuracy Quantification of SPES Test SP-SB-03(04)"*, NUREG/IA-0154(55), February 1999
- [9] D'Auria F., Galassi G.M. *"Scaling in nuclear reactor system thermal-hydraulics"* Nuclear Engineering and Design Volume 240, Issue 10, October 2010, Pages 3267-3293