



Agenzia nazionale per le nuove tecnologie, l'energia  
e lo sviluppo economico sostenibile



*Ministero dello Sviluppo Economico*

RICERCA DI SISTEMA ELETTRICO

15x15 Ti Production and Procurement

*S. De Vrieze, N. De Wispelaere*

Report RdS/2012/045

15X15 Ti PRODUCTION AND PROCUREMENT

S. De Vrieze, N. De Wispelaere – OCAS NV

Settembre 2012

Report Ricerca di Sistema Elettrico

Accordo di Programma Ministero dello Sviluppo Economico - ENEA

Area: Governo, gestione e sviluppo del sistema elettrico nazionale

Progetto: Nuovo nucleare da fissione: collaborazioni internazionali e sviluppo competenze in materia nucleare

Responsabile del Progetto: Mariano Tarantino, ENEA

**Titolo**

**15x15 Ti production and Procurement**

**Ente emittente** OCAS NV

## PAGINA DI GUARDIA

**Descrittori**

**Tipologia del documento:** Rapporto Tecnico  
**Collocazione contrattuale:** Accordo di programma ENEA-MSE: tema di ricerca “Nuovo nucleare da fissione”  
**Argomenti trattati:** Tecnologie dei Materiali  
 Metallurgia  
 Generation IV Reactors

**Sommario**

At the request of ENEA, OCAS will produce in the Metal Processing Center (group of equipment needed to lab simulate the steel making process) approx. 1 ton of 15x15 Ti stainless steel.

The aim of the supply is

- the production and reporting concerning the manufacturing process for the production of 15-15 Ti stainless steel plates, 20% CW
- the delivery of 17 lab casts and the production of 15-15 Ti SS 20% CW plates, 15mm X 750mm X 250mm (about 1 ton)
- the shipment of the plates to the C.R. ENEA Brasimone, Italy

In this document, the production route is described and the results of the characterization tests on the lab material are summarized.

**Note**

PAR2011 LP3-B1.C.

**Autori**

Sylvia De Vrieze, Nico De Wispelaere (OCAS NV)

**Copia n.**

**In carico a:**

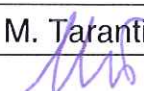
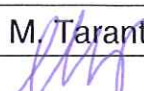
2			NOME			
			FIRMA			
1			NOME			
			FIRMA			
0	EMISSIONE	18/09/2011	NOME	M. Tarantino	NA	M. Tarantino
			FIRMA			
REV.	DESCRIZIONE	DATA		CONVALIDA	VISTO	APPROVAZIONE



## Report: 15x15 Ti production for ENEA

Author(s): **Sylvia De Vrieze, Nico De Wispelaere**  
Publication date: **August, 2012**  
Our reference: **68320**  
Customer: **ENEA**

OCAS NV  
Pres. J.F. Kennedylaan 3, BE-9060 Zelzate  
Tel 32 (0)9 345 12 11  
Fax 32 (0)9 345 12 04  
[services@ocas.be](mailto:services@ocas.be)  
<http://www.ocas.be>



## 1 Introduction and Conclusion

At the request of ENEA, OCAS will produce in the Metal Processing Center (group of equipment needed to lab simulate the steel making process) approx. 1 ton of 15x15 Ti stainless steel.

The aim of the supply is

- the production and reporting concerning the manufacturing process for the production of 15-15 Ti stainless steel plates, 20% CW
- the delivery of 17 lab casts and the production of 15-15 Ti SS 20% CW plates, 15mm X 750mm X 250mm (about 1 ton)
- the shipment of the plates to the C.R. ENEA Brasimone, Italy

In this document, the production route is described and the results of the characterization tests on the lab material are summarized.

## 2 Technical specifications 15x15 Ti steel

### 2.1 Composition (w%)

$0,08 \leq C \leq 0,10$	
$14,0 \leq Cr \leq 16,0$	Optimal 14,5
$14,0 \leq Ni \leq 16,0$	Optimal 15,5
$1,0 \leq Mn \leq 2,0$	
$1,3 \leq Mo \leq 1,7$	
$0,30 \leq Ti \leq 0,5$	Optimal $(Ti/4 C) \geq 1,0$
$Nb + Ta \leq 0,3$	
$0,70 \leq Si \leq 0,9$	Optimal 0,85
$0,003 \leq B \leq 0,008$	Optimal $\geq 0,004$
$0,03 \leq P \leq 0,05$	Optimal 0,045
$N \leq 0,015$	
$S \leq 0,015$	
$Al \leq 0,015$	
$Zr \leq 0,03$	
$W \leq 0,03$	
$V \leq 0,03$	
$Cu \leq 0,03$	
$Co \leq 0,03$	
$Ca \leq 0,03$	

### 2.2 Production summary

After vacuum casting, the steel is subjected to a homogenization annealing treatment in order to decrease the inter-dendritic micro-segregation as well as to minimize the amount of delta ferrite in the microstructure (in order to obtain a circa 100% austenitic microstructure).

The steel blocks will be wrapped in stainless steel foil and welded in a metal box to avoid excessive oxidation (see picture). Air cooling to room temperature post heat treatment is applied.



**Picture 1.** Illustration of block of steel welded metal box to avoid excessive oxidation during heat treatment

The lab cast ingots will be cut in blocks and hot rolled down to a thickness of approx. 20mm. After hot rolling, the steel sheets are annealed followed by water quenching.

Grain size will be determined after this annealing & quenching treatment in the middle of 1 sheet per lab cast. Grain dimensions must be in the range  $5 < G < 9$  according to the NF/A 104-02 AFNOR rules.

After removing the surface oxide, which is formed after hot rolling and during annealing, the sheets are cold worked (25%) down to 15mm.

The mechanical properties are expected to be in compliance with (but will not be tested at OCAS):

- $620 \text{ MPa} \leq R_{p0,002} \leq 840 \text{ MPa}$  according to NF/A/ 49-851 AFNOR rules
- $A_{tot} \geq 18\%$  according to NF/A/ 49-851 AFNOR rules
- $R_m \geq 760 \text{ MPa}$  according to NF/A/ 49-851 AFNOR rules

### 3 MPC lab production

In this chapter, the general production steps will be explained in detail. In the next chapter, the specific production parameters, as well as the obtained composition and grain size after hot rolling and annealing for each of the 17 lab casts will be summarized.

#### 3.1 Casting

The lab heats are realised in a vacuum induction furnace (**Picture 2**).



**Picture 2.** Vacuum Induction furnace

Each lab cast has a total weight of approx. 100kg and the following alloying materials were used:

- Fe: Aluminium killed steel (low impurity content)
- C: Graphite
- Mn: Electrolytic refined Mn (pure)
- Si: Ferro-silicon
- P: Ferro-phosphor
- Ti: Ferro-titanium
- Cr: Electrolytic refined Cr (pure)
- Ni: Nickel briquettes (pure)
- B: Ferro-boron
- Mo: Ferro-molybdenum

The bulk of the alloying materials are loaded in the crucible (as illustrated in **Picture 3**), after which the vacuum furnace is closed. The air is extracted from the furnace by means of a vacuum pump, after which the chamber is filled with Argon (1 atm). The cast-iron ingot, coated with a protective layer (see **Picture 4**) is also present within the vacuum chamber of the furnace,

Through induction, the raw materials are heated up to approx. 1600°C to obtain a liquid steel bath (see **Picture 5 and 6**). Small additions of alloying elements can be introduced in the vacuum furnace without introducing air through a system of valves.

When all alloying elements have been introduced in the liquid steel bath, the liquid steel is allowed to homogenise during 20-30 minutes (the liquid steel is stirred by the magnetic field). Before casting the steel, the temperature of the liquid steel is lowered to approx. 25°C above the solidification temperatures. When the correct temperature is realised, the steel is cast in the ingot (see **Picture 7**). As the superheat (difference between the liquid steel temperature and the solidification temperature) is low, a rapid solidification is obtained which minimises segregation in the steel.

After cooling down, the vacuum furnace is opened and the solid steel block is lifted out of the ingot (see **Picture 8**).





**Picture 3.** *Raw materials are placed in the crucible of the vacuum furnace*



**Picture 4.** *Crucible with protective coating*

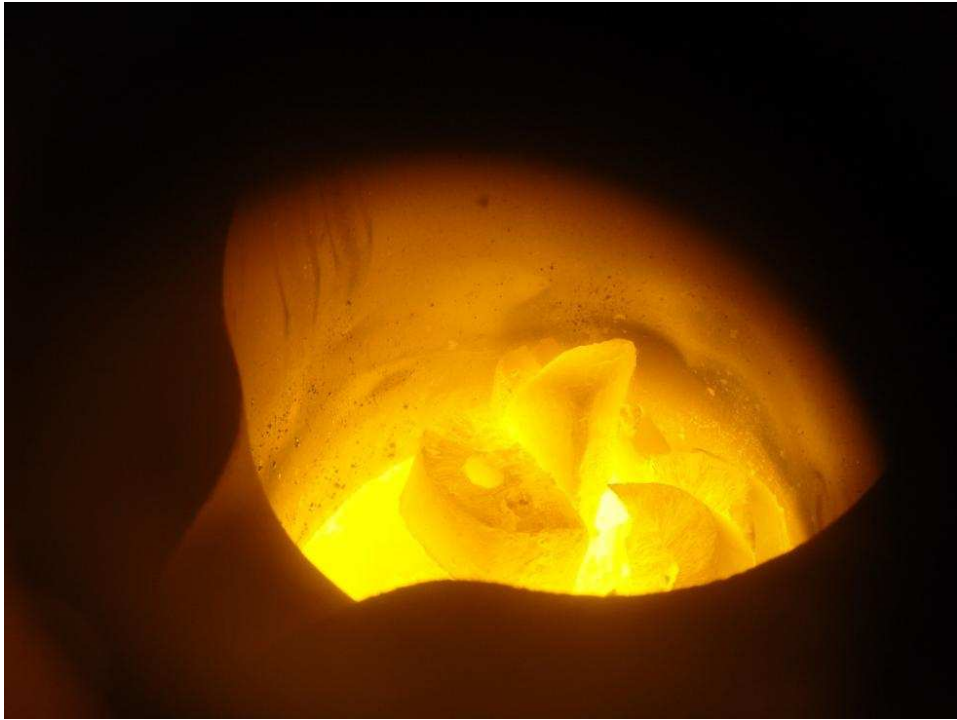

**Picture 5.** *Raw materials heating up by induction (partially melted)*

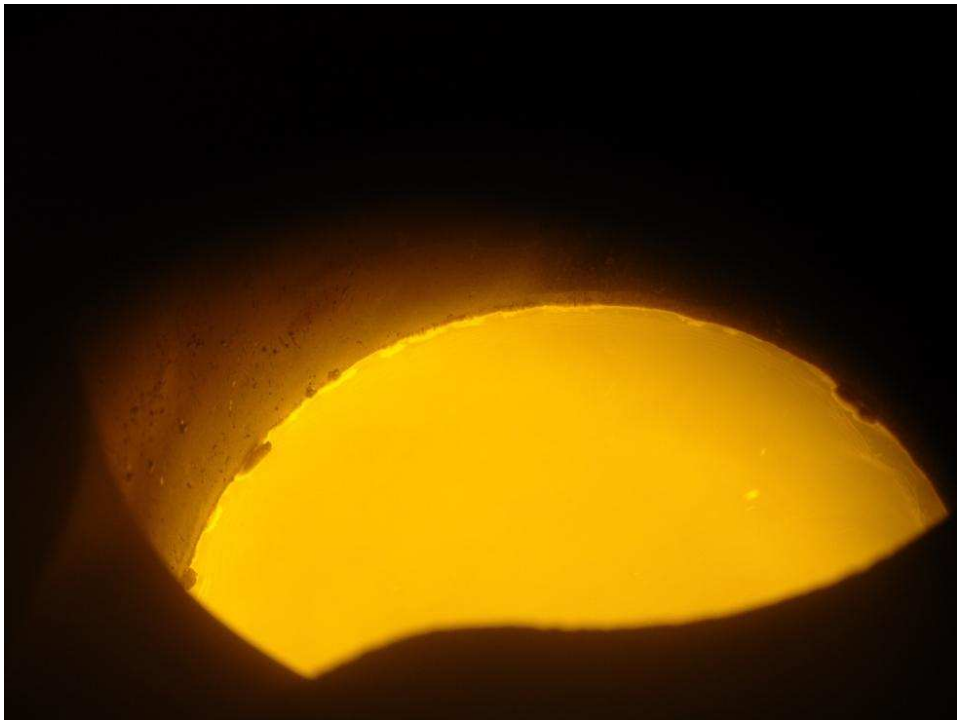

**Picture 6.** *Raw materials heating up by induction (almost fully melted)*

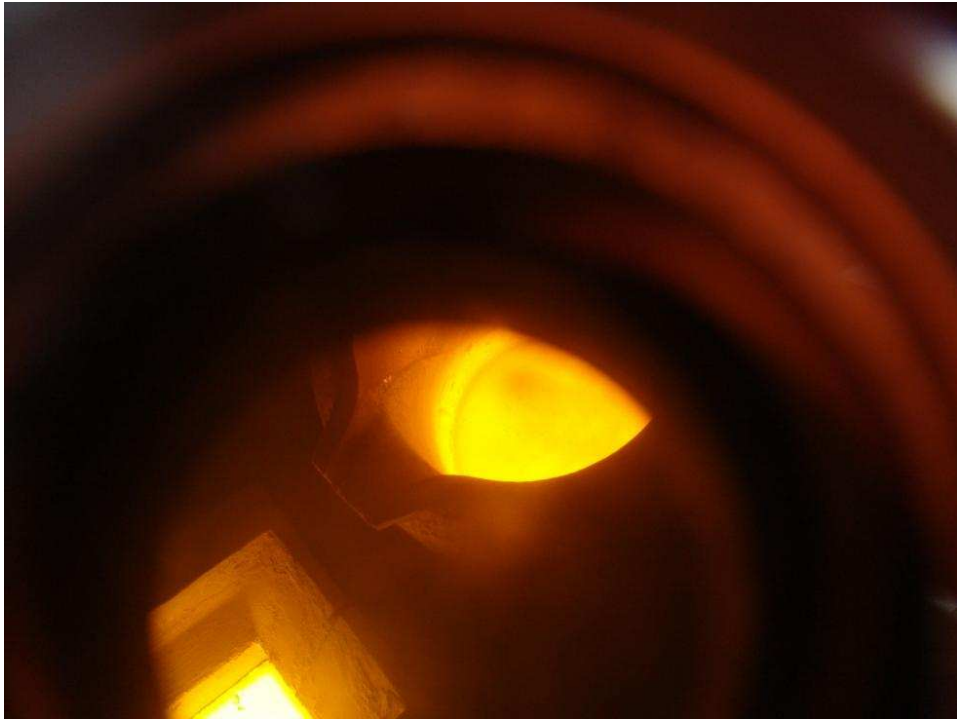

**Picture 7.** *The liquid steel is cast in the ingot*

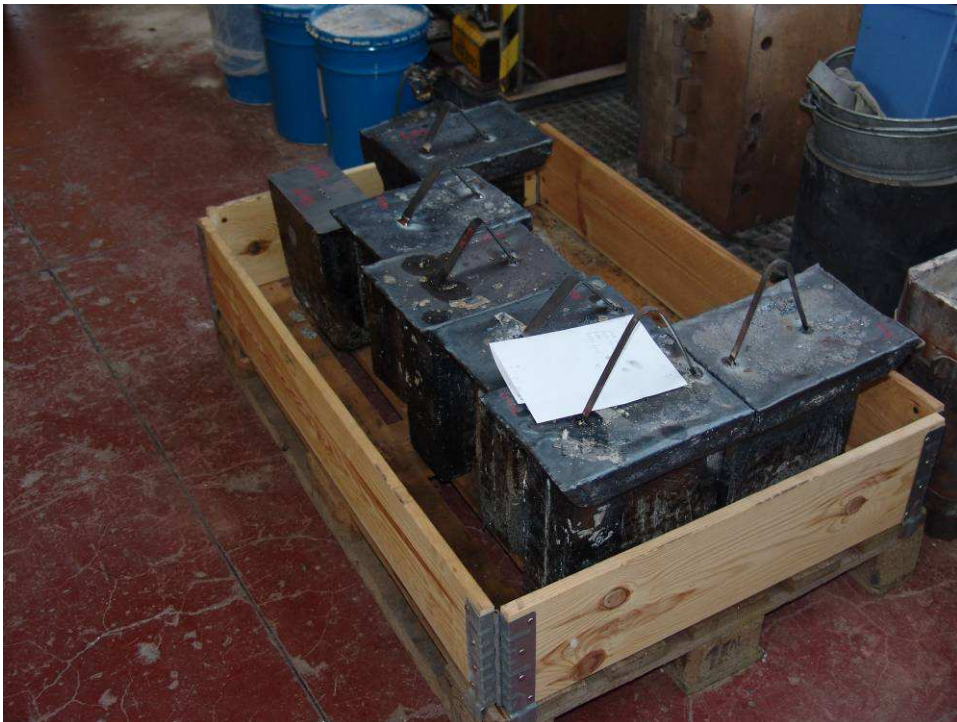

**Picture 8.** *15x15 Ti 100kg ingots*

The ingots are cut in 4 pieces: one for composition analysis and 3 for further hot rolling (see **Picture 9 and 10**). The blocks for hot rolling are identified with a letter code which is added to the cast number. Thus, the three blocks for hot rolling which are cut from cast G106 are identified as G106A, G106B and G106C. The block A is extracted from the bottom of the ingot, block B from the middle and block C from the top (just below the position where the slice is cut for composition analysis).

The head of the ingot is scrapped as it contains solidification porosities as well as oxides (if they were present in the liquid steel).

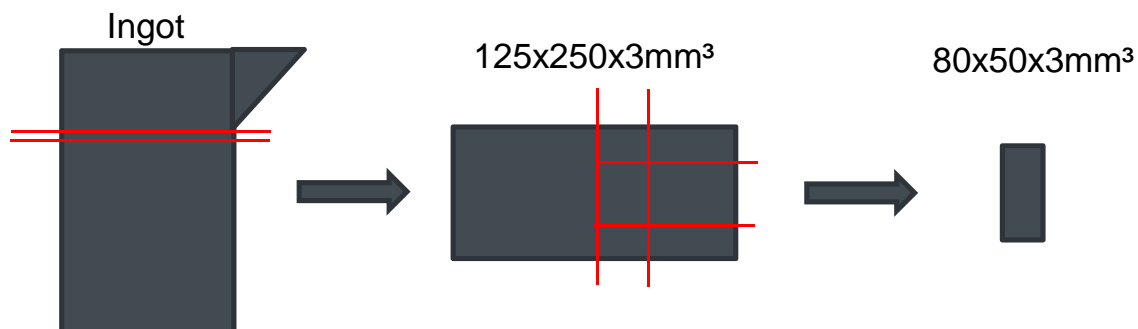

**Picture 9.** Illustration sampling position for composition analysis



**Picture 10.** Illustration of the cut blocks out of an ingot

The composition of the 17 casts has been determined by means of SS-OES and XRF (C, S, N and O have been determined via combustion analysis (melt extraction)). The results (only the alloying elements, not the impurity levels) are grouped in **Table 1**. In chapter 4 the results for all elements per cast are given (composition, processing details, grain size).

**Table 1.** Realised compositions (alloying elements only, w%, SS-OES and combustion analysis for C)

<b>Cast Code</b>	<b>C</b>	<b>Mn</b>	<b>Si</b>	<b>P</b>	<b>Ti</b>	<b>Cr</b>	<b>Ni</b>	<b>B</b>	<b>Mo</b>
G106	0.097	1.45	0.79	0.040	0.38	15.03	15.03	0.0061	1.50
G107	0.097	1.63	0.88	0.040	0.44	14.47	15.25	0.0066	1.50
G108	0.094	1.60	0.87	0.040	0.41	14.57	15.39	0.0063	1.53
G109	0.098	1.66	0.83	0.041	0.41	14.59	15.34	0.0063	1.55
G110	0.098	1.46	0.79	0.046	0.39	14.37	15.89	0.0068	1.46
G111	0.091	1.49	0.84	0.038	0.40	14.07	15.71	0.0074	1.49
G112	0.092	1.47	0.78	0.042	0.39	14.29	15.85	0.0060	1.43
G113	0.087	1.45	0.74	0.042	0.36	14.17	15.55	0.0063	1.54
G114	0.086	1.51	0.78	0.044	0.42	14.15	15.35	0.0070	1.50
G115	0.092	1.49	0.77	0.043	0.42	14.48	15.43	0.0072	1.53
G116	0.093	1.51	0.76	0.042	0.42	14.35	15.64	0.0067	1.54
G117	0.083	1.44	0.73	0.042	0.36	14.28	15.83	0.0066	1.51
G118	0.085	1.46	0.73	0.041	0.40	14.35	15.89	0.0066	1.52
G119	0.086	1.46	0.74	0.044	0.39	14.44	15.76	0.0066	1.50
G120	0.086	1.47	0.74	0.044	0.41	14.41	15.83	0.0064	1.50
G121	0.081	1.49	0.75	0.040	0.41	14.54	15.89	0.0065	1.46
G122	0.078	1.49	0.77	0.040	0.41	14.51	15.88	0.0066	1.51

### 3.2 Homogenization annealing treatment

Most austenitic stainless steels contain a limited amount of delta ferrite in the solidified structure, which is linked to the solidification path and subsequent transformations. The delta ferrite is meta-stable, but it can only transform into austenite at high temperature.

In order to remove (or minimize) the amount of delta ferrite in the final product, as well as to homogenize the composition (decreasing the interdendritic micro-segregation), the blocks are subjected to an extensive annealing treatment.

In order to avoid oxidation during this annealing treatment, the blocks are wrapped in three layers of stainless steel foil (316L, 100micron) and subsequently welded into boxes of 3mm thick carbon steel.

#### Annealing treatment:

- 15h (time in furnace) in a furnace at 1230°C (no thermocouple logging possible).

The wrapped and welded-in blocks are taken out of the furnace, air-cooled to room temperature. The carbon steel boxes are opened with a rotating disc, after which the 15x15 Ti steel blocks are taken out. Then, they are re-wrapped in stainless steel foil to avoid oxidation during the reheating prior to hot rolling.

### 3.3 Hot rolling

Prior to hot rolling, the blocks are reheated in a furnace up to 1250°C. The blocks are reheated during 1.5-2h. One by one, the blocks are taken out of the furnace and hot rolled down to the final thickness.

The blocks are hot rolled down to 20mm in 13 passes. The final hot rolling temperature is above 1000°C. Detailed information of the hot rolling (rolling forces, inter-pass times, torque ...) is available upon request. After hot rolling, the sheets are air cooled to ambient temperature.

The first 3 casts (G106-107-108) were hot rolled with a width of 250mm (initial length 125mm), which resulted in high rolling forces. After discussion with ENEA, it was agreed to turn the blocks 90° to reduce the width. Thus, the width of all subsequent casts (G109 and onward) is 125mm (initial length 250mm).

### 3.4 Annealing treatment

After hot rolling, the sheets are heat treated.

All the sheets of 1 cast are placed in a furnace at 1080°C (next to each other, not on top of each other). A thermo-couple is attached to sheet A. When the sheet temperature has been above 1065°C for 45-50 minutes, the sheets are taken out of the furnace and water-quenched.

The raw data, as well as the processed data, of each annealing cycle (one cycle per lab cast) is available in the file "Post hot rolling annealing.xls", which can be found in attachment to this report. The annealing cycles are summarized in **Table 2**. The time-temperature curves of the sheets of lab cast G106 are shown (as example) in **Pictures 11** and **12**.

**Table 2.** Overview of annealing cycles (post-hot rolling)

<b>Cast Code</b>	<b>Time in furnace (min)</b>	<b>Time above 1065°C (min)</b>
G106	72	49
G107	70	48
G108	72	52
G109	68	46
G110	68	47
G111	68	46
G112		
G113		
G114		
G115		
G116		
G117		
G118		
G119		
G120		
G121		
G122		

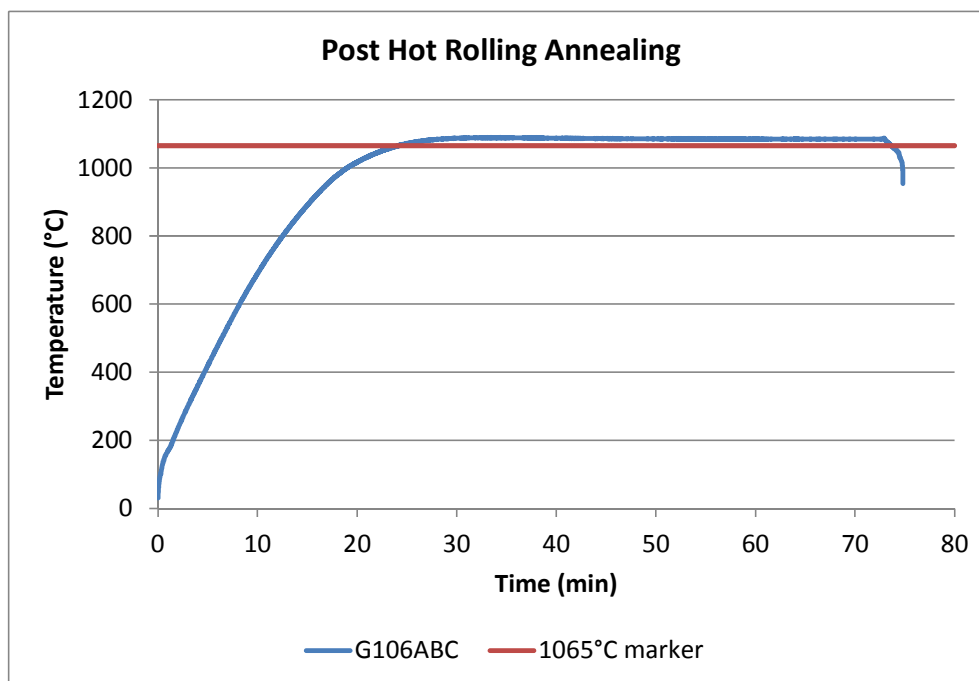

**Picture 11.** Thermal cycle of the annealing treatment of the hot rolled sheets from cast G106

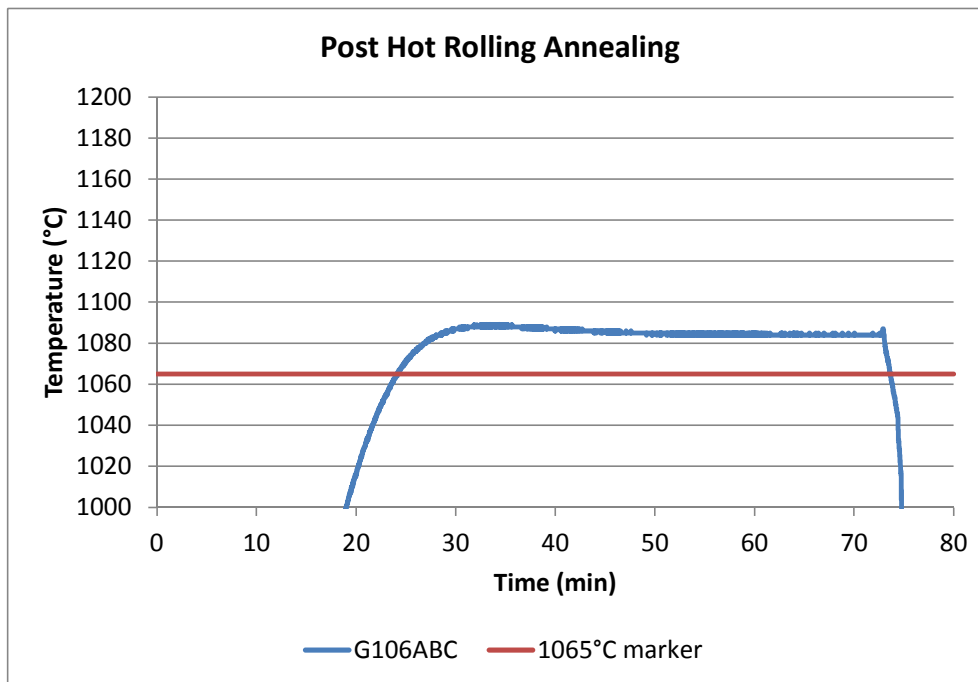

**Picture 12.** Thermal cycle of the annealing treatment of the hot rolled sheets from cast G106, illustration of the holding time above 1065°C

The sheets of casts G106, G107 and G108 were annealed and quenched in the hot rolled form. Afterwards, they were cut in two identical pieces.

The sheets of all other casts (which were hot rolled into longer, smaller strips) were cut in two prior to annealing (as they were too big to fit in the furnace otherwise). This is illustrated in **Picture 13**. The sampling position for grain size control is also visualized in this picture (small brown square).





### 3.5 Cold working

After the annealing and water-quench treatment, the sheets are sand-blasted to remove all external oxides. In the final production step, the sheets are given a thickness reduction by means of cold rolling of 25% (from 20mm to 15mm).

The final product is visualized in **Pictures 14** and **15**.



Picture 14. G106B, finished product



Picture 15. G109C, finished product

### 3.6 Sheet dimensions

The dimensions of the blocks and sheets in the different production steps are grouped in the file "Sheet dimensions.xls" (in attachment to this document).

### 3.7 Metallography

After hot rolling and annealing & quenching, the grain size is determined in one sheet of each cast (sheet A). The microstructure is shown in chapter 4. The average grain size is summarized in **Table 3**.

**Table 3.** Grain size after annealing & quenching

Cast Code	ASTM	2D-diameter ( $\mu\text{m}$ )
G106	8.96	16.1
G107	8.01	22.4
G108	8.36	19.8
G109	8.24	20.7
G110	8.88	16.6
G111	8.48	19
G112		
G113		
G114		
G115		
G116		
G117		
G118		
G119		
G120		
G121		
G122		

The samples were electrolytic etched with Nitric acid to visualize the microstructure. The grain size measurements were performed conform to the ASTM E112-96 (04). The absolute uncertainty on the individual ASTM-values, measured with the lineal intercept method has been estimated to be 0.1 G unit. This is only valid on equi-axed grains. The "real" mean grain size is always larger than the size measured according the ASTM-norm. This is important for modeling of physical metallurgical

phenomena for which the grain size is a specific factor. (see § 4.3 and 4.4 in "The Physical Metallurgy of Micro-alloyed Steels" van T. Gladman).

The stainless steel is difficult to polish and to etch mainly near the edge of the sheet, which is illustrated by **Picture 16**. In this macroscopic overview picture, it can be seen that flow lines are visible after etching. Most likely the material is superficially smeared open during polishing, making it difficult to etch correctly. A zone in the middle of this sample is shown in **Picture 17** at higher magnification, where the un-etched zones are clearly visible.

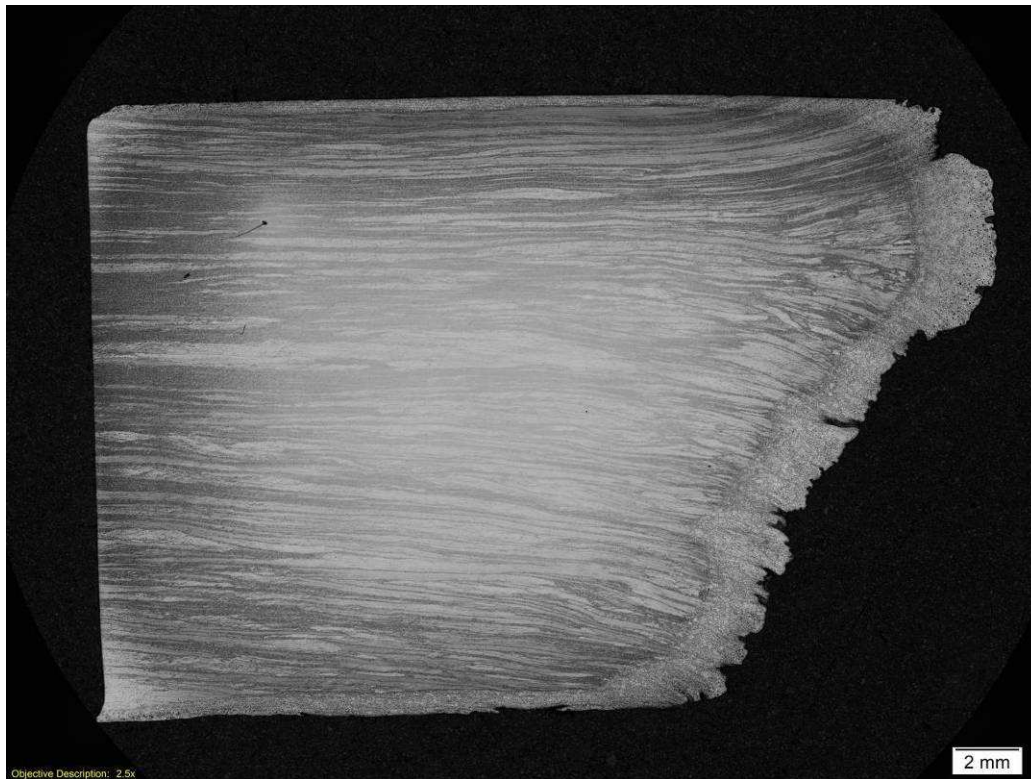

**Picture 16.** Illustration of polishing lines after electrolytic etching (very severe case, edge of G109A)

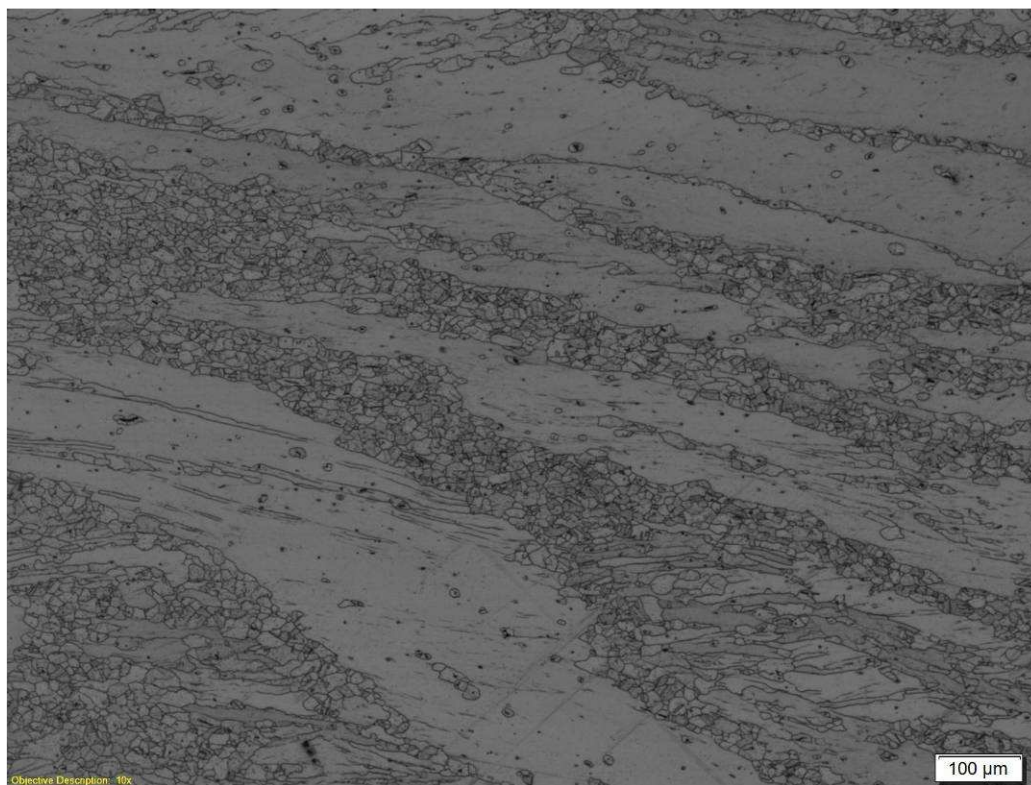

**Picture 17.** Detail image of the center of Picture 16 at higher magnification

In order to evaluate whether or not the large un-etched zones could be large grains, EBSD measurements were performed on a polished sample of G109A. The EBSD grain mapping is shown in **Picture 18**. In the un-etched zones, a similar grain size can faintly be seen as in the etched area's, which indicates that a superficial layer is present on top of the bulk structures (due to mechanical polishing). As the penetration depth of EBSD measurements is only a few micron, it can be concluded that the layer is indeed superficial.

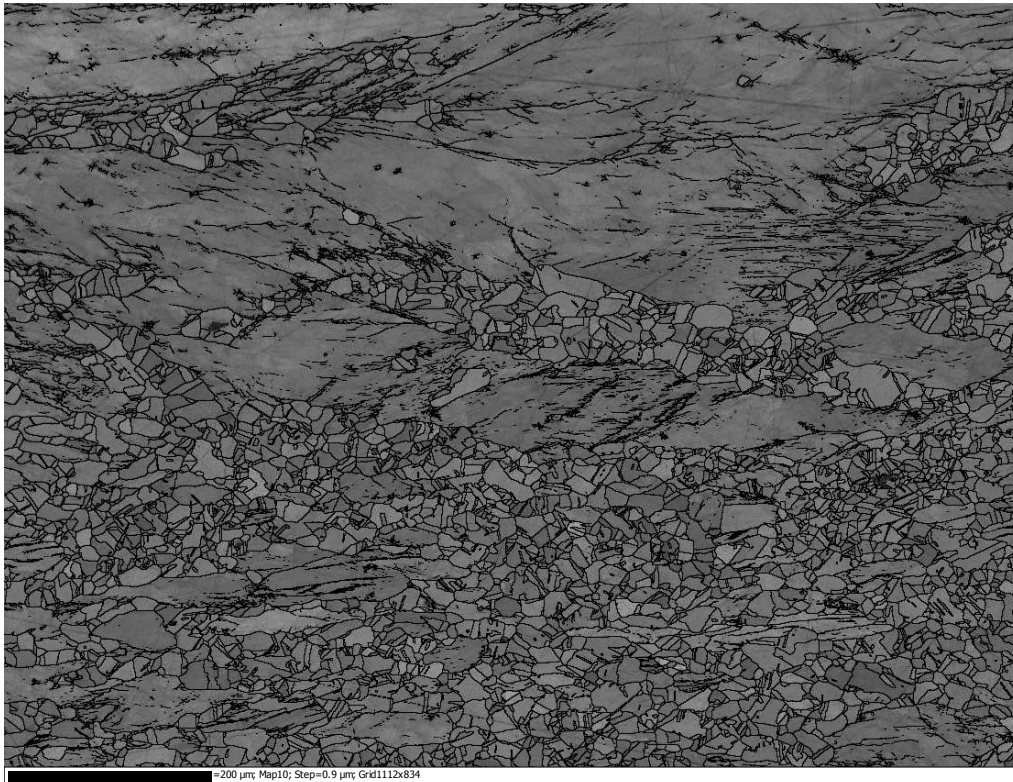

**Picture 18.** EBSD image of mechanically polished G109A

In order to avoid the “smearing effect”, several sample preparation options are possible:

- Electrolytic polishing to remove the top layer after mechanical polishing (technique unavailable at OCAS at present),
- Cross-section polisher (technique unavailable at OCAS at present),
- ...

However, as the etch quality is sufficient to determine the grain size and the superficial nature of the “smeared” layer could be illustrated by means of EBSD, it is considered that the currently applied techniques will allow a correct evaluation of the grain size of the material.

## 4 Processing details & results (per cast)

### 4.1 G106

G106 (w%)	C	Mn	Si	P	S	Ti	Cr	Ni	B	Mo
<b>Target</b>	0.0900	1.5000	0.8500	0.0400		0.4000	14.5000	15.5000	0.0050	1.5000
<b>Max</b>	0.1000	2.0000	0.9000	0.0500	0.0150	0.5000	16.0000	16.0000	0.0080	1.7000
<b>Min</b>	0.0800	1.0000	0.7000	0.0300		0.3000	14.0000	14.0000	0.0030	1.3000
<b>Realised</b>	0.0970	1.4494	0.7942	0.0400	0.0046	0.3841	15.0300	15.0300	0.0061	1.5018

	Al	Nb	Cu	W	Sn	O	N	Zr	V	Ca	Co
<b>Target</b>	0.0100	0.0000	0.0000	0.0000	0.0000		0.0000	0.0000	0.0000	0.0000	0.0000
<b>Max</b>	0.0150	0.0200	0.0300	0.0300	0.0000		0.0150	0.0300	0.0300	0.0300	0.0300
<b>Min</b>	0.0050	0.0000	0.0000	0.0000	0.0000		0.0000	0.0000	0.0000	0.0000	0.0000
<b>Realised</b>	0.0094	0.0104	0.0173	0.0118	0.0042	0.0038	0.0042	0.0000	0.0071	0.0000	0.0099

O content: 38 ppm

**Homogenization treatment:**  $T_{furnace} = 1230^{\circ}\text{C}$ ; In = 16u35 31/05; Out = 8u00 01/06

**Post-Hot rolling annealing:**

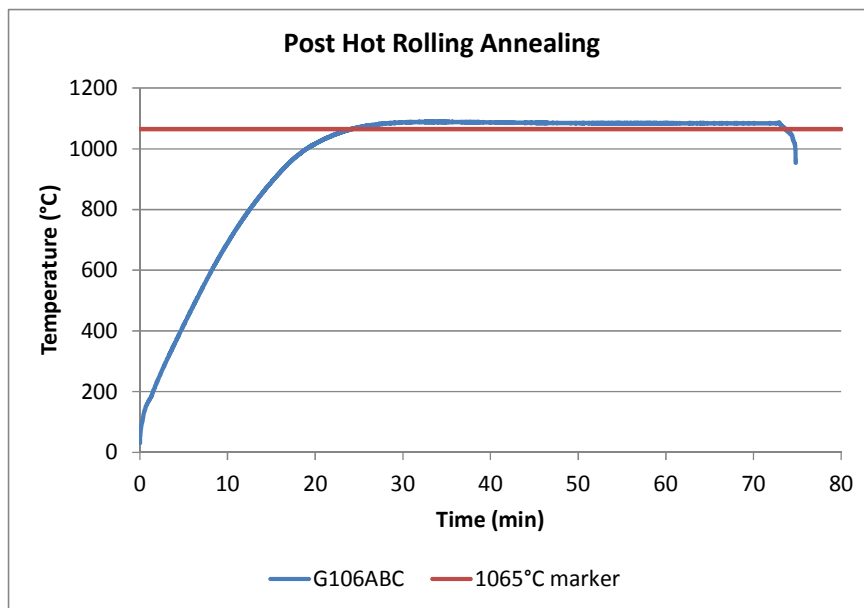

**Microstructure:** grain size (ASTM) = 8.96

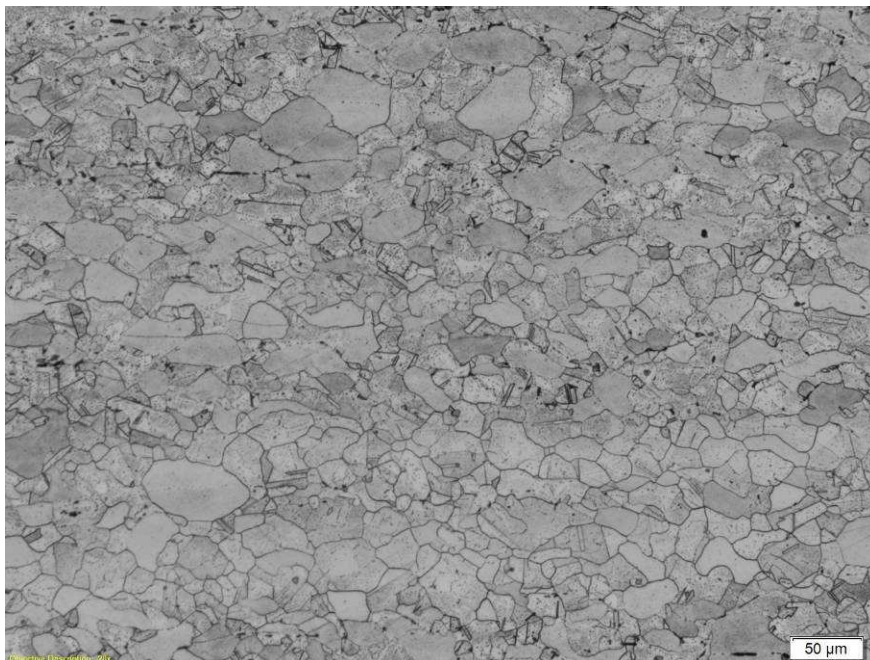

**Sheet dimensions (final product):**

<b><i>Sheet ID</i></b>	<b><i>Length (mm)</i></b>	<b><i>Width (mm)</i></b>	<b><i>Thickness (mm)</i></b>
G106A1C	320	260	15.1
G106A2C	315	260	15.1
G106B1C	315	260	15.1
G106B2C	310	260	15.1
G106C1C	310	260	15.1
G106C2C	295	260	15.2

**Remarks:**

None

## 4.2 G107

G107 (w%)	C	Mn	Si	P	S	Ti	Cr	Ni	B	Mo
Target	0.0900	1.5000	0.8500	0.0400		0.4000	14.5000	15.5000	0.0050	1.5000
Max	0.1000	2.0000	0.9000	0.0500	0.0150	0.5000	16.0000	16.0000	0.0080	1.7000
Min	0.0800	1.0000	0.7000	0.0300		0.3000	14.0000	14.0000	0.0030	1.3000
Realised	0.0970	1.6274	0.8805	0.0402	0.0041	0.4352	14.4700	15.2500	0.0066	1.5005

	Al	Nb	Cu	W	Sn	O	N	Zr	V	Ca	Co
Target	0.0100	0.0000	0.0000	0.0000	0.0000		0.0000	0.0000	0.0000	0.0000	0.0000
Max	0.0150	0.0200	0.0300	0.0300	0.0000		0.0150	0.0300	0.0300	0.0300	0.0300
Min	0.0050	0.0000	0.0000	0.0000	0.0000		0.0000	0.0000	0.0000	0.0000	0.0000
Realised	0.0138	0.0128	0.0294	0.0129	0.0061	0.0029	0.0047	0.0000	0.0158	0.0000	0.0081

O content: 29 ppm

**Homogenization treatment:**  $T_{\text{furnace}} = 1230^{\circ}\text{C}$ ; In = 16u35 31/05; Out = 8u00 01/06

**Post-Hot rolling annealing:**

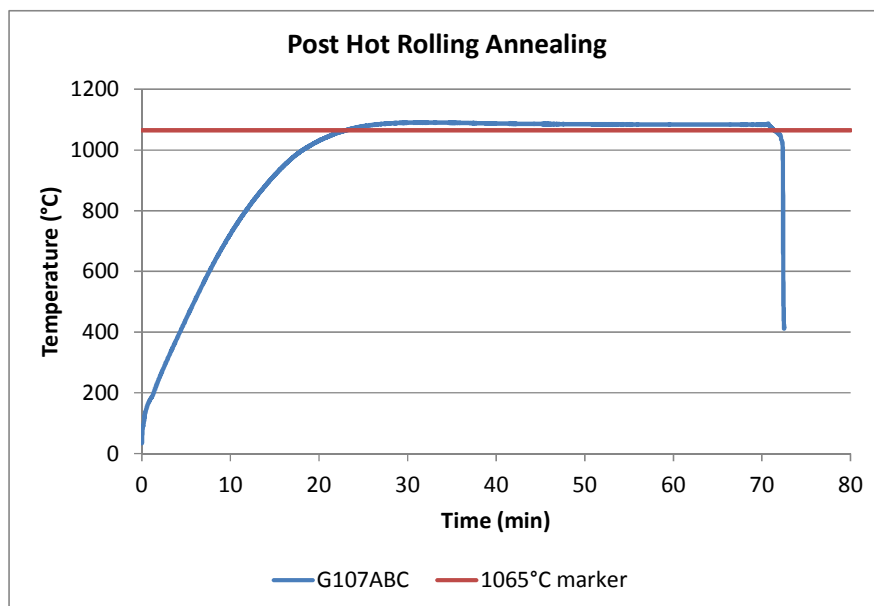

**Microstructure:** grain size (ASTM) = 8.01

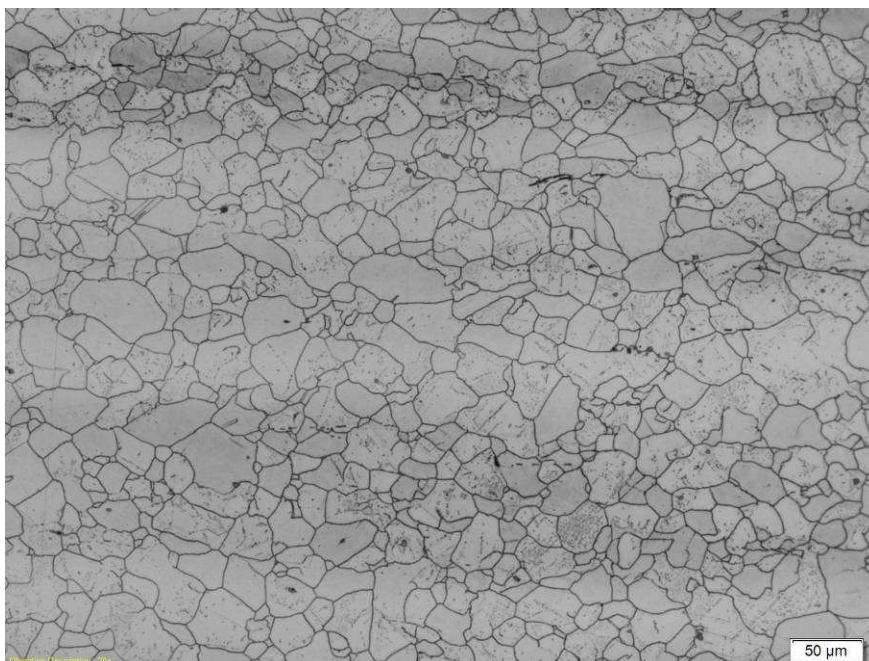

**Sheet dimensions (final product):**

<b><i>Sheet ID</i></b>	<b><i>Length (mm)</i></b>	<b><i>Width (mm)</i></b>	<b><i>Thickness (mm)</i></b>
G107A1C	335	260	15.1
G107A2C	355	260	15.1
G107B1C	355	260	15.1
G107B2C	350	260	15.0
G107C1C	270	260	15.0
G107C2C	285	260	15.1

**Remarks:**

None

**4.3 G108**

G108 (w%)	C	Mn	Si	P	S	Ti	Cr	Ni	B	Mo
Target	0.0900	1.5000	0.8500	0.0400		0.4000	14.5000	15.5000	0.0050	1.5000
Max	0.1000	2.0000	0.9000	0.0500	0.0150	0.5000	16.0000	16.0000	0.0080	1.7000
Min	0.0800	1.0000	0.7000	0.0300		0.3000	14.0000	14.0000	0.0030	1.3000
Realised	0.0941	1.5994	0.8657	0.0404	0.0046	0.4119	14.5700	15.3900	0.0063	1.5278

	Al	Nb	Cu	W	Sn	O	N	Zr	V	Ca	Co
Target	0.0100	0.0000	0.0000	0.0000	0.0000		0.0000	0.0000	0.0000	0.0000	0.0000
Max	0.0150	0.0200	0.0300	0.0300	0.0000		0.0150	0.0300	0.0300	0.0300	0.0300
Min	0.0050	0.0000	0.0000	0.0000	0.0000		0.0000	0.0000	0.0000	0.0000	0.0000
Realised	0.0108	0.0198	0.0261	0.0181	0.0061	0.0041	0.0051	0.0000	0.0127	0.0000	0.0091

O content: 41 ppm

**Homogenization treatment:** T<sub>furnace</sub> = 1230°C; In = 16u35 31/05; Out = 8u00 01/06

**Post-Hot rolling annealing:**

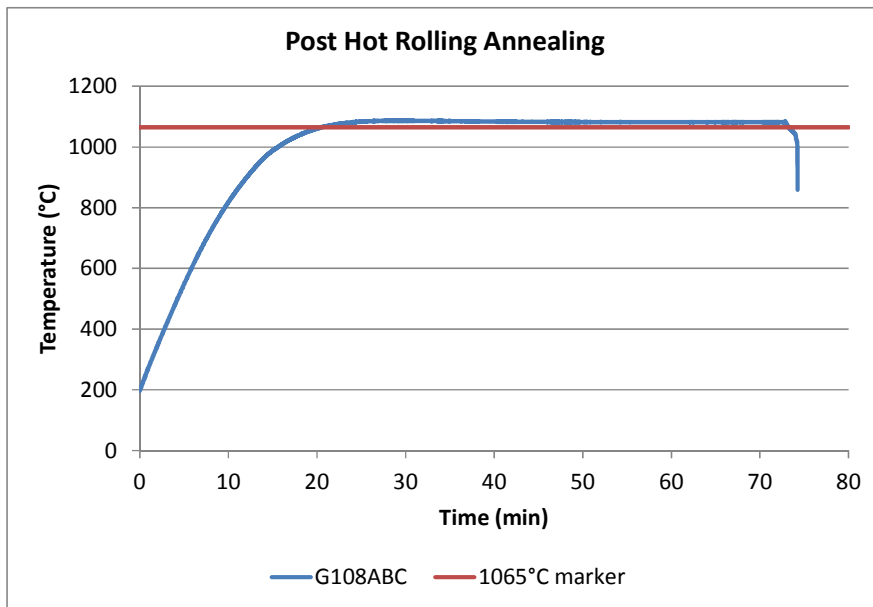

**Microstructure:** grain size (ASTM) = 8.36

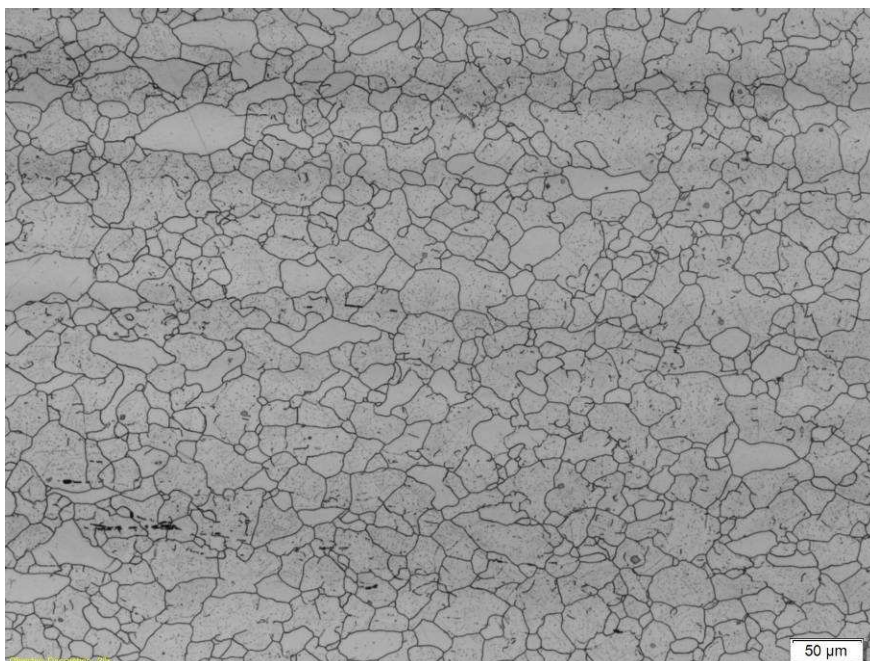



**Sheet dimensions (final product):**

<b><i>Sheet ID</i></b>	<b><i>Length (mm)</i></b>	<b><i>Width (mm)</i></b>	<b><i>Thickness (mm)</i></b>
G108A1C	350	260	15.1
G108A2C	330	260	15.2
G108B1C	340	260	15.1
G108B2C	355	260	15.1
G108C1C	215	260	15.1
G108C2C	205	260	15.1

**Remarks:**

None

**4.4 G109**

G109 (w%)	C	Mn	Si	P	S	Ti	Cr	Ni	B	Mo
Target	0.0900	1.5000	0.8500	0.0400		0.4000	14.5000	15.5000	0.0050	1.5000
Max	0.1000	2.0000	0.9000	0.0500	0.0150	0.5000	16.0000	16.0000	0.0080	1.7000
Min	0.0800	1.0000	0.7000	0.0300		0.3000	14.0000	14.0000	0.0030	1.3000
Realised	0.0977	1.6636	0.8309	0.0412	0.0040	0.4144	14.5900	15.3400	0.0063	1.5535

	Al	Nb	Cu	W	Sn	O	N	Zr	V	Ca	Co
Target	0.0100	0.0000	0.0000	0.0000	0.0000		0.0000	0.0000	0.0000	0.0000	0.0000
Max	0.0150	0.0200	0.0300	0.0300	0.0000		0.0150	0.0300	0.0300	0.0300	0.0300
Min	0.0050	0.0000	0.0000	0.0000	0.0000		0.0000	0.0000	0.0000	0.0000	0.0000
Realised	0.0102	0.0149	0.0232	0.0199	0.0044	0.0044	0.0051	0.0000	0.0113	0.0000	0.0081

O content: 44 ppm

**Homogenization treatment:** T<sub>furnace</sub> = 1230°C; In = 16u32 04/06; Out = 7u32 05/06

**Post-Hot rolling annealing:**

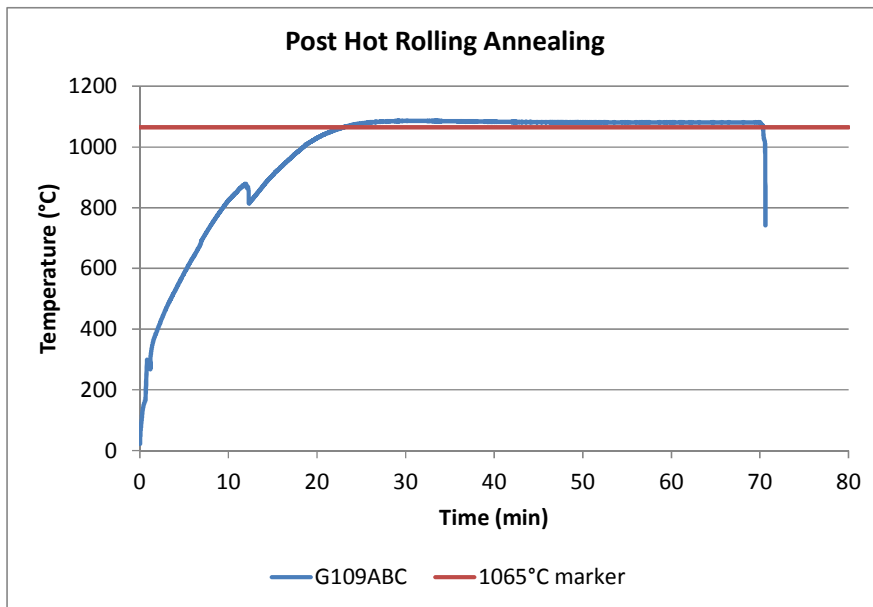

**Microstructure:** grain size (ASTM) = 8.24

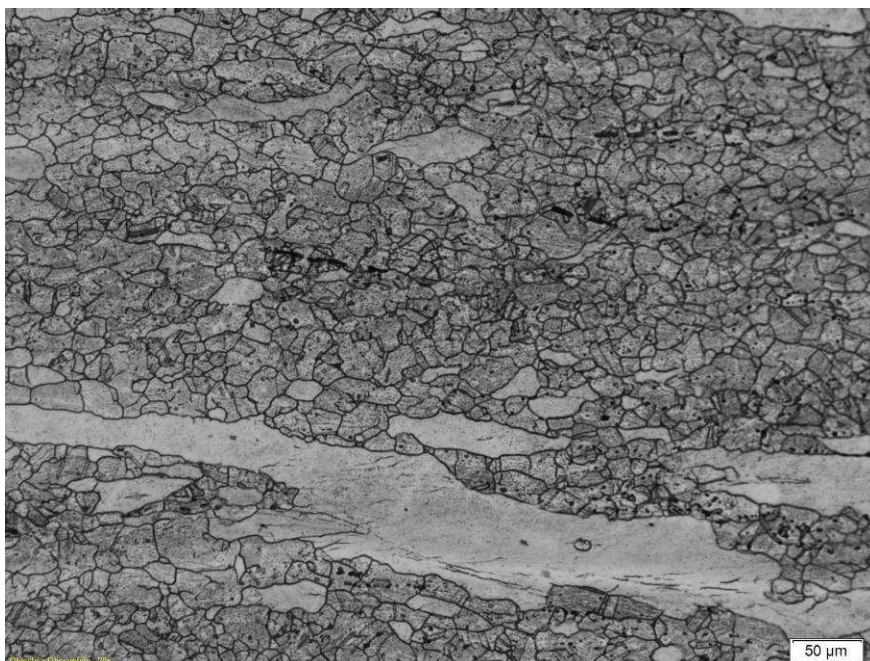

**Sheet dimensions (final product):**

<b><i>Sheet ID</i></b>	<b><i>Length (mm)</i></b>	<b><i>Width (mm)</i></b>	<b><i>Thickness (mm)</i></b>
G109A1C	585	135	15.1
G109A2C	575	135	15.1
G109B1C	585	135	15.1
G109B2C	600	135	15.1
G109C1C	595	135	15.1
G109C2C	590	135	15.1

**Remarks:**

None

## 4.5 G110

G110 (w%)	C	Mn	Si	P	S	Ti	Cr	Ni	B	Mo
Target	0.0900	1.5000	0.8500	0.0400		0.4000	14.5000	15.5000	0.0050	1.5000
Max	0.1000	2.0000	0.9000	0.0500	0.0150	0.5000	16.0000	16.0000	0.0080	1.7000
Min	0.0800	1.0000	0.7000	0.0300		0.3000	14.0000	14.0000	0.0030	1.3000
Realised	0.0980	1.4614	0.7908	0.0461	0.0049	0.3944	14.3714	15.8853	0.0068	1.4648

	Al	Nb	Cu	W	Sn	O	N	Zr	V	Ca	Co
Target	0.0100	0.0000	0.0000	0.0000	0.0000		0.0000	0.0000	0.0000	0.0000	0.0000
Max	0.0150	0.0200	0.0300	0.0300	0.0000		0.0150	0.0300	0.0300	0.0300	0.0300
Min	0.0050	0.0000	0.0000	0.0000	0.0000		0.0000	0.0000	0.0000	0.0000	0.0000
Realised	0.0079	0.0046	0.0218	0.0115	0.0035	0.0050	0.0052	0.0000	0.0134	0.0000	0.0082

O content: 50 ppm

**Homogenization treatment:**  $T_{\text{furnace}} = 1230^{\circ}\text{C}$ ; In = 16u32 04/06; Out = 7u32 05/06

**Post-Hot rolling annealing:**

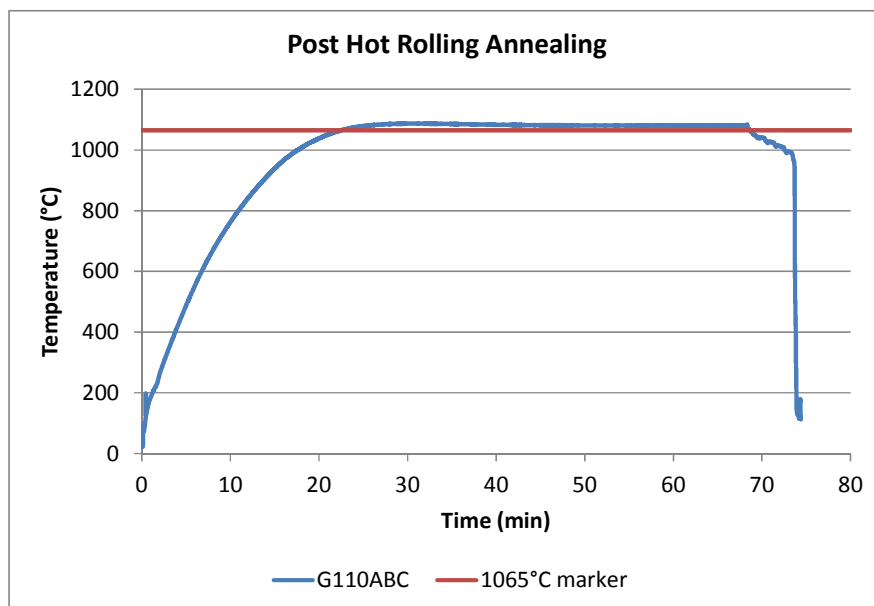

**Microstructure:** grain size (ASTM) = 8.88

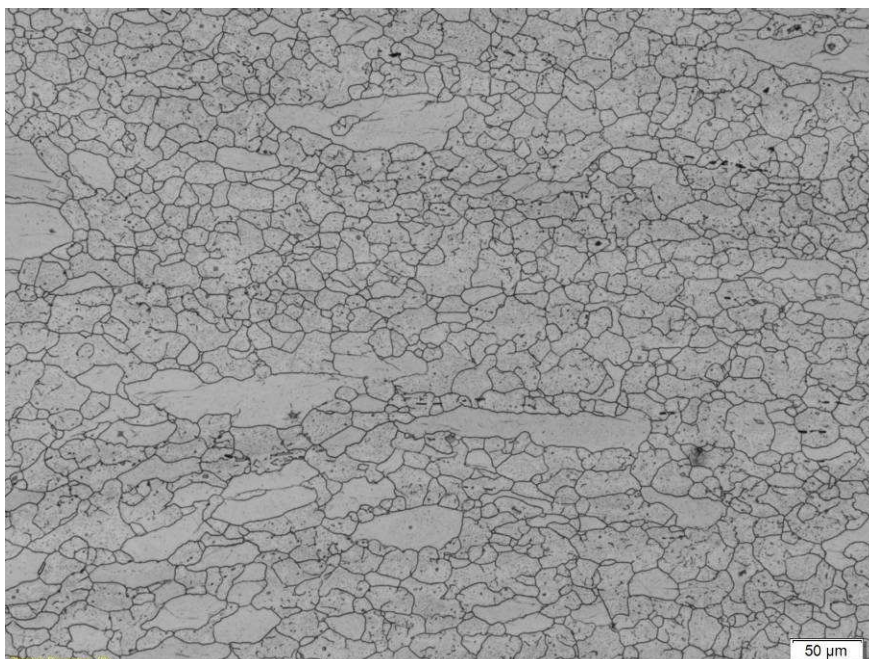

**Sheet dimensions (final product):**

<i>Sheet ID</i>	<i>Length (mm)</i>	<i>Width (mm)</i>	<i>Thickness (mm)</i>
G110A1C	590	135	15.1
G110A2C	590	135	15.1
G110B1C	595	135	15.0
G110B2C	595	135	15.1
G110C1C	600	135	15.0
G110C2C	600	135	15.0

**Remarks:**

There is a thin sheet of carbon steel inside sheet G110A. The position of the thin sheet of carbon sheet is illustrated below (cross-section view of the strip) by a green line. The carbon steel strip is expected to be present over the full length of strips G110A1C and G110A2C. It is visible by the bare eye on the cut-edge when the sheet is cut.

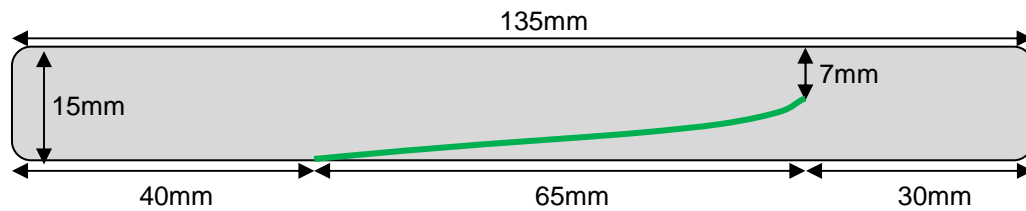

During each lab cast, a carbon steel strip (bottom-plate) is placed on the bottom of the ingot in order to protect the inside of the ingot against the liquid steel. The protective coating is placed both below and above this thin carbon sheet, gluing it to the bottom inside of the ingot. However, very rarely it gets detached during the casting of the liquid steel from the crucible into the ingot and gets trapped in the cast steel block.

During the cutting of the ingot, the absence of the bottom-plate was not noticed. The defect was only observed after cutting the sample for metallography out of the middle of the hot rolled, annealed and quenched sheet.

**4.6 G111**

G111 (w%)	C	Mn	Si	P	S	Ti	Cr	Ni	B	Mo
<b>Target</b>	0.0900	1.5000	0.8500	0.0400		0.4000	14.5000	15.5000	0.0050	1.5000
<b>Max</b>	0.1000	2.0000	0.9000	0.0500	0.0150	0.5000	16.0000	16.0000	0.0080	1.7000
<b>Min</b>	0.0800	1.0000	0.7000	0.0300		0.3000	14.0000	14.0000	0.0030	1.3000
<b>Realised</b>	0.0910	1.4920	0.8399	0.0379	0.0050	0.3976	14.0736	15.7137	0.0074	1.4893

	Al	Nb	Cu	W	Sn	O	N	Zr	V	Ca	Co
<b>Target</b>	0.0100	0.0000	0.0000	0.0000	0.0000		0.0000	0.0000	0.0000	0.0000	0.0000
<b>Max</b>	0.0150	0.0200	0.0300	0.0300	0.0000		0.0150	0.0300	0.0300	0.0300	0.0300
<b>Min</b>	0.0050	0.0000	0.0000	0.0000	0.0000		0.0000	0.0000	0.0000	0.0000	0.0000
<b>Realised</b>	0.0090	0.0060	0.0242	0.0129	0.0051	0.0045	0.0046	0.0000	0.0136	0.0000	0.0098

O content: 45 ppm

**Homogenization treatment:** T<sub>furnace</sub> = 1230°C; In = 16u32 04/06; Out = 7u32 05/06

**Post-Hot rolling annealing:**

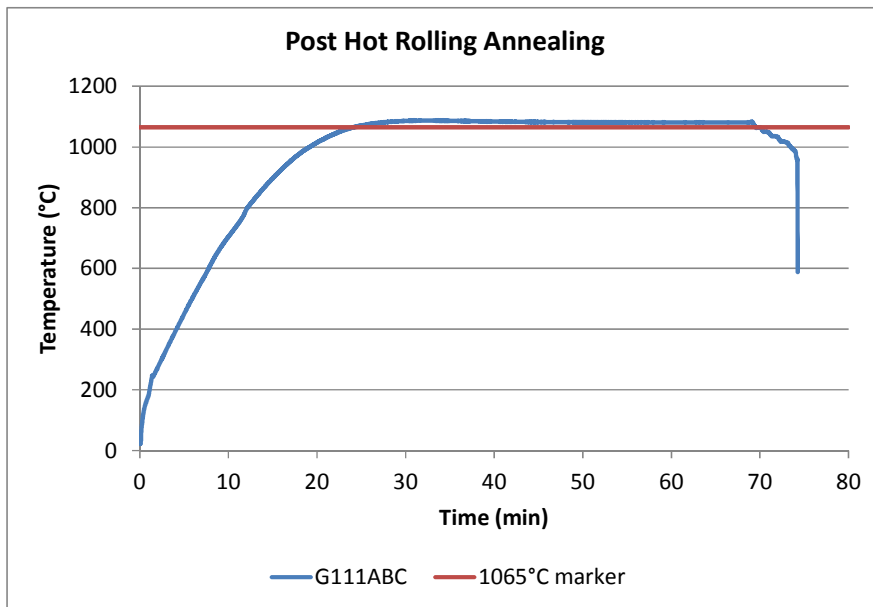

**Microstructure:** grain size (ASTM) = 8.48

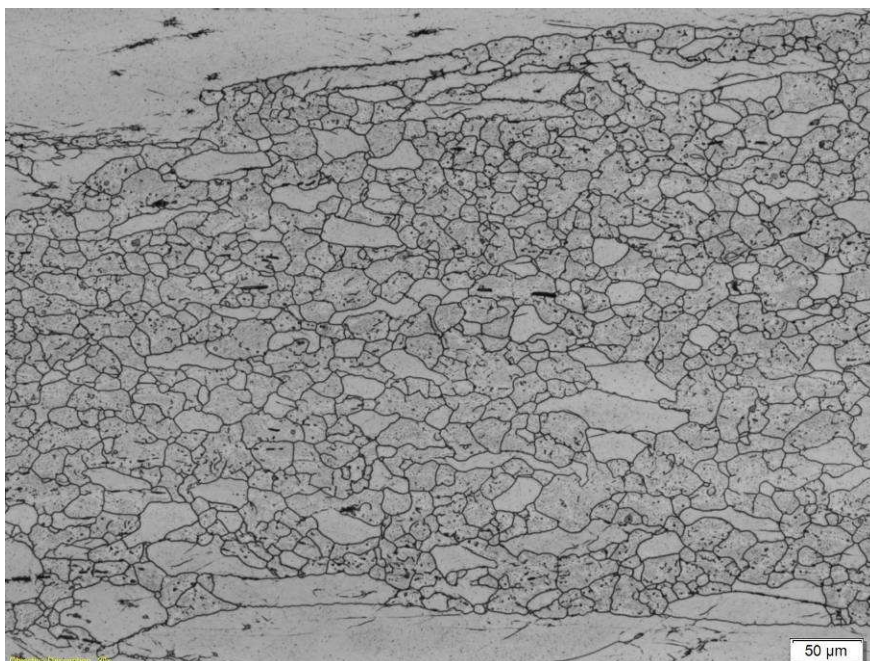

**Sheet dimensions (final product):**

<b><i>Sheet ID</i></b>	<b><i>Length (mm)</i></b>	<b><i>Width (mm)</i></b>	<b><i>Thickness (mm)</i></b>
G111A1C	585	135	15.1
G111A2C	595	135	15.1
G111B1C	595	135	15.0
G111B2C	595	135	15.0
G111C1C	610	135	15.1
G111C2C	600	135	15.1

**Remarks:**

None

**4.7 G112**

<b>G112 (w%)</b>	C	Mn	Si	P	S	Ti	Cr	Ni	B	Mo
<b>Target</b>	0.0900	1.5000	0.8500	0.0400		0.4000	14.5000	15.5000	0.0050	1.5000
<b>Max</b>	0.1000	2.0000	0.9000	0.0500	0.0150	0.5000	16.0000	16.0000	0.0080	1.7000
<b>Min</b>	0.0800	1.0000	0.7000	0.0300		0.3000	14.0000	14.0000	0.0030	1.3000
<b>Realised</b>	0.0920	1.4685	0.7818	0.0417	0.0061	0.3852	14.2945	15.8466	0.0060	1.4309

	Al	Nb	Cu	W	Sn	O	N	Zr	V	Ca	Co
<b>Target</b>	0.0100	0.0000	0.0000	0.0000	0.0000		0.0000	0.0000	0.0000	0.0000	0.0000
<b>Max</b>	0.0150	0.0200	0.0300	0.0300	0.0000		0.0150	0.0300	0.0300	0.0300	0.0300
<b>Min</b>	0.0050	0.0000	0.0000	0.0000	0.0000		0.0000	0.0000	0.0000	0.0000	0.0000
<b>Realised</b>	0.0077	0.0061	0.0185	0.0143	0.0032	0.0018	0.0051	0.0000	0.0093	0.0000	0.0083

**O content: 18 ppm**



**4.8 G113**

G113 (w%)	C	Mn	Si	P	S	Ti	Cr	Ni	B	Mo
<b>Target</b>	0.0900	1.5000	0.8500	0.0400		0.4000	14.5000	15.5000	0.0050	1.5000
<b>Max</b>	0.1000	2.0000	0.9000	0.0500	0.0150	0.5000	16.0000	16.0000	0.0080	1.7000
<b>Min</b>	0.0800	1.0000	0.7000	0.0300		0.3000	14.0000	14.0000	0.0030	1.3000
<b>Realised</b>	0.0870	1.4496	0.7374	0.0424	0.0050	0.3636	14.1739	15.5487	0.0063	1.5371

	Al	Nb	Cu	W	Sn	O	N	Zr	V	Ca	Co
<b>Target</b>	0.0100	0.0000	0.0000	0.0000	0.0000		0.0000	0.0000	0.0000	0.0000	0.0000
<b>Max</b>	0.0150	0.0200	0.0300	0.0300	0.0000		0.0150	0.0300	0.0300	0.0300	0.0300
<b>Min</b>	0.0050	0.0000	0.0000	0.0000	0.0000		0.0000	0.0000	0.0000	0.0000	0.0000
<b>Realised</b>	0.0076	0.0048	0.0219	0.0194	0.0032	0.0035	0.0045	0.0000	0.0121	0.0000	0.0095

**O content: 35 ppm**

**4.9 G114**

<b>G114 (w%)</b>	C	Mn	Si	P	S	Ti	Cr	Ni	B	Mo
<b>Target</b>	0.0900	1.5000	0.8500	0.0400		0.4000	14.5000	15.5000	0.0050	1.5000
<b>Max</b>	0.1000	2.0000	0.9000	0.0500	0.0150	0.5000	16.0000	16.0000	0.0080	1.7000
<b>Min</b>	0.0800	1.0000	0.7000	0.0300		0.3000	14.0000	14.0000	0.0030	1.3000
<b>Realised</b>	0.0860	1.5060	0.7810	0.0440	0.0044	0.4180	14.1500	15.3500	0.0070	1.4980

	Al	Nb	Cu	W	Sn	O	N	Zr	V	Ca	Co
<b>Target</b>	0.0100	0.0000	0.0000	0.0000	0.0000		0.0000	0.0000	0.0000	0.0000	0.0000
<b>Max</b>	0.0150	0.0200	0.0300	0.0300	0.0000		0.0150	0.0300	0.0300	0.0300	0.0300
<b>Min</b>	0.0050	0.0000	0.0000	0.0000	0.0000		0.0000	0.0000	0.0000	0.0000	0.0000
<b>Realised</b>	0.0095	0.0069	0.0260	0.0129	0.0048	0.0029	0.0055	0.0000	0.0132	0.0000	0.0096

**O content: 29 ppm**

**4.10 G115**

<b>G115 (w%)</b>	C	Mn	Si	P	S	Ti	Cr	Ni	B	Mo
<b>Target</b>	0.0900	1.5000	0.8500	0.0400		0.4000	14.5000	15.5000	0.0050	1.5000
<b>Max</b>	0.1000	2.0000	0.9000	0.0500	0.0150	0.5000	16.0000	16.0000	0.0080	1.7000
<b>Min</b>	0.0800	1.0000	0.7000	0.0300		0.3000	14.0000	14.0000	0.0030	1.3000
<b>Realised</b>	0.0920	1.4920	0.7691	0.0430	0.0057	0.4180	14.4790	15.4270	0.0072	1.5257

	Al	Nb	Cu	W	Sn	O	N	Zr	V	Ca	Co
<b>Target</b>	0.0100	0.0000	0.0000	0.0000	0.0000		0.0000	0.0000	0.0000	0.0000	0.0000
<b>Max</b>	0.0150	0.0200	0.0300	0.0300	0.0000		0.0150	0.0300	0.0300	0.0300	0.0300
<b>Min</b>	0.0050	0.0000	0.0000	0.0000	0.0000		0.0000	0.0000	0.0000	0.0000	0.0000
<b>Realised</b>	0.0083	0.0062	0.0230	0.0190	0.0040	0.0046	0.0045	0.0000	0.0135	0.0000	0.0087

**O content: 46 ppm**

**4.11 G116**

<b>G116 (w%)</b>	C	Mn	Si	P	S	Ti	Cr	Ni	B	Mo
<b>Target</b>	0.0900	1.5000	0.8500	0.0400		0.4000	14.5000	15.5000	0.0050	1.5000
<b>Max</b>	0.1000	2.0000	0.9000	0.0500	0.0150	0.5000	16.0000	16.0000	0.0080	1.7000
<b>Min</b>	0.0800	1.0000	0.7000	0.0300		0.3000	14.0000	14.0000	0.0030	1.3000
<b>Realised</b>	0.0925	1.5060	0.7619	0.0420	0.0052	0.4199	14.3536	15.6417	0.0067	1.5436

	Al	Nb	Cu	W	Sn	O	N	Zr	V	Ca	Co
<b>Target</b>	0.0100	0.0000	0.0000	0.0000	0.0000		0.0000	0.0000	0.0000	0.0000	0.0000
<b>Max</b>	0.0150	0.0200	0.0300	0.0300	0.0000		0.0150	0.0300	0.0300	0.0300	0.0300
<b>Min</b>	0.0050	0.0000	0.0000	0.0000	0.0000		0.0000	0.0000	0.0000	0.0000	0.0000
<b>Realised</b>	0.0090	0.0077	0.0166	0.0136	0.0032	0.0051	0.0050	0.0000	0.0133	0.0000	0.0092

**O content: 51 ppm**

**4.12 G117**

<b>G117 (w%)</b>	C	Mn	Si	P	S	Ti	Cr	Ni	B	Mo
<b>Target</b>	0.0900	1.5000	0.8500	0.0400		0.4000	14.5000	15.5000	0.0050	1.5000
<b>Max</b>	0.1000	2.0000	0.9000	0.0500	0.0150	0.5000	16.0000	16.0000	0.0080	1.7000
<b>Min</b>	0.0800	1.0000	0.7000	0.0300		0.3000	14.0000	14.0000	0.0030	1.3000
<b>Realised</b>	0.0830	1.4440	0.7341	0.0420	0.0041	0.3630	14.2800	15.8300	0.0066	1.5100

	Al	Nb	Cu	W	Sn	O	N	Zr	V	Ca	Co
<b>Target</b>	0.0100	0.0000	0.0000	0.0000	0.0000		0.0000	0.0000	0.0000	0.0000	0.0000
<b>Max</b>	0.0150	0.0200	0.0300	0.0300	0.0000		0.0150	0.0300	0.0300	0.0300	0.0300
<b>Min</b>	0.0050	0.0000	0.0000	0.0000	0.0000		0.0000	0.0000	0.0000	0.0000	0.0000
<b>Realised</b>	0.0104	0.0045	0.0180	0.0150	0.0038	0.0045	0.0061	0.0000	0.0107	0.0000	0.0092

**O content: 45 ppm**

**4.13 G118**

<b>G118 (w%)</b>	C	Mn	Si	P	S	Ti	Cr	Ni	B	Mo
<b>Target</b>	0.0900	1.5000	0.8500	0.0400		0.4000	14.5000	15.5000	0.0050	1.5000
<b>Max</b>	0.1000	2.0000	0.9000	0.0500	0.0150	0.5000	16.0000	16.0000	0.0080	1.7000
<b>Min</b>	0.0800	1.0000	0.7000	0.0300		0.3000	14.0000	14.0000	0.0030	1.3000
<b>Realised</b>	0.0852	1.4634	0.7332	0.0410	0.0045	0.4032	14.3470	15.8888	0.0066	1.5158

	Al	Nb	Cu	W	Sn	O	N	Zr	V	Ca	Co
<b>Target</b>	0.0100	0.0000	0.0000	0.0000	0.0000		0.0000	0.0000	0.0000	0.0000	0.0000
<b>Max</b>	0.0150	0.0200	0.0300	0.0300	0.0000		0.0150	0.0300	0.0300	0.0300	0.0300
<b>Min</b>	0.0050	0.0000	0.0000	0.0000	0.0000		0.0000	0.0000	0.0000	0.0000	0.0000
<b>Realised</b>	0.0082	0.0054	0.0116	0.0166	0.0021	0.0024	0.0039	0.0000	0.0124	0.0000	0.0070

**O content: 24 ppm**

**4.14 G119**

<b>G119 (w%)</b>	C	Mn	Si	P	S	Ti	Cr	Ni	B	Mo
<b>Target</b>	0.0900	1.5000	0.8500	0.0400		0.4000	14.5000	15.5000	0.0050	1.5000
<b>Max</b>	0.1000	2.0000	0.9000	0.0500	0.0150	0.5000	16.0000	16.0000	0.0080	1.7000
<b>Min</b>	0.0800	1.0000	0.7000	0.0300		0.3000	14.0000	14.0000	0.0030	1.3000
<b>Realised</b>	0.0858	1.4646	0.7414	0.0443	0.0048	0.3903	14.4368	15.7647	0.0066	1.4957

	Al	Nb	Cu	W	Sn	O	N	Zr	V	Ca	Co
<b>Target</b>	0.0100	0.0000	0.0000	0.0000	0.0000		0.0000	0.0000	0.0000	0.0000	0.0000
<b>Max</b>	0.0150	0.0200	0.0300	0.0300	0.0000		0.0150	0.0300	0.0300	0.0300	0.0300
<b>Min</b>	0.0050	0.0000	0.0000	0.0000	0.0000		0.0000	0.0000	0.0000	0.0000	0.0000
<b>Realised</b>	0.0082	0.0064	0.0196	0.0188	0.0020	0.0020	0.0060	0.0000	0.0112	0.0000	0.0096

**O content: 20 ppm**

**4.15 G120**

G120 (w%)	C	Mn	Si	P	S	Ti	Cr	Ni	B	Mo
<b>Target</b>	0.0900	1.5000	0.8500	0.0400		0.4000	14.5000	15.5000	0.0050	1.5000
<b>Max</b>	0.1000	2.0000	0.9000	0.0500	0.0150	0.5000	16.0000	16.0000	0.0080	1.7000
<b>Min</b>	0.0800	1.0000	0.7000	0.0300		0.3000	14.0000	14.0000	0.0030	1.3000
<b>Realised</b>	0.0860	1.4742	0.7382	0.0439	0.0060	0.4097	14.4116	15.8282	0.0064	1.5041

	Al	Nb	Cu	W	Sn	O	N	Zr	V	Ca	Co
<b>Target</b>	0.0100	0.0000	0.0000	0.0000	0.0000		0.0000	0.0000	0.0000	0.0000	0.0000
<b>Max</b>	0.0150	0.0200	0.0300	0.0300	0.0000		0.0150	0.0300	0.0300	0.0300	0.0300
<b>Min</b>	0.0050	0.0000	0.0000	0.0000	0.0000		0.0000	0.0000	0.0000	0.0000	0.0000
<b>Realised</b>	0.0075	0.0061	0.0177	0.0136	0.0034	0.0024	0.0051	0.0000	0.0099	0.0000	0.0100

**O content: 24 ppm**



**4.16 G121**

<b>G121 (w%)</b>	C	Mn	Si	P	S	Ti	Cr	Ni	B	Mo
<b>Target</b>	0.0900	1.5000	0.8500	0.0400		0.4000	14.5000	15.5000	0.0050	1.5000
<b>Max</b>	0.1000	2.0000	0.9000	0.0500	0.0150	0.5000	16.0000	16.0000	0.0080	1.7000
<b>Min</b>	0.0800	1.0000	0.7000	0.0300		0.3000	14.0000	14.0000	0.0030	1.3000
<b>Realised</b>	0.0811	1.4894	0.7535	0.0396	0.0050	0.4065	14.5423	15.8875	0.0065	1.4626

	Al	Nb	Cu	W	Sn	O	N	Zr	V	Ca	Co
<b>Target</b>	0.0100	0.0000	0.0000	0.0000	0.0000		0.0000	0.0000	0.0000	0.0000	0.0000
<b>Max</b>	0.0150	0.0200	0.0300	0.0300	0.0000		0.0150	0.0300	0.0300	0.0300	0.0300
<b>Min</b>	0.0050	0.0000	0.0000	0.0000	0.0000		0.0000	0.0000	0.0000	0.0000	0.0000
<b>Realised</b>	0.0082	0.0066	0.0209	0.0130	0.0026	0.0023	0.0048	0.0000	0.0120	0.0000	0.0083

**O content: 23 ppm**

## 4.17 G122

G122 (w%)	C	Mn	Si	P	S	Ti	Cr	Ni	B	Mo
<b>Target</b>	0.0900	1.5000	0.8500	0.0400		0.4000	14.5000	15.5000	0.0050	1.5000
<b>Max</b>	0.1000	2.0000	0.9000	0.0500	0.0150	0.5000	16.0000	16.0000	0.0080	1.7000
<b>Min</b>	0.0800	1.0000	0.7000	0.0300		0.3000	14.0000	14.0000	0.0030	1.3000
<b>Realised</b>	0.0780	1.4860	0.7711	0.0401	0.0059	0.4062	14.5091	15.8774	0.0066	1.5093

	Al	Nb	Cu	W	Sn	O	N	Zr	V	Ca	Co
<b>Target</b>	0.0100	0.0000	0.0000	0.0000	0.0000		0.0000	0.0000	0.0000	0.0000	0.0000
<b>Max</b>	0.0150	0.0200	0.0300	0.0300	0.0000		0.0150	0.0300	0.0300	0.0300	0.0300
<b>Min</b>	0.0050	0.0000	0.0000	0.0000	0.0000		0.0000	0.0000	0.0000	0.0000	0.0000
<b>Realised</b>	0.0079	0.0067	0.0206	0.0191	0.0037	0.0021	0.0048	0.0000	0.0105	0.0000	0.0086

O content: 21 ppm

## Evaluation

Dear Client,

Your satisfaction is our main concern. You are invited to give your opinion by filling in the form on:

<http://www.ocas.be/forms/evaluationsheetTSS.aspx>

Thank you very much for your contribution to our quality improvement.

Your OCAS Team

## Contact information

<b>Contact name</b>	Nico De Wispelaere
<b>Contact tel</b>	09/345.12. 39
<b>Contact e-mail</b>	Nico.dewispelaere@ocas.be
<b>Report Date</b>	13/06/2012

Sylvia De Vrieze, Nico De Wispelaere	Xavier Veys	Nico De Wispelaere
Author(s)	Reviewer	Management

THE RESULTS IN THE REPORT ARE ONLY VALID FOR THE TESTED OBJECTS. NOTHING OF THIS TEXT AND/OR ITS APPENDICES MAY BE REPRODUCED WITHOUT EXPLICIT AUTHORISATION OF OCAS